



MEYLE[®]
Products



Spare Parts

for trucks



DAF

1 Engine/Cooling
Belt drive / Engine control • Cooling system • Engine • Fuel system
Lubrication system

2 Brakes
Air system • Brakes • Disc brake

3 Drive train/Transmission/Clutch
Axle shafts • Clutch • Transmission

4 Suspension
Control arms • Stabilizer • Stub axle • Suspension / damping
Wheel hubs / Wheel bearings

5 Steering
Hydraulics • Tie rod assemblies

6 Body/Cabin
Body • Cabin • Interior fittings

Index **MEYLE no.** → **Ref. no.**

Index **Ref. no.** → **MEYLE no.**

Engine/Cooling

1
Belt drive / Engine control, Cooling system, Engine, Fuel system, Lubrication system

Air filter	Hand primer pump	Thermostat
Belt tensioner	Oil filter	V-belt
Expansion tank	Radiator fan motor	Voltage regulator
Expansion tank cap	Repair kit, fuel pump	V-ribbed belt
Fan blade	Sensor, boost pressure	Water pump
Fan clutch	Sensor, coolant level	
Fuel filter	Tension roller, ribbed belt	

Brakes

38
Air system, Brakes, Disc brake

ABS wheel sensor	Check valve	Multiway valve
Air dryer cartridge	Connecting Cable, ABS	Relay valve
Air suspension valve	Control valve, trailer	Repair kit, brake caliper
Brake disc	Cylinder head, compressor	Sensor, pneumatic suspension level
Brake line coupling	Diaphragm, brake cylinder	Slave cylinder
Brake pad set	Line filter, compressor system	Valve, compressor system

Drive train/Transmission/Clutch

58
Axle shafts, Clutch, Transmission

Clutch booster	Neutral safety switch	Switch, splitter gearbox
Joint, propeller shaft	Shift rod connector	

Suspension

63
Control arms, Stabilizer, Stub axle, Suspension / damping, Wheel hubs / Wheel bearings

Bushing, leaf spring	Mount, stabilizer	Rod/strut, suspension
Bushing, stabilizer	Repair kit, control arm	Rubber stop, suspension
Control arm	Repair kit, kingpin	Wheel bearing
Mount, leaf spring	Repair kit, stabilizer bushing	Wheel bearing kit

Steering

82
Hydraulics, Tie rod assemblies

Hydraulic filter, steering system	Tie rod end
Hydraulic pump, P/S	

Body/Cabin

90
Body, Cabin, Interior fittings

Bushing, driver cab suspension	Ignition lock cylinder	Tilt cylinder, driver cab
Cabin air filter	Repair kit, driver cab mounting	Tilt pump, driver cab
Gear shift knob	Spacer, driver cab stabiliser	Wiper Blade



Voltage regulator
034 015 0005
 0068 499

Notes

Voltage [V] 28

References

 0068 499 68499
 068499

Application info

85 (07/92-02/98)

95 (09/87-01/98)

Sensor, boost pressure
12-34 899 0004
 1697 325

Notes

 Operating voltage [V] 24
 Number of Poles 4
 Piezoelectric Sensor

References

1697 325

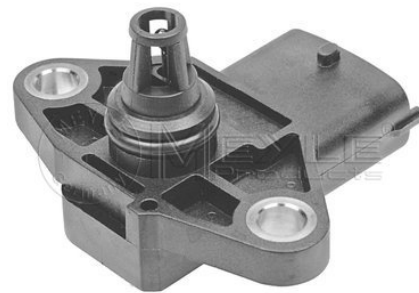
Application info

 95 XF (01/97-09/02)
 CF 75 (01/01--)

CF 85 (01/01--)

Oil filter
14-34 018 0010
 0211 340

Notes

 Inner Diameter [mm] 24
 Outer Diameter [mm] 84
 Height [mm] 134
 without gasket / seal
 Filter Insert

References

 0211 340 236481
 211340 0236 481



1

14-34 018 0010
0211 340

Oil filter

Application info

F 1100 (01/78-11/90)
F 1200 (01/69-12/81)
F 1400 (02/72-12/81)
F 1500 (-08/91)

F 1600 (01/70-08/91)
F 2100 (07/78-08/91)
F 900 (01/75-11/88)

14-34 018 0011
0267 714

Oil filter



Notes

	with seal
Inner Diameter [mm]	111
Inner Diameter [mm]	100
Outer Diameter [mm]	136
Height [mm]	308
Thread Size	1 1/2-16 UN
	Screw-on Filter

References

0267 714	267714
----------	--------

Application info

85 (07/92-02/98)
95 (09/87-01/98)

F 2900 (01/90-10/93)
F 3200 (01/90-10/93)

14-34 018 0012
0611 049

Oil filter



Notes

	with seal
Inner Diameter [mm]	71
Inner Diameter [mm]	62
Outer Diameter [mm]	93
Height [mm]	170
Thread Size	1-12 UNF
	Screw-on Filter

References

0611 049	661049
611049	0661 049

Application info

F 2100 (07/78-08/91)
F 2200 (01/71-11/80)

F 2300 (07/78-10/93)
F 2500 (02/82-08/91)

14-34 322 0001
 1310 901

Oil filter
Notes

	with seal
Inner Diameter [mm]	111
Inner Diameter [mm]	101
Outer Diameter [mm]	136
Height [mm]	308
Thread Size	M 42x2
	Screw-on Filter

References

1310 901

Application info

85 CF (02/98-12/00)

95 XF (01/97-09/02)

14-34 018 0001
 1397 764

Oil filter
Notes

	with seal
Inner Diameter [mm]	56
Outer Diameter [mm]	112.5
Height [mm]	150
	Filter Insert

References

1397 764

Application info

CF 75 (01/01--)

CF 85 (01/01--)

XF 95 (09/02-12/06)

14-34 018 0007
 1399 494

Oil filter
Notes

	with seal
Inner Diameter [mm]	62
Outer Diameter [mm]	93.5
Height [mm]	174
Thread Size	M27x2
	Screw-on Filter

References

1399 494

Application info

CF 65 (01/01--)

LF 45 (01/01--)

LF 55 (01/01--)



1

14-34 018 0013
1629 393

Oil filter



Notes

Inner Diameter [mm]	with seal
Outer Diameter [mm]	56
Height [mm]	113
	220
	Filter Insert

References

1629 393	1643 070G
1643 070	1948 921G
1948 921	

Application info

CF 85 (01/01--)

XF 105 (10/05--)

012 094 0024
0265 045

Air filter



Notes

Inner Diameter [mm]	103
Outer Diameter [mm]	198
Height [mm]	365
	Filter Insert

References

0265 045	265045
----------	--------

Application info

85 (07/92-02/98)

95 (09/87-01/98)

12-34 321 0004
0692 380

Air filter



Notes

Inner Diameter [mm]	93
Inner Diameter [mm]	17
Outer Diameter [mm]	111
Height [mm]	372
	Filter Insert

References

0692 380	692380
----------	--------

Application info

F 2700 (01/90-10/93)
F 2800 (01/74-09/91)

F 3600 (06/85-09/91)

14-34 321 0007
 0693 076

Air filter
Notes

Inner Diameter [mm]	101
Outer Diameter [mm]	213
Height [mm]	316
	Filter Insert

References

0693 076	693096
693076	0693 096

Application info

F 1300 (07/78-12/92)	F 1500 (--08/91)
----------------------	------------------

14-12 321 0009
 APUC43

Air filter
Notes

Inner Diameter [mm]	124
Outer Diameter [mm]	214
Height [mm]	339
	Filter Insert

References

APUC43	1667 999
1433 690	1672 463
1644 642	

Application info

LF 45 (01/01--)	LF 55 (01/01--)
-----------------	-----------------

812 321 0001
 1207 748

Air filter
Notes

Inner Diameter [mm]	190.5
Outer Diameter [mm]	302
Height [mm]	365
	Filter Insert

References

0667 078	1207 748
667078	

Application info

85 (07/92-02/98)	95 XF (01/97-09/02)
85 CF (02/98-12/00)	F 2900 (01/90-10/93)
95 (09/87-01/98)	F 3200 (01/90-10/93)



1

14-34 321 0008
1317 409

Air filter



Notes

Inner Diameter [mm]	148
Outer Diameter [mm]	282
Height [mm]	481
	Filter Insert

References

1317 409

Application info

75 CF (02/98-12/00)
85 CF (02/98-12/00)

CF 85 (01/01--)

14-34 321 0003
1318 919

Air filter

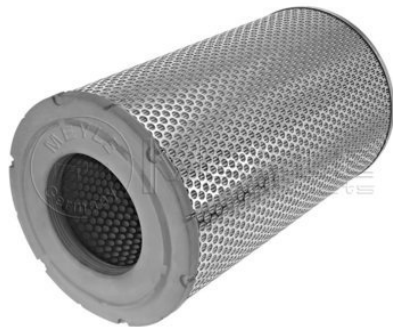

Notes

Inner Diameter [mm]	129
Outer Diameter [mm]	243
Height [mm]	420
	Filter Insert

References

0754 718	1314 531
754 718	1318 919

Application info

65 (03/93-02/98)
75 (07/92-02/98)
85 (07/92-02/98)

85 CF (02/98-12/00)
F 1000 (12/86-12/92)
F 800 (12/86-08/91)

14-34 321 0010
1385 791

Air filter



Notes

Inner Diameter [mm]	125
Outer Diameter [mm]	246
Height [mm]	443
	Filter Insert

References

1346 885	1385 791
----------	----------



Air filter
14-34 321 0010
 1385 791

Application info

65 CF (02/98-12/00)

75 CF (02/98-12/00)

Air filter
14-34 321 0006
 1433 697

Notes

Inner Diameter [mm]	124
Outer Diameter [mm]	214
Height [mm]	417
	Filter Insert

References

1433 697	1672 464
1644 641	APUC944
1668 000	

Application info

LF 45 (01/01--)

LF 55 (01/01--)

Air filter
14-12 321 0001
 1638 054

Notes

Inner Diameter [mm]	147
Outer Diameter [mm]	281
Height [mm]	510
	Filter Insert

References

1638 054

Application info

XF 105 (10/05--)



1

<p>14-12 321 0007 1657 522</p>		<p>Air filter</p>	
		<p>Notes</p> <p>Inner Diameter [mm] 170 Outer Diameter [mm] 267 Height [mm] 420 Filter Insert</p>	
		<p>References</p> <p>1363 023 1657 522 1363 025 1726 061 1638 026 1789 292 1640 920</p>	

<p>Application info CF 65 (01/01--)</p>	<p>CF 75 (01/01--)</p>
--	------------------------

<p>14-34 321 0004 1657 523</p>		<p>Air filter</p>	
		<p>Notes</p> <p>Inner Diameter [mm] 160 Outer Diameter [mm] 267 Height [mm] 480 Filter Insert</p>	
		<p>References</p> <p>1363 024 1657 523 1638 006 1726 060 1640 921 1921 967 1656 513 1933 740</p>	

<p>Application info 65 CF (02/98-12/00) 85 CF (02/98-12/00)</p>	<p>CF 85 (01/01--)</p>
--	------------------------

<p>14-34 321 0001 1664 524</p>		<p>Air filter</p>	
		<p>Notes</p> <p>Inner Diameter [mm] 147 Outer Diameter [mm] 281 Height [mm] 508 Filter Insert</p>	
		<p>References</p> <p>1295 090 1664 524 1353 115 1664 525 1500 399</p>	

<p>Application info 95 XF (01/97-09/02)</p>	
--	--

Air filter
14-34 321 0005
 ACHD040

Notes

Inner Diameter [mm]	106
Outer Diameter [mm]	208
Height [mm]	531
	Filter Insert

References

ACHD040

Application info

55 (11/95-12/00)

Air filter
14-12 321 0008
 ACHH325

Notes

Inner Diameter [mm]	131
Outer Diameter [mm]	214
Height [mm]	371
	Filter Insert

References

ACHH325

Application info

45 (05/91-12/00)

Air filter
14-34 321 0009
 MAK7603

Notes

Inner Diameter [mm]	89
Inner Diameter [mm]	17
Outer Diameter [mm]	154
Height [mm]	290
	Filter Insert

References

MAK7603

Application info

45 (05/91-12/00)



1

034 009 0015
1311 608

Hand primer pump



Notes

Outer Thread [mm] M16x1,5
Manual

References

0194 194 1311 608
194194

Application info

65 CF (02/98-12/00)	F 2500 (02/82-08/91)
75 CF (02/98-12/00)	F 2700 (01/90-10/93)
85 CF (02/98-12/00)	F 2900 (01/90-10/93)
95 (09/87-01/98)	F 3200 (01/90-10/93)
95 XF (01/97-09/02)	F 3300 (06/81-09/91)
F 2100 (07/78-08/91)	F 3600 (06/85-09/91)
F 2300 (07/78-10/93)	

034 009 0013
1604 476

Repair kit, fuel pump



Notes

Kit with seal
Plastic
Inner Diameter [mm] 23.4
Outer Diameter [mm] 50.4
Height [mm] 41.3
with pre-filter

References

1438 836 1683 353
1604 476

Application info

95 XF (01/97-09/02)

12-34 323 0008
1296 851

Fuel filter



Notes

with seal
Outer Diameter [mm] 109
Height [mm] 146
Thread Size 1 1/4"-UNS-2B
Screw-on Filter

References

1296 851



12-34 323 0008
 1296 851

Fuel filter
Application info

 95 XF (01/97-09/02)
 CF 65 (01/01--)

 CF 75 (01/01--)
 CF 85 (01/01--)

Fuel filter
034 009 0003
 1315 514

Notes

Diameter [mm]	36
Height [mm]	52
Port Thread	M20x1,5
	Pre-filter

References

1315 514

Application info

45 (05/91-12/00)	F 2200 (01/71-11/80)
55 (11/95-12/00)	F 2300 (07/78-10/93)
65 (03/93-02/98)	F 2500 (02/82-08/91)
75 (07/92-02/98)	F 2600 (02/72-12/73)
95 (09/87-01/98)	F 2700 (01/90-10/93)
F 1000 (12/86-12/92)	F 2800 (01/74-09/91)
F 1100 (01/78-11/90)	F 2900 (01/90-10/93)
F 1200 (01/69-12/81)	F 3200 (01/90-10/93)
F 1300 (07/78-12/92)	F 3300 (06/81-09/91)
F 1400 (02/72-12/81)	F 3600 (06/85-09/91)
F 1500 (--08/91)	F 500 (12/77-12/79)
F 1600 (01/70-08/91)	F 600 (12/86-12/92)
F 1700 (12/86-02/95)	F 700 (12/75-12/79)
F 1800 (01/70-08/91)	F 800 (12/86-08/91)
F 1900 (12/86-09/93)	F 900 (01/75-11/88)
F 2000 (01/70-12/79)	SB (---)
F 2100 (07/78-08/91)	

Fuel filter
14-34 009 0002
 1318 695

Notes

Outer Diameter [mm]	with seal
Height [mm]	95
Thread Size	144
	M16x1,5
	Screw-on Filter

References

0247 138	0247 139
247138	1318 695
247139	





1

14-34 009 0002
1318 695

Fuel filter

Application info

65 (03/93-02/98)
65 CF (02/98-12/00)
75 (07/92-02/98)
85 (07/92-02/98)
85 CF (02/98-12/00)
95 (09/87-01/98)
95 XF (01/97-09/02)
CF 75 (01/01--)
F 1100 (01/78-11/90)

F 1300 (07/78-12/92)
F 2100 (07/78-08/91)
F 2300 (07/78-10/93)
F 2500 (02/82-08/91)
F 2700 (01/90-10/93)
F 2800 (01/74-09/91)
F 3300 (06/81-09/91)
F 3600 (06/85-09/91)

16-34 323 0009
1318 695

Fuel filter



Notes

Outer Diameter [mm]
Height [mm]
Thread Size

with seal
93
144
M16x1,5
Screw-on Filter

References

1318 695

Application info

LF 45 (01/01--)

14-34 018 0004
1345 335

Fuel filter



Notes

Diameter [mm]
Outer Diameter [mm]
Height [mm]
Thread Size

with seal
62
93
144
M22x1,5
Screw-on Filter

References

1345 335

Application info

75 CF (02/98-12/00)
85 CF (02/98-12/00)

95 XF (01/97-09/02)

14-34 018 0002
 1397 766

Fuel filter
Notes

Diameter 2 [mm]	46
Diameter 1 [mm]	14
Outer Diameter [mm]	105
Height [mm]	202
	Filter Insert

References

1397 766	1784 782
----------	----------

Application info

CF 75 (01/01--)	XF 95 (09/02-12/06)
CF 85 (01/01--)	

14-34 018 0008
 1399 760

Fuel filter
Notes

	with seal
Outer Diameter [mm]	93
Height [mm]	209
Thread Size	M20x1,5
	Screw-on Filter

References

1399 760

Application info

CF 65 (01/01--)	LF 55 (01/01--)
LF 45 (01/01--)	

14-34 018 0016
 1433 649

Fuel filter
Notes

	with seal
Outer Diameter [mm]	108
Height [mm]	231
Thread Size	1-14 UNS -1B
	Screw-on Filter

References

1433 649





1

14-34 018 0016
1433 649

Fuel filter

Application info

95 XF (01/97-09/02)
CF 75 (01/01--)
CF 85 (01/01--)

XF 105 (10/05--)
XF 95 (09/02-12/06)

14-34 018 0009
CBU 1251

Fuel filter



Notes

Outer Diameter [mm]	with seal
Height [mm]	81
Thread Size	154
	M16x1,5
	Screw-on Filter

References

CBU 1251	CBU 1920
----------	----------

Application info

45 (05/91-12/00)
55 (11/95-12/00)

F 600 (12/86-12/92)
F 800 (12/86-08/91)

14-34 234 0012
1372 386

Radiator fan motor

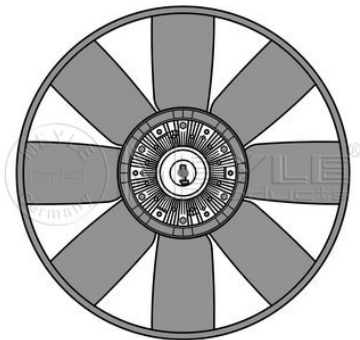

Notes

Number of Wings	8
Outer Diameter [mm]	Thermic
	205

References

1372 386

Application info

CF 75 (01/01--)

Fan clutch
14-34 234 0009
 1224 883

Notes

Number of mounting bores	6
	Thermic
Outer Diameter [mm]	205
Depth [mm]	148

References

1224 883	1306 244
1224 885	1328 797
1306 241	1348 775
1306 242	1349 755

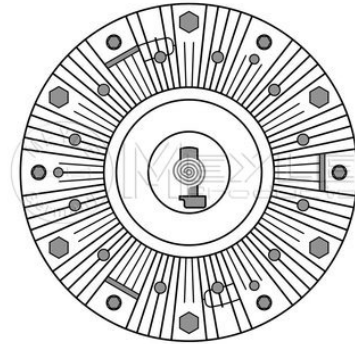
Application info

75 CF (02/98-12/00)

Fan clutch
14-34 234 0008
 1259 622

Notes

Number of mounting bores	4
	Thermic
Outer Diameter [mm]	163
Depth [mm]	141

References

1259 622	1307 823
----------	----------

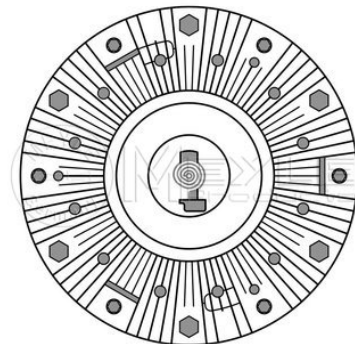
Application info

65 CF (02/98-12/00)

CF 85 (01/01--)

Fan clutch
14-34 234 0011
 1304 249

Notes

Number of mounting bores	6
	Thermic
Outer Diameter [mm]	205
Depth [mm]	131

References

1304 249	1317 003
1305 179	1330 723
1309 649	1363 378
1311 271	

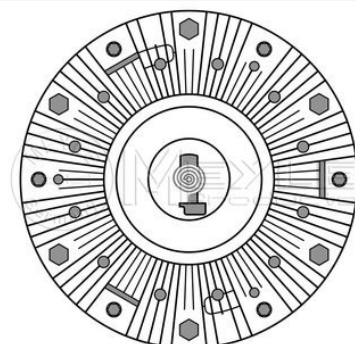
Application info

75 CF (02/98-12/00)

85 CF (02/98-12/00)



1

14-34 234 0007
1306 778

Fan clutch

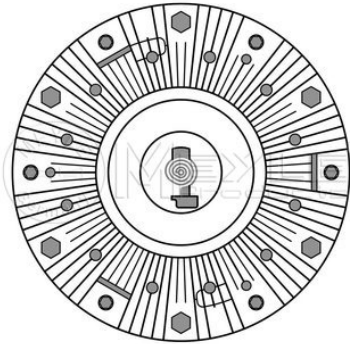

Notes

Number of mounting bores	6
Outer Diameter [mm]	Thermic 249
Depth [mm]	150

References

1306 778	1376 148
----------	----------

Application info

95 (09/87-01/98)

14-34 234 0017
1319 779

Fan clutch

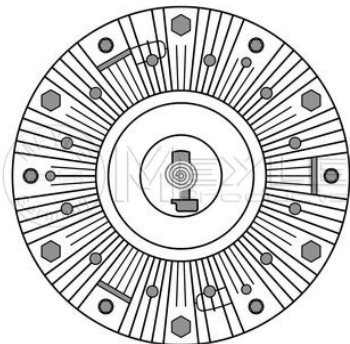

Notes

Number of mounting bores	4
Outer Diameter [mm]	Thermic 223
Depth [mm]	135

References

1319 779	1334 261
1332 181	

Application info

95 XF (01/97-09/02)

14-34 234 0013
1330 224

Fan clutch

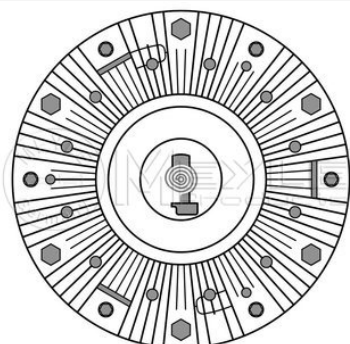

Notes

Number of mounting bores	6
Outer Diameter [mm]	Thermic 205
Depth [mm]	133

References

1330 224	1377 127
1330 724	1377 197

Application info

85 (07/92-02/98)

85 CF (02/98-12/00)

Fan clutch
14-34 234 0006
 1334 259

Notes

Number of mounting bores	6
	Thermic
Outer Diameter [mm]	203
Depth [mm]	148

References

1334 257	1426 402
1334 259	1436 105
1349 834	1436 125
1349 835	

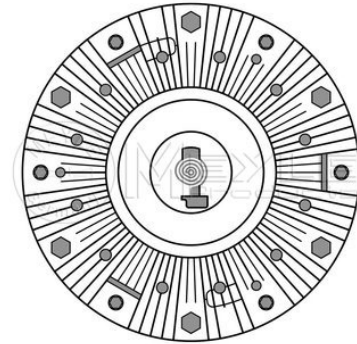
Application info

95 XF (01/97-09/02)

Fan clutch
14-34 234 0016
 1372 387

Notes

Number of mounting bores	6
	Thermic
Outer Diameter [mm]	205
Depth [mm]	136

References

1372 387

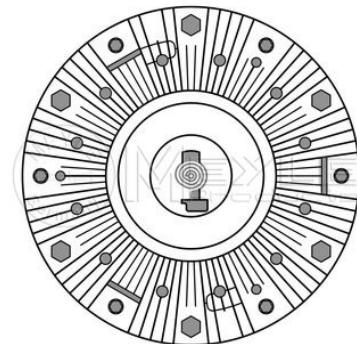
Application info

85 CF (02/98-12/00)

CF 85 (01/01--)

Fan clutch
14-34 234 0015
 1382 108

Notes

Number of mounting bores	6
	Thermic
Outer Diameter [mm]	236
Depth [mm]	142

References

1382 108

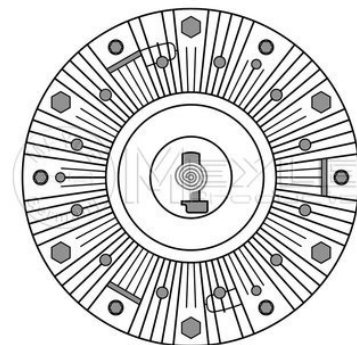
Application info

85 CF (02/98-12/00)



1

14-34 234 0014
1397 382

Fan clutch

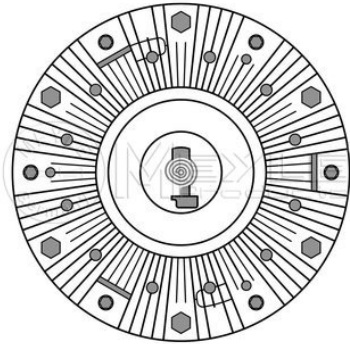

Notes

Number of mounting bores	6
Outer Diameter [mm]	Thermic 205
Depth [mm]	141

References

1397 382

Application info

85 CF (02/98-12/00)

14-34 234 0010
1398 793

Fan clutch

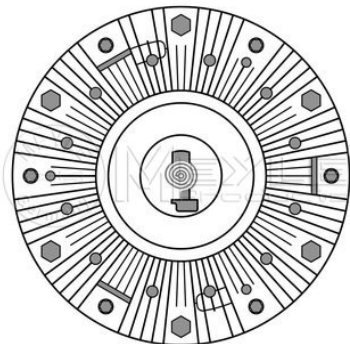

Notes

Number of mounting bores	6
Outer Diameter [mm]	Thermic 205
Depth [mm]	171

References

1398 793

Application info

CF 75 (01/01--)

CF 85 (01/01--)

14-34 234 0018
1402 415

Fan clutch

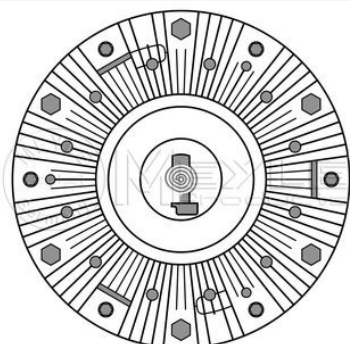

Notes

Number of mounting bores	5
Outer Diameter [mm]	Thermic 205
Depth [mm]	106

References

1402 415	APUB185
1408 555	APUC331

Application info

LF 45 (01/01--)

LF 55 (01/01--)

14-34 234 0004
 1427 573

Fan clutch
Notes

Number of mounting bores	6
	Electric
Outer Diameter [mm]	233
Depth [mm]	154
Number of Poles	5

References

1427 573	1680 935
1666 098	

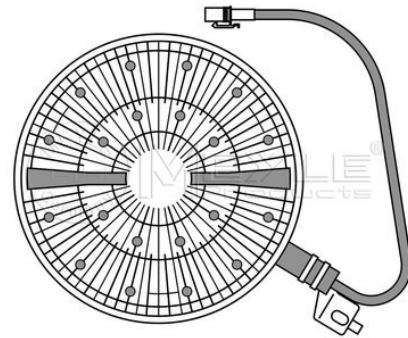
Application info

XF 95 (09/02-12/06)

14-34 234 0005
 1441 774

Fan clutch
Notes

Number of mounting bores	6
	Electric
Outer Diameter [mm]	260
Depth [mm]	150
Number of Poles	5

References

1441 770	1666 156
1441 773	1666 157
1441 774	1680 937
1449 676	1680 938
1449 677	

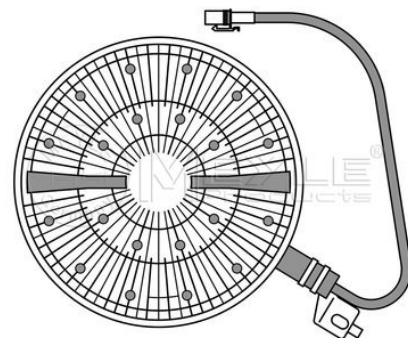
Application info

85 CF (02/98-12/00)

CF 85 (01/01--)

14-34 234 0001
 1449 679

Fan clutch
Notes

Number of mounting bores	6
	Thermic
Outer Diameter [mm]	233
Depth [mm]	171

References

1449 678	1449 679
----------	----------

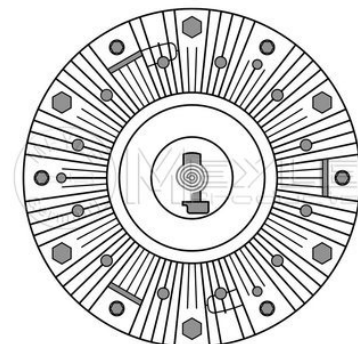
Application info

CF 75 (01/01--)



1

14-34 234 0003
1732 273

Fan clutch

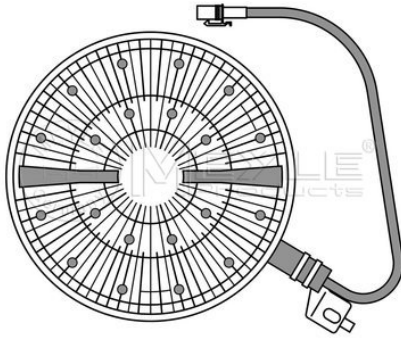

Notes

Number of mounting bores	6
Outer Diameter [mm]	275
Depth [mm]	152
Number of Poles	5

References

1677 080	1732 274
1693 441	1806 712
1697 677	1916 597
1732 273	

Application info

CF 85 (01/01--)

XF 105 (10/05--)

14-34 234 0002
1737 460

Fan clutch

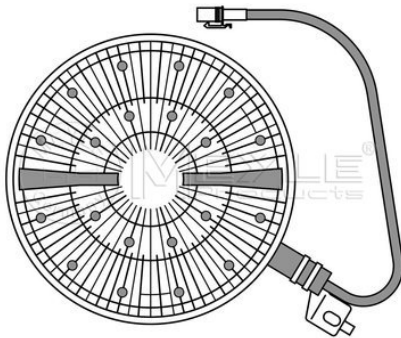

Notes

Number of mounting bores	4
Outer Diameter [mm]	275
Number of Poles	2

References

1737 460	1806 713
1742 083	1916 598

Application info

CF 85 (01/01--)

XF 105 (10/05--)

14-34 232 0003
1224 800

Fan blade

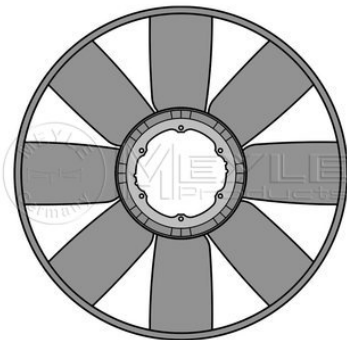

Notes

Number of Wings	8
-----------------	---

References

1224 800

Application info

75 CF (02/98-12/00)

Fan blade
14-34 232 0008
 1236 096

Notes

 Number of Wings 8
 Outer Diameter [mm] 203

References

1236 096

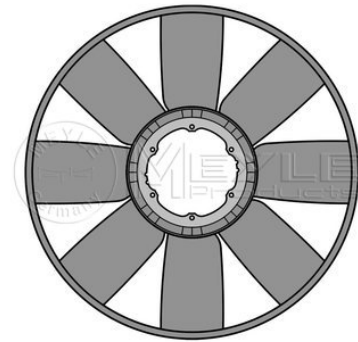
Application info

95 XF (01/97-09/02)

Fan blade
14-34 232 0001
 1263 571

Notes

Number of Wings 10

References

1263 571

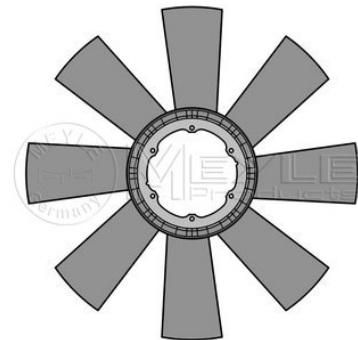
Application info

65 CF (02/98-12/00)

Fan blade
14-34 232 0011
 1282 146

Notes

Number of Wings 10

References

1282 146 1403 238

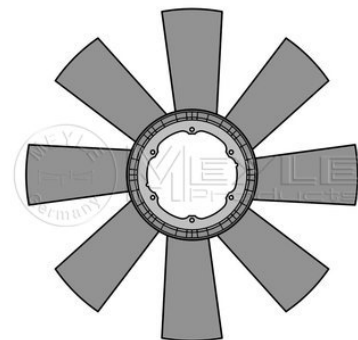
Application info

LF 55 (01/01--)



1

14-34 232 0005
1291 218

Fan blade

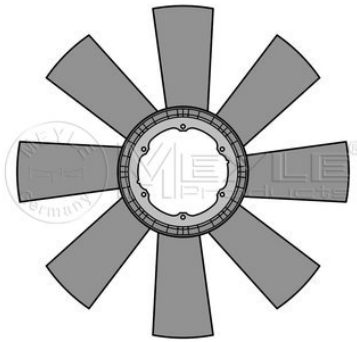

Notes

Number of Wings 8

References

1291 218

Application info

75 CF (02/98-12/00)

CF 75 (01/01--)

14-34 232 0007
1293 812

Fan blade

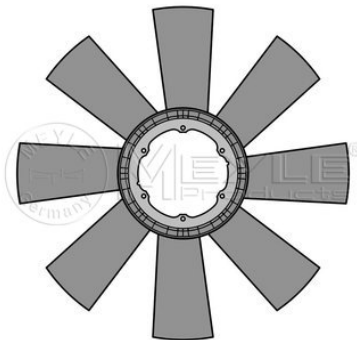

Notes

Number of Wings 8
Outer Diameter [mm] 720

References

1293 812

Application info

95 (09/87-01/98)

95 XF (01/97-09/02)

14-34 232 0004
1300 519

Fan blade

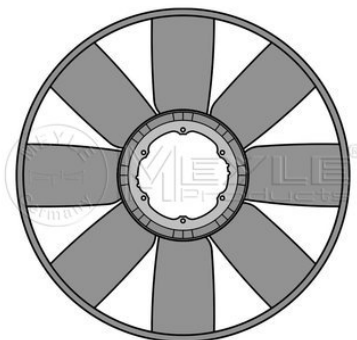

Notes

Number of Wings 8
Outer Diameter [mm] 720

References

1300 519 1315 854

Application info

75 CF (02/98-12/00)

14-34 232 0002
 1308 285

Fan blade
Notes

 Number of Wings 8
 Outer Diameter [mm] 704

References

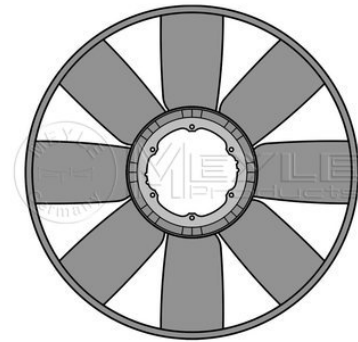
 1308 285 1448 197
 1399 180 1733 234

Application info

 65 CF (02/98-12/00) CF 75 (01/01--)
 75 CF (02/98-12/00) CF 85 (01/01--)
 85 CF (02/98-12/00)

Fan blade
14-34 232 0009
 1338 736

Notes

 Number of Wings 8
 Outer Diameter [mm] 720

References

1338 736

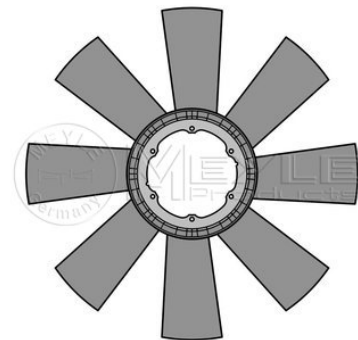
Application info

95 XF (01/97-09/02) XF 95 (09/02-12/06)

Fan blade
14-34 232 0006
 1376 260

Notes

 Number of Wings 8
 Outer Diameter [mm] 725

References

1376 260

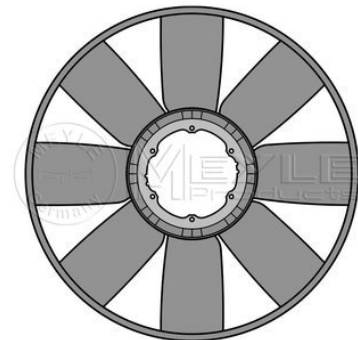
Application info

CF 75 (01/01--)



1

14-34 232 0012
1399 819

Fan blade

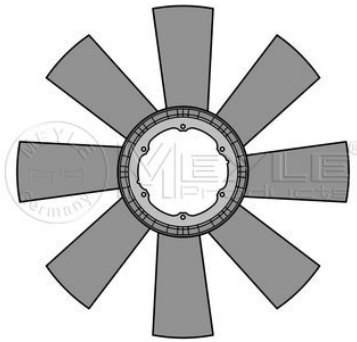

Notes

Number of Wings	7
Outer Diameter [mm]	720

References

1399 819

Application info

XF 105 (10/05--)

XF 95 (09/02-12/06)

14-34 232 0010
1402 417

Fan blade

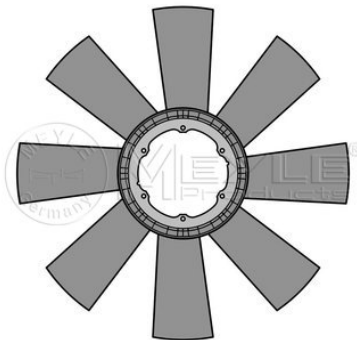

References

1402 417	1403 248
----------	----------

Application info

LF 45 (01/01--)

LF 55 (01/01--)

14-33 220 0003
0683 579

Water pump



Notes

with seal

References

0683 579	1609 853
683 579	0683 579 R
1399 150	683 579 R

Application info

85 CF (02/98-12/00)
95 XF (01/97-09/02)

CF 85 (01/01--)

14-33 220 0001
 1609 871

Water pump
Notes

Weight [kg]

 for v-ribbed belt use
 11.1
 with seal
 1-part housing
 Metal impeller
 without belt pulley

References

 0683 225
 683225
 683586

 0683 586
 1609 871

Application info

 75 CF (02/98-12/00)
 85 CF (02/98-12/00)

 95 XF (01/97-09/02)
 LF 45 (01/01--)

14-33 220 0002
 1778 280

Water pump
Notes

 with seal
 1-part housing
 with v-ribbed belt pulley
 with seal

References

 1664 762
 1738 991

 1778 280
 1828 162

Application info

 CF 85 (01/01--)
 XF 105 (10/05--)

XF 95 (09/02-12/06)

14-28 282 0001
 1684 900

Thermostat
Notes

Opening Temperature [°C]

 with seal
 82

References

 1303 061
 1439 844

1684 900





14-28 282 0001
1684 900

Thermostat

Application info

75 CF (02/98-12/00)
85 CF (02/98-12/00)

CF 75 (01/01--)
CF 85 (01/01--)

14-34 223 0001
1607 794

Expansion tank



Notes

Opening Pressure [bar]

Width [mm]
Depth [mm]
Length [mm]
Capacity [Litre]

Black
without add-on material
1
PP (Polypropylene)
337
104
547
11.8
without valves
without filler cap
Front

References

1295 910

1607 794

Parts list

14-34 223 0003
14-34 238 0002
14-34 238 0003

Sensor, coolant level
Expansion tank cap
Expansion tank cap

Application info

95 XF (01/97-09/02)

XF 95 (09/02-12/06)

14-34 223 0005
1626 237

Expansion tank



Notes

Opening Pressure [bar]

Width [mm]
Depth [mm]
Length [mm]
Capacity [Litre]

Black
without add-on material
1
PP (Polypropylene)
345
105
555
6.7
without filler cap
Front

References

1626 237

Parts list

14-34 238 0002
14-34 238 0003

Expansion tank cap
Expansion tank cap

14-34 223 0005
 1626 237

Expansion tank
Application info

XF 105 (10/05--)

14-34 223 0006
 1684 655

Expansion tank
Notes

	Black without add-on material
Opening Pressure [bar]	1
	PP (Polypropylene)
Width [mm]	337
Depth [mm]	104
Length [mm]	547
Capacity [Litre]	11.8 without filler cap Front

References

1684 655

Parts list

14-34 238 0002	Expansion tank cap
14-34 238 0003	Expansion tank cap

Application info

XF 95 (09/02-12/06)

16-34 223 0001
 1700 772

Expansion tank
Notes

	Transparent
Opening Pressure [bar]	0.7
	PP (Polypropylene)
Pressure [bar]	0.7
Width [mm]	380
Depth [mm]	146
Length [mm]	619
Capacity [Litre]	11 with sensor with filler cap Front

References

1700 772 1702 252

Parts list

039 238 0001	Expansion tank cap
--------------	--------------------

Application info

LF 45 (01/01--)

LF 55 (01/01--)



1

14-34 223 0004
1871 493

Expansion tank



Notes

	Black/White without add-on material
Opening Pressure [bar]	1.2
Width [mm]	PP (Polypropylene)
Depth [mm]	382
Length [mm]	293
	594 with filler cap
	Front

References

1371 329	1871 493
1660 859	

Parts list

14-34 899 0001	Sensor, coolant level
14-34 238 0001	Expansion tank cap

Application info

75 CF (02/98-12/00)	CF 65 (01/01--)
85 (07/92-02/98)	CF 75 (01/01--)
85 CF (02/98-12/00)	CF 85 (01/01--)

14-34 899 0001
1740 758

Sensor, coolant level



Notes

	Active sensor
Operating voltage [V]	24
Fitting Depth [mm]	290
Length [mm]	325
Number of Poles	2

References

1371 332	1740 758
1624 783	

Application info

75 CF (02/98-12/00)	CF 75 (01/01--)
85 CF (02/98-12/00)	CF 85 (01/01--)

14-34 238 0003
 1399 820

Expansion tank cap
Notes

Black
 Round
 1

Pressure [bar]

References

1399 820

Application info

 95 XF (01/97-09/02)
 CF 85 (01/01--)

 XF 105 (10/05--)
 XF 95 (09/02-12/06)

14-34 238 0002
 1685 352

Expansion tank cap
Notes

Black
 Round
 81

Diameter [mm]

References

1685 352

Application info

 85 CF (02/98-12/00)
 95 XF (01/97-09/02)

 XF 105 (10/05--)
 XF 95 (09/02-12/06)

14-34 238 0001
 1743 703

Expansion tank cap
Notes

Black
 Round
 1.45
 67

 Pressure [bar]
 Diameter [mm]

References

1371 331 1743 703
 1615 509 1867 861
 1657 336





1

14-34 238 0001
1743 703

Expansion tank cap

Application info

65 (03/93-02/98)
75 CF (02/98-12/00)
85 CF (02/98-12/00)

CF 75 (01/01--)
CF 85 (01/01--)

14-34 000 0002
1406 486

Belt tensioner

Notes

Outer Diameter [mm] 85
Width [mm] 32

References

1406 486 1702 525

Application info

CF 65 (01/01--)
LF 45 (01/01--)

LF 55 (01/01--)

14-34 000 0003
1627 625

Belt tensioner



References

1627 625 1695 242
1694 953

Application info

CF 85 (01/01--)

XF 105 (10/05--)

Belt tensioner

14-34 000 0001
 1628 148

Notes

 Belt Pulley Ø [mm] 77
 Height [mm] 103

References

 1398 620 1614 978
 1458 764 1628 148

Application info

 95 XF (01/97-09/02) XF 95 (09/02-12/06)
 CF 85 (01/01--)

Tension roller, ribbed belt

14-34 000 0004
 1811 819

Notes

 Outer Diameter [mm] 78
 Width [mm] 38

References

 1638 696 1699 240
 1687 821 1811 819

Application info

CF 85 (01/01--) XF 105 (10/05--)

V-belt

052 013 1600
 0067 681

Notes

 Width [mm] 13
 Length [mm] 1600

References

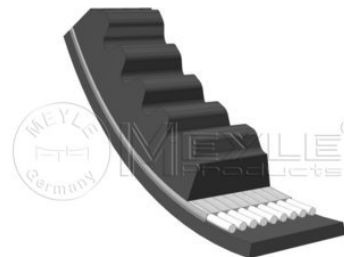
 0067 681 67681
 067681

Application info

F 2300 (07/78-10/93) F 2500 (02/82-08/91)

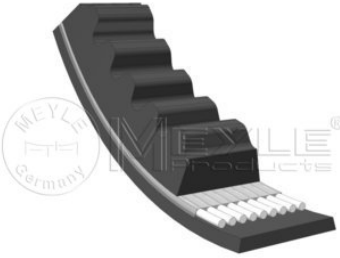
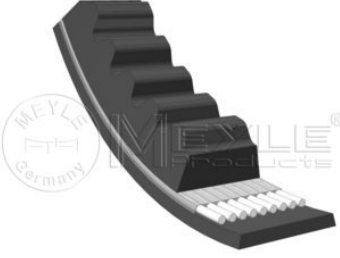
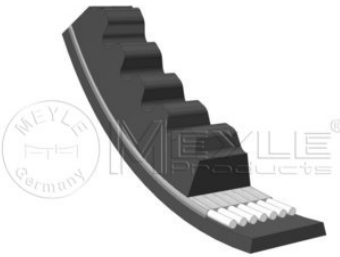

1

<p>052 013 1050 0296 961</p>		<p>V-belt</p>									
		<p>Notes</p> <table border="0"> <tr> <td>Width [mm]</td> <td>13</td> </tr> <tr> <td>Length [mm]</td> <td>1050</td> </tr> </table> <p>References</p> <table border="0"> <tr> <td>0296 961</td> <td>296961</td> </tr> </table>		Width [mm]	13	Length [mm]	1050	0296 961	296961		
Width [mm]	13										
Length [mm]	1050										
0296 961	296961										
<p>Application info F 2500 (02/82-08/91)</p>											
<p>052 013 1475 0655 043</p>		<p>V-belt</p>									
		<p>Notes</p> <table border="0"> <tr> <td>Width [mm]</td> <td>13</td> </tr> <tr> <td>Length [mm]</td> <td>1475</td> </tr> </table> <p>References</p> <table border="0"> <tr> <td>0238 770</td> <td>655043</td> </tr> <tr> <td>238770</td> <td>0655 043</td> </tr> </table>		Width [mm]	13	Length [mm]	1475	0238 770	655043	238770	0655 043
Width [mm]	13										
Length [mm]	1475										
0238 770	655043										
238770	0655 043										
<p>Application info 65 (03/93-02/98) CF 65 (01/01--)</p>		<p>F 2100 (07/78-08/91)</p>									
<p>052 010 0975 0679 733</p>		<p>V-belt</p>									
		<p>Notes</p> <table border="0"> <tr> <td>Width [mm]</td> <td>10</td> </tr> <tr> <td>Length [mm]</td> <td>975</td> </tr> </table> <p>References</p> <table border="0"> <tr> <td>0679 733</td> <td>679733</td> </tr> </table>		Width [mm]	10	Length [mm]	975	0679 733	679733		
Width [mm]	10										
Length [mm]	975										
0679 733	679733										
<p>Application info F 2300 (07/78-10/93) F 2500 (02/82-08/91)</p>		<p>F 2700 (01/90-10/93)</p>									

052 013 1525
 1265 398

V-belt
Notes

 Width [mm] 13
 Length [mm] 1525

References

248761 1265 398

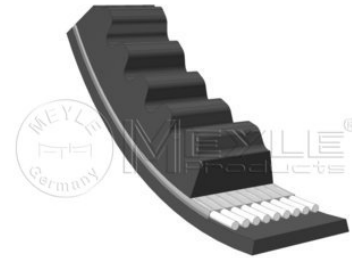
Application info

F 1600 (01/70-08/91)

052 013 1000
 1425 709

V-belt
Notes

 Width [mm] 13
 Length [mm] 1000

References

1425 709

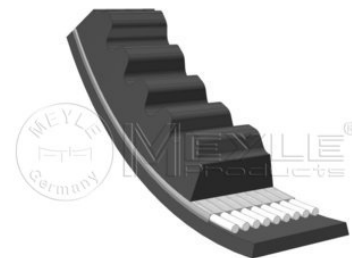
Application info

 85 CF (02/98-12/00)
 95 XF (01/97-09/02)

CF 85 (01/01--)

050 008 1398
 0067 690

V-ribbed belt
Notes

 Width [mm] 28
 Number of Ribs 8
 Length [mm] 1398
 EPDM (ethylene propylene diene Monomer (M-class) rubber)
 One-sided

References

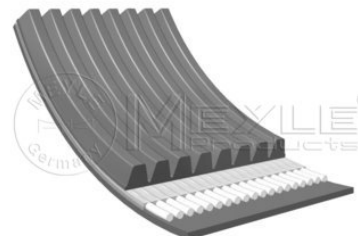
 0067 690 0490 269
 067690 CBU1182
 67690 CBU1532
 490269



1

050 008 1398
0067 690

V-ribbed belt

Application info

45 (05/91-12/00)
F 1000 (12/86-12/92)

F 600 (12/86-12/92)
F 800 (12/86-08/91)

050 008 1915
1372 669

V-ribbed belt

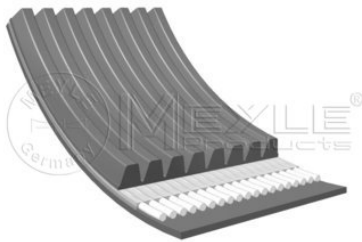

Notes

Width [mm]
Number of Ribs
Length [mm]

EPDM (ethylene propylene diene
Monomer (M-class) rubber)
28
8
1915
One-sided

References

1152 425

1372 669

Application info

XF 105 (10/05--)

XF 95 (09/02-12/06)

050 008 1525
1388 161

V-ribbed belt

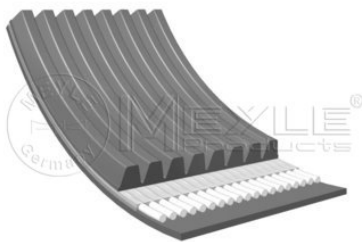

Notes

Width [mm]
Number of Ribs
Length [mm]

EPDM (ethylene propylene diene
Monomer (M-class) rubber)
28
8
1525
One-sided

References

1388 161

1702 605

Application info

CF 65 (01/01--)
LF 45 (01/01--)

LF 55 (01/01--)

050 008 2050
 1393 280

V-ribbed belt
Notes

EPDM (ethylene propylene diene Monomer (M-class) rubber)

Width [mm] 28
 Number of Ribs 8
 Length [mm] 2050
 One-sided

References

1393 280

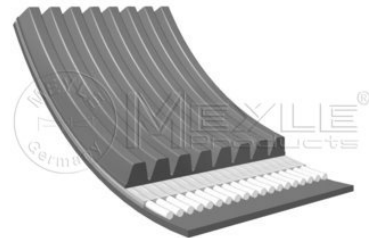
Application info

CF 85 (01/01--)

050 008 1215
 1393 344

V-ribbed belt
Notes

EPDM (ethylene propylene diene Monomer (M-class) rubber)

Width [mm] 28
 Number of Ribs 8
 Length [mm] 1215
 One-sided

References

1393 344

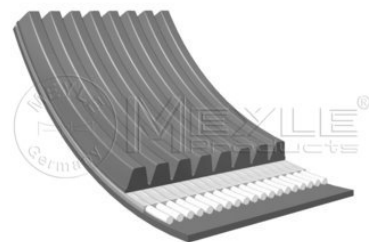
Application info

 CF 65 (01/01--)
 LF 45 (01/01--)

LF 55 (01/01--)

050 008 1720
 1393 365

V-ribbed belt
Notes

EPDM (ethylene propylene diene Monomer (M-class) rubber)

Width [mm] 28
 Number of Ribs 8
 Length [mm] 1720
 One-sided

References

1393 365

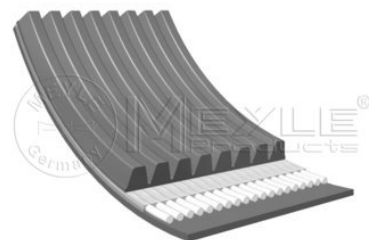
Application info

CF 85 (01/01--)



1

050 008 2380
1398 637

V-ribbed belt

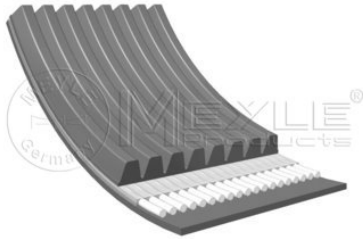

Notes

Width [mm]
Number of Ribs
Length [mm]

EPDM (ethylene propylene diene
Monomer (M-class) rubber)
28
8
2380
One-sided

References

1398 637

Application info

75 CF (02/98-12/00)

CF 75 (01/01--)

050 008 2120
1444 203

V-ribbed belt

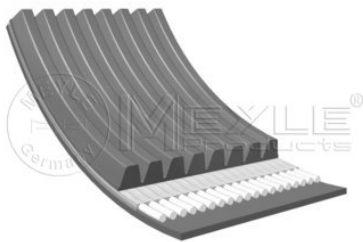

Notes

Width [mm]
Number of Ribs
Length [mm]

EPDM (ethylene propylene diene
Monomer (M-class) rubber)
28
8
2120
One-sided

References

1444 203

Application info

85 CF (02/98-12/00)

050 007 1750
1638 698

V-ribbed belt

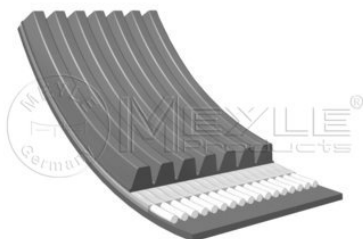

Notes

Width [mm]
Number of Ribs
Length [mm]

EPDM (ethylene propylene diene
Monomer (M-class) rubber)
24
7
1750
One-sided

References

1638 698

1812 162

Application info

CF 85 (01/01--)

050 009 1380
 1661 948

V-ribbed belt
Notes

EPDM (ethylene propylene diene
 Monomer (M-class) rubber)

Width [mm] 32
 Number of Ribs 9
 Length [mm] 1380
 One-sided

References

1654 398 1661 948

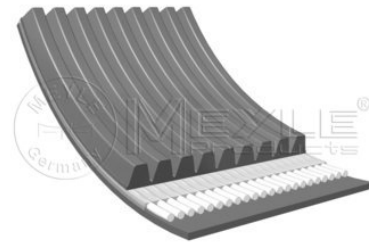
Application info

CF 85 (01/01--)

050 009 1424
 1661 949

V-ribbed belt
Notes

EPDM (ethylene propylene diene
 Monomer (M-class) rubber)

Width [mm] 32
 Number of Ribs 9
 Length [mm] 1424
 One-sided

References

1661 949 1661 954

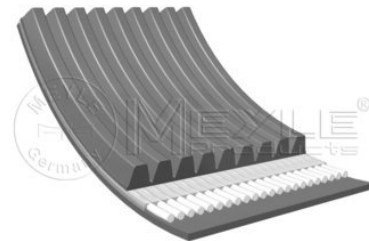
Application info

CF 85 (01/01--)

050 008 1460
 CBU 1716

V-ribbed belt
Notes

EPDM (ethylene propylene diene
 Monomer (M-class) rubber)

Width [mm] 28
 Number of Ribs 8
 Length [mm] 1460
 One-sided

References

CBU 1716

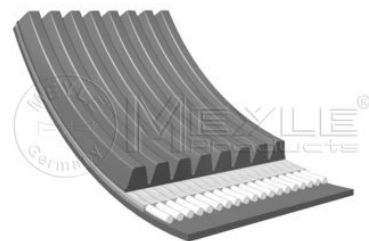
Application info

45 (05/91-12/00)

55 (11/95-12/00)



2

12-34 042 0010
1198 153

Repair kit, brake caliper



Notes

Front Axle

References

1142 142	1198 154
1198 153	1448 915

Application info

65 CF (02/98-12/00)
75 CF (02/98-12/00)
85 CF (02/98-12/00)
95 XF (01/97-09/02)

CF 65 (01/01--)
CF 75 (01/01--)
CF 85 (01/01--)
LF 55 (01/01--)

14-35 521 0003
1387 439

Brake disc



Notes

Internally Vented

Centering Diameter [mm] 258
Minimum Thickness [mm] 41
Outer Diameter [mm] 432
Height [mm] 45
Bolt Hole Circle Ø [mm] 240
Brake Disc Thickness [mm] 45
Number of Holes 10

Rear Axle
Front Axle

References

1387 439	1783 346
1640 561	1812 563
1726 138	1812 582

Application info

85 CF (02/98-12/00)
95 XF (01/97-09/02)
CF 65 (01/01--)
CF 75 (01/01--)
CF 85 (01/01--)

LF 45 (01/01--)
LF 55 (01/01--)
XF 105 (10/05--)
XF 95 (09/02-12/06)

14-35 521 0006
 1408 253

Brake disc
Notes

Wheel Bolt Bore Ø [mm]	16
Centering Diameter [mm]	143
Outer Diameter [mm]	330
Height [mm]	143.5
Bolt Hole Circle Ø [mm]	155
Brake System	WABCO PAN 17
Brake Disc Thickness [mm]	34
Number of Holes	16
	Front Axle

References

1403 758	1408 671
1408 253	

Application info

LF 45 (01/01--)

14-35 521 0004
 AMPA014

Brake disc
Notes

	Internally Vented
Centering Diameter [mm]	155
Minimum Thickness [mm]	40
Outer Diameter [mm]	375
Height [mm]	128
Brake System	WABCO 1600-V-G
Brake Disc Thickness [mm]	44
Number of Holes	10
	Front Axle

References

AMPA014	AMPB860
AMPB481	NJK2785

Application info

55 (11/95-12/00)



2

14-35 521 0005
AMPB887 **Brake disc**

Notes	
Centering Diameter [mm]	Internally Vented 133
Minimum Thickness [mm]	27
Outer Diameter [mm]	312
Height [mm]	134
Bolt Hole Circle Ø [mm]	155
Brake Disc Thickness [mm]	30
Number of Holes	12 Front Axle
References	
AMPB887	PAK3546
MAK2578	PAK5513

Application info	
45 (05/91-12/00) F 600 (12/86-12/92)	F 800 (12/86-08/91)

025 290 8730
1439 324 **Brake pad set**

	Notes
	without accessories prepared for wear indicator
Thickness [mm]	30
Height [mm]	109.5
Width [mm]	247.3
Brake System	Knorr Rear Axle Front Axle
References	
1439 324	1797 053
1617 343	1878 030

Application info	
CF 65 (01/01--) CF 75 (01/01--)	CF 85 (01/01--) XF 95 (09/02-12/06)

025 290 8730/S
 1439 324

Brake pad set
Notes

with accessories
 prepared for wear indicator

Thickness [mm] 30
 Height [mm] 109.5
 Width [mm] 247.3
 Brake System Knorr
 Rear Axle
 Front Axle

References

1439 324

Application info

 CF 65 (01/01--)
 CF 75 (01/01--)

 CF 85 (01/01--)
 XF 95 (09/02-12/06)

025 290 2423
 BBU8177

Brake pad set
Notes

without add-on material
 with integrated wear sensor

Thickness [mm] 23
 Height [mm] 87
 Width [mm] 191
 Brake System Wabco 456 F-I
 Front Axle

References

BBU8177

Application info

45 (05/91-12/00)



2

14-34 533 0004
1315 691

ABS wheel sensor



Notes

Cable Length [mm]
Operating voltage [V]
Length [mm]
Number of Poles
Required quantity
Resistance [Ohm]

with accessories
Inductive Sensor
for vehicles with ABS
220
24
300
2
2
1150
Rear Axle
Front Axle

References

1230 594	1361 393
1238 561	1778 553
1315 691	1778 554

Application info

65 (03/93-02/98)	95 (09/87-01/98)
65 CF (02/98-12/00)	95 XF (01/97-09/02)
75 (07/92-02/98)	CF 65 (01/01--)
75 CF (02/98-12/00)	CF 75 (01/01--)
85 (07/92-02/98)	CF 85 (01/01--)
85 CF (02/98-12/00)	

034 533 0017
1315 698

ABS wheel sensor



Notes

Cable Length [mm]
Operating voltage [V]
Length [mm]
Number of Poles
Required quantity
Resistance [Ohm]

with accessories
Inductive Sensor
for vehicles with ABS
325
24
400
2
2
1150
Rear Axle left and right

References

1315 698	1504 951
----------	----------

Application info

65 CF (02/98-12/00)	95 (09/87-01/98)
75 (07/92-02/98)	95 XF (01/97-09/02)
75 CF (02/98-12/00)	CF 65 (01/01--)
85 (07/92-02/98)	CF 75 (01/01--)
85 CF (02/98-12/00)	CF 85 (01/01--)

ABS wheel sensor
534 003 0001
 1400 071

Notes

	with accessories
	Passive sensor
	for vehicles with ABS
Cable Length [mm]	1700
Operating voltage [V]	24
Length [mm]	1840
Number of Poles	2
Required quantity	2
Resistance [Ohm]	1150
	Rear Axle
	Front Axle

References

1400 071	1525 416
1506 149	

Application info

LF 45 (01/01--)

LF 55 (01/01--)

ABS wheel sensor
14-34 533 0017
 1504 930

Notes

	with accessories
	Active sensor
Cable Length [mm]	925
Operating voltage [V]	24
Number of Poles	2
Required quantity	2
	Front Axle

References

1504 930	1505 215
----------	----------

Application info

85 CF (02/98-12/00)



2

14-34 533 0010
1505 212

ABS wheel sensor



Notes

Cable Length [mm]
Operating voltage [V]
Length [mm]
Number of Poles
Required quantity
Resistance [Ohm]

with accessories
Passive sensor
for vehicles with ABS
2050
24
2080
2
2
1150
Rear Axle
Front Axle

References

1505 212

Application info

CF 65 (01/01--)
CF 75 (01/01--)

CF 85 (01/01--)

14-34 533 0001
1506 003

ABS wheel sensor



Notes

Cable Length [mm]
Operating voltage [V]
Length [mm]
Number of Poles
Required quantity
Resistance [Ohm]

with accessories
Inductive Sensor
for vehicles with ABS
990
24
1070
2
2
1150
Front Axle

References

1506 003

Application info

95 XF (01/97-09/02)

034 533 0031
 1518 002

ABS wheel sensor
Notes

	with accessories
	Inductive Sensor
	for vehicles with ABS
Cable Length [mm]	2850
Operating voltage [V]	24
Length [mm]	2900
Number of Poles	2
Required quantity	1
Resistance [Ohm]	1150
	Rear Axle
	Front Axle

References

1518 002

Counterpart

034 533 0032

Application info

75 CF (02/98-12/00)

034 533 0032
 1518 003

ABS wheel sensor
Notes

	with accessories
	Inductive Sensor
	for vehicles with ABS
Cable Length [mm]	2860
Operating voltage [V]	24
Length [mm]	2900
Number of Poles	2
Required quantity	1
Resistance [Ohm]	1150
	Rear Axle
	Front Axle

References

1518 003

Counterpart

034 533 0031

Application info

75 CF (02/98-12/00)



2

<p>14-34 533 0018 1518 010</p>	<p>ABS wheel sensor</p>												
	<p>Notes</p> <table border="0"> <tr> <td>Operating voltage [V]</td> <td>Active sensor</td> </tr> <tr> <td>Length [mm]</td> <td>24</td> </tr> <tr> <td>Number of Poles</td> <td>3555</td> </tr> <tr> <td>Required quantity</td> <td>2</td> </tr> <tr> <td></td> <td>2</td> </tr> <tr> <td></td> <td>Rear Axle</td> </tr> </table> <p>References 1518 010</p>	Operating voltage [V]	Active sensor	Length [mm]	24	Number of Poles	3555	Required quantity	2		2		Rear Axle
Operating voltage [V]	Active sensor												
Length [mm]	24												
Number of Poles	3555												
Required quantity	2												
	2												
	Rear Axle												

<p>Application info CF 65 (01/01--)</p>
--

<p>034 533 0035 1518 311</p>	<p>ABS wheel sensor</p>																						
	<p>Notes</p> <table border="0"> <tr> <td></td> <td>with accessories</td> </tr> <tr> <td></td> <td>Inductive Sensor</td> </tr> <tr> <td></td> <td>for vehicles with ABS</td> </tr> <tr> <td>Cable Length [mm]</td> <td>2150</td> </tr> <tr> <td>Operating voltage [V]</td> <td>24</td> </tr> <tr> <td>Length [mm]</td> <td>2200</td> </tr> <tr> <td>Number of Poles</td> <td>2</td> </tr> <tr> <td>Required quantity</td> <td>2</td> </tr> <tr> <td>Resistance [Ohm]</td> <td>1150</td> </tr> <tr> <td></td> <td>Rear Axle</td> </tr> <tr> <td></td> <td>Front Axle</td> </tr> </table> <p>References 1518 311</p>		with accessories		Inductive Sensor		for vehicles with ABS	Cable Length [mm]	2150	Operating voltage [V]	24	Length [mm]	2200	Number of Poles	2	Required quantity	2	Resistance [Ohm]	1150		Rear Axle		Front Axle
	with accessories																						
	Inductive Sensor																						
	for vehicles with ABS																						
Cable Length [mm]	2150																						
Operating voltage [V]	24																						
Length [mm]	2200																						
Number of Poles	2																						
Required quantity	2																						
Resistance [Ohm]	1150																						
	Rear Axle																						
	Front Axle																						

<p>Application info 75 CF (02/98-12/00)</p>
--

<p>14-34 533 0011 TP01020001</p>	<p>ABS wheel sensor</p>																		
	<p>Notes</p> <table border="0"> <tr> <td></td> <td>with accessories</td> </tr> <tr> <td></td> <td>Inductive Sensor</td> </tr> <tr> <td></td> <td>for vehicles with ABS</td> </tr> <tr> <td>Operating voltage [V]</td> <td>24</td> </tr> <tr> <td>Number of Poles</td> <td>2</td> </tr> <tr> <td>Required quantity</td> <td>2</td> </tr> <tr> <td>Resistance [Ohm]</td> <td>1750</td> </tr> <tr> <td></td> <td>Rear Axle</td> </tr> <tr> <td></td> <td>Front Axle</td> </tr> </table> <p>References TP01020001</p>		with accessories		Inductive Sensor		for vehicles with ABS	Operating voltage [V]	24	Number of Poles	2	Required quantity	2	Resistance [Ohm]	1750		Rear Axle		Front Axle
	with accessories																		
	Inductive Sensor																		
	for vehicles with ABS																		
Operating voltage [V]	24																		
Number of Poles	2																		
Required quantity	2																		
Resistance [Ohm]	1750																		
	Rear Axle																		
	Front Axle																		



ABS wheel sensor
14-34 533 0011
 TP01020001

Application info

95 XF (01/97-09/02)

Connecting Cable, ABS
14-34 533 0002
 0867 636

References

0867 636

867636

Application info

75 CF (02/98-12/00)

85 (07/92-02/98)

85 CF (02/98-12/00)

95 (09/87-01/98)

95 XF (01/97-09/02)

CF 65 (01/01--)

CF 75 (01/01--)

CF 85 (01/01--)

XF 105 (10/05--)

XF 95 (09/02-12/06)

Cylinder head, compressor
034 013 0006
 1517 929

References

1517 929

BBU5510

Application info

F 1900 (12/86-09/93)



2

14-34 042 0005
1391 510

Air dryer cartridge



Notes

Inner Thread [mm]	M41x1,5
Outer Diameter [mm]	141
Height [mm]	135

References

1391 510

Application info

CF 65 (01/01--)
CF 75 (01/01--)

CF 85 (01/01--)

12-34 032 0000
1600 469

Air suspension valve



Notes

Left and right

References

0759 050	1445 900
759050	1600 469
1341 990	

Application info

75 CF (02/98-12/00)
85 CF (02/98-12/00)
95 (09/87-01/98)
95 XF (01/97-09/02)
CF 65 (01/01--)

CF 75 (01/01--)
CF 85 (01/01--)
F 1600 (01/70-08/91)
F 1800 (01/70-08/91)

834 533 0004
1305 844

Sensor, pneumatic suspension level



References

1305 844	1505 287
----------	----------

+

Sensor, pneumatic suspension level
834 533 0004
 1305 844

Application info

65 CF (02/98-12/00)	F 2100 (07/78-08/91)
75 CF (02/98-12/00)	F 2300 (07/78-10/93)
85 CF (02/98-12/00)	F 2500 (02/82-08/91)
95 XF (01/97-09/02)	LF 45 (01/01--)
CF 75 (01/01--)	LF 55 (01/01--)
CF 85 (01/01--)	

Sensor, pneumatic suspension level
16-34 032 0003
 1365 935

References

1365 935

Application info

65 (03/93-02/98)	85 (07/92-02/98)
75 (07/92-02/98)	

Brake line coupling
034 042 0034
 0109 916

Notes

	Yellow
Number of ports	1
Port Thread	M22x1,5
Operating Pressure [bar]	8

References

0109 916	109916
----------	--------

Counterpart

034 042 0033

Application info

CF 75 (01/01--)



2

034 042 0033
1427 369

Brake line coupling



Notes

Number of ports	Red
Port Thread	1
Operating Pressure [bar]	M22x1,5
	8.2

References

1427 369

Counterpart

034 042 0034

Application info

75 (07/92-02/98)

034 042 0038
1504 961

Brake line coupling



Notes

Number of ports	Red
Port Thread	1
Operating Pressure [bar]	M16x1,5
	8.1

References

1504 961

Counterpart

034 042 0039

Application info

75 (07/92-02/98)

F 1100 (01/78-11/90)

034 042 0039
1519 232

Brake line coupling



Notes

Number of ports	Yellow
Port Thread	1
Operating Pressure [bar]	M16x1,5
	8.1

References

1519 232

Counterpart

034 042 0038

Application info

75 (07/92-02/98)

F 1100 (01/78-11/90)

Line filter, compressor system
034 042 0024
 0587 805

Notes

Pressure [bar] 8

References

0587 805 587805

Application info

 F 2300 (07/78-10/93) LF 55 (01/01--)
 LF 45 (01/01--)

Slave cylinder
034 043 0005
 1505 023

Notes

 Diameter [mm] 35
 Thread Size M18x1
 Black

References

1505 023

Application info

75 CF (02/98-12/00) 85 CF (02/98-12/00)

Check valve
034 042 0051
 0307 475

Notes

Non-return Valve

References

 0288 495 0507 808
 288495 507808
 307475 587808
 0307 475 0587 808

Application info

F 2300 (07/78-10/93) F 2500 (02/82-08/91)



2

034 043 0039
0167 846

Control valve, trailer



Notes

Thread Size M16x1,5
Operating Pressure [bar] 10

References

0167 846 167846

Application info

F 2100 (07/78-08/91)

F 2300 (07/78-10/93)

034 042 0001
0501 182

Diaphragm, brake cylinder



Notes

Equipment Variant T24
Rubber with textile reinforcement
Diameter [in] 24"

References

0501 182 0706 123
501182 FBU8648
706123

Application info

45 (05/91-12/00)

55 (11/95-12/00)

034 042 0062
0689 366

Diaphragm, brake cylinder



Notes

Equipment Variant T20L
Rubber with textile reinforcement
Diameter [in] 20"

References

0689 366 689366

Application info

55 (11/95-12/00)

Diaphragm, brake cylinder
034 042 0061
 0689 511

Notes

Equipment Variant T16L
 Rubber with textile reinforcement
 Diameter [in] 16"

References

0689 511 FBU9614
 689511

Application info

75 (07/92-02/98)

Diaphragm, brake cylinder
034 042 0002
 0691 602

Notes

Equipment Variant T30L
 Rubber with textile reinforcement
 Diameter [in] 30"

References

0691 602 694277
 691602 0694 277

Application info

F 1000 (12/86-12/92)

Diaphragm, brake cylinder
034 042 0043
 0695 751

Notes

Equipment Variant T24L
 Rubber with textile reinforcement
 Diameter [in] 24"

References

0695 751 695751

Application info

F 2200 (01/71-11/80)



2

034 042 0003
0706 128

Diaphragm, brake cylinder



Notes

Equipment Variant	T30
Diameter [in]	Rubber with textile reinforcement 30"

References

0305 049	0533 891
305049	0706 128
533891	706128

Application info

F 1800 (01/70-08/91)

034 043 0002
1325 345

Diaphragm, brake cylinder



Notes

Equipment Variant	T20
Diameter [in]	Rubber with textile reinforcement 20"

References

0303 055	1325 345
303055	

Application info

65 (03/93-02/98)

034 026 0027
0692 183

Valve, compressor system



Notes

Relay Valve

References

0069 237	692183
069237	0692 183
69237	



Valve, compressor system
034 026 0027
 0692 183

Application info

F 2100 (07/78-08/91)	F 3200 (01/90-10/93)
F 2300 (07/78-10/93)	F 3300 (06/81-09/91)
F 2500 (02/82-08/91)	F 3600 (06/85-09/91)
F 2800 (01/74-09/91)	SB (---)
F 2900 (01/90-10/93)	

Valve, compressor system
12-34 026 0002
 1300 662

Notes

Multiport Valve

References

1300 662	1374 724
----------	----------

Application info

75 CF (02/98-12/00)	95 XF (01/97-09/02)
85 CF (02/98-12/00)	

Relay valve
034 043 0073
 1304 635

Notes

Pressure [bar]	8
Thread Size	M24x1,5
Number of Inlets / Outlets	2

References

1304 635	1505 210
----------	----------

Application info

75 (07/92-02/98)	CF 65 (01/01--)
75 CF (02/98-12/00)	CF 75 (01/01--)
85 (07/92-02/98)	CF 85 (01/01--)
85 CF (02/98-12/00)	LF 45 (01/01--)
95 (09/87-01/98)	LF 55 (01/01--)
95 XF (01/97-09/02)	



2

034 043 0069
1506 488

Relay valve



Notes

Pressure [bar] 8.1
Number of Inlets / Outlets 4

References

1302 103 1506 488

Application info

75 (07/92-02/98)
75 CF (02/98-12/00)
85 (07/92-02/98)

85 CF (02/98-12/00)
95 (09/87-01/98)
95 XF (01/97-09/02)

034 026 0030
0262 633

Multiway valve



Notes

Pressure [bar] 8.1

References

0262 633 262633

Application info

F 2700 (01/90-10/93)

034 026 0026
0609 715

Multiway valve



Notes

Pressure [bar] 8

References

0609 715 609715





Multiway valve

034 026 0026
0609 715



Application info

F 1700 (12/86-02/95)
F 1900 (12/86-09/93)
F 2100 (07/78-08/91)

F 2300 (07/78-10/93)
F 2500 (02/82-08/91)
F 2700 (01/90-10/93)



034 026 0015
0386 930

Shift rod connector



Notes

Thread Measurement 2	with right-hand thread
Thread Measurement 1	M14x1,5
Length [mm]	M10x1
Cone Size [mm]	88
	12

References

0386 930	386930
----------	--------

Application info

95 (09/87-01/98)	F 1900 (12/86-09/93)
95 XF (01/97-09/02)	F 2100 (07/78-08/91)
F 1100 (01/78-11/90)	F 2300 (07/78-10/93)
F 1300 (07/78-12/92)	F 2500 (02/82-08/91)
F 1600 (01/70-08/91)	F 2800 (01/74-09/91)
F 1700 (12/86-02/95)	F 3300 (06/81-09/91)
F 1800 (01/70-08/91)	F 3600 (06/85-09/91)

034 026 0017
1249 088

Shift rod connector



Notes

Thread Measurement 2	with left-hand thread
Thread Measurement 1	M12x1,75
Length [mm]	M10x1,5
Cone Size [mm]	55
	12.8

References

0592 106	0656 084
592106	1249 088
656084	

Counterpart

034 026 0018

Application info

75 (07/92-02/98)	85 CF (02/98-12/00)
75 CF (02/98-12/00)	95 (09/87-01/98)
85 (07/92-02/98)	95 XF (01/97-09/02)

034 026 0018

1249 129

Shift rod connector
Notes

	with right-hand thread
Thread Measurement 2	M12x1,75
Thread Measurement 1	M10x1,5
Length [mm]	55
Cone Size [mm]	10.8

References

0589 333	0656 085
589333	1249 129
656085	

Counterpart

034 026 0017

Application info

75 (07/92-02/98)	85 CF (02/98-12/00)
75 CF (02/98-12/00)	95 (09/87-01/98)
85 (07/92-02/98)	95 XF (01/97-09/02)

Switch, splitter gearbox
14-34 043 0001

1374 723

References

1297 004	1787556
1374 723	

Application info

75 CF (02/98-12/00)	CF 75 (01/01--)
85 CF (02/98-12/00)	CF 85 (01/01--)
95 XF (01/97-09/02)	

Switch, splitter gearbox
14-34 154 0001

1457 275

Notes

Number of ports	4
	with threaded coupling
Voltage [V]	24

References

1303 948	1457 275
1379 772	





14-34 154 0001
1457 275

Switch, splitter gearbox

<p>Application info 75 CF (02/98-12/00) 85 CF (02/98-12/00)</p>	<p>95 XF (01/97-09/02)</p>
--	----------------------------

14-34 154 0002
1457 276

Switch, splitter gearbox



Notes	
Number of ports	4
Voltage [V]	24

References	
1457 276	

Application info	
95 XF (01/97-09/02)	
CF 65 (01/01--)	

CF 75 (01/01--)	
CF 85 (01/01--)	

034 026 0025
0106 321

Neutral safety switch



Notes	
Operating Pressure [bar]	Pneumatic 8

References	
0106 321	106321

Application info	
F 1700 (12/86-02/95)	
F 1900 (12/86-09/93)	
F 2100 (07/78-08/91)	

F 2300 (07/78-10/93)	
F 2500 (02/82-08/91)	
F 2800 (01/74-09/91)	



3

034 029 0026
1506 468

Clutch booster



Notes

Force output F [N]
Operating Pressure [bar]
Stroke [mm]

Brake Fluid
6200
10
85

References

1506 468

Application info

XF 95 (09/02-12/06)

034 042 0016
1518 244

Clutch booster



Notes

Force output F [N]
Operating Pressure [bar]
Stroke [mm]

Brake Fluid
6000
10
58

References

1518 244

Application info

F 1000 (12/86-12/92)

034 029 0025
1518 252

Clutch booster



Notes

Pressure [bar]
Force output F [N]
Stroke [mm]

Brake Fluid
10
6000
50

References

1518 252

Application info

F 2900 (01/90-10/93)

14-34 011 8086
 0118 086

Repair kit, kingpin
References

0118 086 118086

Application info

F 1000 (12/86-12/92)

14-34 068 1706
 0681 706

Repair kit, kingpin
Notes

Outer Diameter [mm]	Disc Brake
Outer Diameter [mm]	31.5
Length [mm]	50
	270
	with ball bearing
	Left and right

References

0681 706 681706

Application info

75 (07/92-02/98)	85 CF (02/98-12/00)
75 CF (02/98-12/00)	95 (09/87-01/98)
85 (07/92-02/98)	95 XF (01/97-09/02)

14-34 162 0001
 0361 477

Rubber stop, suspension
Notes

Outer Diameter [mm]	74
Height [mm]	11
	Left and right

References

 0361 477 1676 777
 361477



14-34 162 0001
0361 477

Rubber stop, suspension

Application info

65 CF (02/98-12/00)
75 CF (02/98-12/00)

85 CF (02/98-12/00)
95 XF (01/97-09/02)

14-34 032 0001
1357 764

Bushing, leaf spring



Notes

Inner Diameter [mm]	24.2
Outer Diameter [mm]	63
Height [mm]	86
	Front Axle

References

1357 764

Application info

65 CF (02/98-12/00)
75 CF (02/98-12/00)
85 CF (02/98-12/00)
CF 65 (01/01--)

CF 75 (01/01--)
CF 85 (01/01--)
LF 55 (01/01--)

14-34 032 0002
1368 283

Bushing, leaf spring



Notes

Inner Diameter [mm]	24
Outer Diameter [mm]	63
Height [mm]	106
	Rear Axle
	Front Axle

References

1368 283

Application info

65 CF (02/98-12/00)
75 CF (02/98-12/00)
85 CF (02/98-12/00)

CF 65 (01/01--)
CF 75 (01/01--)
CF 85 (01/01--)

14-34 032 0003
 1671 219

Bushing, leaf spring
Notes

Inner Diameter [mm]	24
Outer Diameter [mm]	61
Height [mm]	86
	Rear Axle
	Front Axle

References

1671 219

Application info

85 CF (02/98-12/00)	CF 75 (01/01--)
95 XF (01/97-09/02)	CF 85 (01/01--)

Mount, leaf spring
14-34 742 0001
 1779 767

Notes

	Rubber-metal Bearing
Height [mm]	205
Width [mm]	135
Length [mm]	220
	Left and right

References

1699 564	1779 767
----------	----------

Application info

75 CF (02/98-12/00)	CF 75 (01/01--)
85 CF (02/98-12/00)	CF 85 (01/01--)
95 XF (01/97-09/02)	

Control arm
14-36 050 0002
 1892 492

Notes

	Steel
Hole Pitch 1/ Hole Pitch 2	152mm/152mm
Bore Ø [mm]	23
Pipe Ø [mm]	48
Length [mm]	609
	Wishbone (CV)
	Rear Axle

References

0080 521	1617 096
80521	1793 875
1361 651	1817 808
1368 270	1892 482
1390 932	1892 492





14-36 050 0002
1892 492

Control arm

Application info

65 CF (02/98-12/00)
75 CF (02/98-12/00)

85 CF (02/98-12/00)
95 XF (01/97-09/02)

14-36 050 0009
0099 990

Rod/strut, suspension



Notes

Bore Ø 1 [mm]	17
Bore Ø 2 [mm]	17
	Guide Rod
Hole Pitch 1/ Hole Pitch 2	115mm/115mm
Pipe Ø [mm]	46
Length [mm]	665
	Left and right

References

0099 990	99990
099 990	

Application info

75 CF (02/98-12/00)
85 CF (02/98-12/00)
CF 75 (01/01--)

CF 85 (01/01--)
XF 105 (10/05--)
XF 95 (09/02-12/06)

14-36 050 0004
1261 101

Rod/strut, suspension



Notes

Bore Ø 1 [mm]	19
Bore Ø 2 [mm]	21
	Guide Rod
Hole Pitch 1/ Hole Pitch 2	130mm/152mm
Pipe Ø [mm]	50
Length [mm]	390
	Left and right

References

1261 101

Parts list

034 058 0017	Repair kit, control arm
12-34 220 6108	Repair kit, control arm

Application info

CF 75 (01/01--)
CF 85 (01/01--)

XF 105 (10/05--)
XF 95 (09/02-12/06)

4

14-34 035 0001
 1817 809

Rod/strut, suspension
Notes

Bore Ø 1 [mm]	21
Bore Ø 2 [mm]	21
	Push Rod
	Molecular Bearing
Hole Pitch 1/ Hole Pitch 2	130mm/130mm
Pipe Ø [mm]	48
Length [mm]	611
	Rear Axle left and right

References

0267 743	1656 428
1361 649	1817 809
1361 650	

Application info

85 (07/92-02/98)	CF 85 (01/01--)
95 (09/87-01/98)	LF 55 (01/01--)
95 XF (01/97-09/02)	XF 105 (10/05--)
CF 65 (01/01--)	XF 95 (09/02-12/06)
CF 75 (01/01--)	

Repair kit, control arm
14-36 035 0003
 0513 757

Notes

Hole Pitch 1/ Hole Pitch 2	130
Thickness [mm]	30
	for drag link
	Rear Axle

References

0513 757	691 709
513 757	0691 709

Application info

95 XF (01/97-09/02)	LF 55 (01/01--)
CF 65 (01/01--)	XF 105 (10/05--)
CF 75 (01/01--)	XF 95 (09/02-12/06)
CF 85 (01/01--)	



12-34 230 6051
0689 748

Repair kit, control arm



Notes

Hole Pitch 1/ Hole Pitch 2	115
Bore Ø [mm]	17
Thickness [mm]	24
Outer Diameter [mm]	75
Length [mm]	150
	for drag link Rear Axle

References

0689 748	689748
----------	--------

Application info

75 CF (02/98-12/00)
85 CF (02/98-12/00)

95 (09/87-01/98)
95 XF (01/97-09/02)

12-34 001 0009
0689 761

Repair kit, control arm



Notes

Hole Pitch 1/ Hole Pitch 2	130
Bore Ø [mm]	21
	for drag link Front Axle

References

0689 761	689761
----------	--------

Application info

75 CF (02/98-12/00)
95 XF (01/97-09/02)
CF 75 (01/01--)

CF 85 (01/01--)
XF 105 (10/05--)
XF 95 (09/02-12/06)

034 035 0028
0691 703

Repair kit, control arm



Notes

Bore Ø [mm]	21
Thickness [mm]	24
Outer Diameter [mm]	85
Length [mm]	152
	for wishbone (CV) Front and Rear Rear Axle

References

0691 703	691703
----------	--------



Repair kit, control arm
034 035 0028
 0691 703

Application info

F 2100 (07/78-08/91)	F 2800 (01/74-09/91)
F 2200 (01/71-11/80)	F 2900 (01/90-10/93)
F 2300 (07/78-10/93)	F 3200 (01/90-10/93)
F 2500 (02/82-08/91)	F 3300 (06/81-09/91)
F 2600 (02/72-12/73)	F 3600 (06/85-09/91)
F 2700 (01/90-10/93)	

Repair kit, control arm
034 058 0019
 0693 778

Notes

Hole Pitch 1/ Hole Pitch 2	152
Bore Ø [mm]	21
	without bolts
	for wishbone (CV)
	Rear Axle

References

0693 778	693778
----------	--------

Application info

95 (09/87-01/98)	95 XF (01/97-09/02)
------------------	---------------------

Repair kit, control arm
12-34 270 6079
 0696 321

Notes

Hole Pitch 1/ Hole Pitch 2	152
Bore Ø [mm]	23
Thickness [mm]	24
Outer Diameter [mm]	95
Length [mm]	193
	for wishbone (CV)
	Rear Axle
	Front Axle

References

0696 321	696321
----------	--------

Application info

65 CF (02/98-12/00)	F 2500 (02/82-08/91)
75 CF (02/98-12/00)	F 2700 (01/90-10/93)
85 CF (02/98-12/00)	F 2800 (01/74-09/91)
95 (09/87-01/98)	F 2900 (01/90-10/93)
95 XF (01/97-09/02)	F 3200 (01/90-10/93)
F 2100 (07/78-08/91)	F 3300 (06/81-09/91)
F 2300 (07/78-10/93)	F 3600 (06/85-09/91)



14-34 032 0004
0268 043

Bushing, stabilizer

Notes

Inner Diameter [mm]	25
Outer Diameter [mm]	35
Height [mm]	23
	Left and right

References

0268 043	268043
----------	--------

Application info

75 CF (02/98-12/00)

85 CF (02/98-12/00)

14-36 010 0028
1402 562

Bushing, stabilizer



Notes

Inner Diameter [mm]	26.5
Outer Diameter [mm]	52.5
Height [mm]	63
	Left and right

References

1402 562

Application info

CF 75 (01/01--)

14-36 010 0029
0082 522

Mount, stabilizer



Notes

Inner Diameter [mm]	17
Outer Diameter [mm]	55
Height [mm]	130
	Front Axle

References

0082 522	82522
082522	

Application info

SB (---)

14-36 010 0010
 0268 044

Mount, stabilizer
Notes

Inner Diameter [mm]	55
Outer Diameter [mm]	84
Outer Diameter [mm]	70
Height [mm]	75
	Rear

References

0268 044	268044
----------	--------

Application info

95 (09/87-01/98)

Mount, stabilizer
14-36 010 0011
 0268 045

Notes

Inner Diameter [mm]	50
Inner Diameter [mm]	82.5
Outer Diameter [mm]	70
Height [mm]	75
	Rear

References

0268 045	268045
----------	--------

Application info

95 (09/87-01/98)

F 2100 (07/78-08/91)

F 2300 (07/78-10/93)

F 2500 (02/82-08/91)

F 2800 (01/74-09/91)

F 3300 (06/81-09/91)

Mount, stabilizer
14-36 010 0002
 0274 650

Notes

Inner Diameter [mm]	40
Outer Diameter [mm]	60
Height [mm]	23.5
	Outer
	Front Axle

References

0274 650	274650
----------	--------





14-36 010 0002
0274 650

Mount, stabilizer

Application info
75 (07/92-02/98)
85 (07/92-02/98)
95 (09/87-01/98)
F 1100 (01/78-11/90)

F 1300 (07/78-12/92)
F 1700 (12/86-02/95)
F 1900 (12/86-09/93)

14-36 010 0003
0274 651

Mount, stabilizer



Notes
Inner Diameter [mm] 50
Outer Diameter [mm] 70
Outer Diameter [mm] 59
Height [mm] 23.5
Rear

References
0274 651 274651

Application info
65 CF (02/98-12/00)
75 CF (02/98-12/00)
85 (07/92-02/98)
85 CF (02/98-12/00)
95 (09/87-01/98)
95 XF (01/97-09/02)

F 1700 (12/86-02/95)
F 1900 (12/86-09/93)
F 2100 (07/78-08/91)
F 2300 (07/78-10/93)
F 2500 (02/82-08/91)
F 2700 (01/90-10/93)

14-36 010 0004
0290 825

Mount, stabilizer



Notes
Inner Diameter [mm] 30
Outer Diameter [mm] 55
Height [mm] 60
Rear
Front

References
0259 524 0290 825
259524 0299 106
290825 299106

Application info
65 CF (02/98-12/00)
75 CF (02/98-12/00)
85 CF (02/98-12/00)
95 XF (01/97-09/02)
F 1700 (12/86-02/95)

F 1900 (12/86-09/93)
F 2100 (07/78-08/91)
F 2300 (07/78-10/93)
F 2500 (02/82-08/91)
F 2700 (01/90-10/93)

4

14-36 010 0005
 0295 726

Mount, stabilizer
Notes

Inner Diameter [mm]	20
Outer Diameter [mm]	55
Height [mm]	56
	Rear
	Rear Axle

References

0295 726	295726
----------	--------

Application info

65 (03/93-02/98)	85 (07/92-02/98)
75 (07/92-02/98)	

14-36 010 0021
 0298 498

Mount, stabilizer
Notes

Inner Diameter [mm]	62
Outer Diameter [mm]	93
Height [mm]	70
	Front Axle
	Rear

References

0298 498	298498
----------	--------

Application info

75 CF (02/98-12/00)	95 (09/87-01/98)
85 CF (02/98-12/00)	

14-36 010 0013
 0366 351

Mount, stabilizer
Notes

Inner Diameter [mm]	65
Outer Diameter [mm]	84
Height [mm]	60
	Rear

References

0366 351	366351
----------	--------

Application info

95 (09/87-01/98)	95 XF (01/97-09/02)
------------------	---------------------



14-36 010 0001
0538 329

Mount, stabilizer



Notes

Inner Diameter [mm]	42
Outer Diameter [mm]	84
Outer Diameter [mm]	74
Height [mm]	60
	Rear
	Front

References

0538 329	538329
----------	--------

Application info

95 (09/87-01/98)

14-36 010 0014
0558 864

Mount, stabilizer



Notes

Inner Diameter [mm]	57
Outer Diameter [mm]	85
Height [mm]	60.5
	Rear
	Front

References

0558 864	558864
----------	--------

Application info

65 CF (02/98-12/00)
75 CF (02/98-12/00)
85 CF (02/98-12/00)

95 XF (01/97-09/02)
F 2300 (07/78-10/93)
F 2700 (01/90-10/93)

14-36 010 0016
0763 523

Mount, stabilizer



Notes

Inner Diameter 1 [mm]	51
Inner Diameter [mm]	51
Outer Diameter 2 [mm]	85
Outer Diameter 1 [mm]	74
Height [mm]	60
	Rear
	Front

References

0763 523	763523
----------	--------



14-36 010 0016
 0763 523

Mount, stabilizer
Application info

75 CF (02/98-12/00)	CF 85 (01/01--)
85 CF (02/98-12/00)	F 1700 (12/86-02/95)
95 XF (01/97-09/02)	F 1900 (12/86-09/93)
CF 75 (01/01--)	

14-36 010 0007
 1283 618

Mount, stabilizer
Notes

Inner Diameter [mm]	20
Outer Diameter [mm]	60
Height [mm]	60
	Outer
	Rear Axle

References

1283 618

Application info

85 CF (02/98-12/00)	95 XF (01/97-09/02)
---------------------	---------------------

14-36 010 0015
 1323 838

Mount, stabilizer
Notes

Inner Diameter [mm]	49
Outer Diameter [mm]	93.5
Outer Diameter [mm]	83
Height [mm]	61
	Rear
	Rear Axle

References

1323 838

Application info

65 CF (02/98-12/00)	CF 65 (01/01--)
75 CF (02/98-12/00)	CF 75 (01/01--)
85 CF (02/98-12/00)	CF 85 (01/01--)
95 XF (01/97-09/02)	



14-36 010 0020
1323 839

Mount, stabilizer



Notes

Inner Diameter [mm]	55
Outer Diameter [mm]	83
Height [mm]	60
	Rear Axle

References

1323 839

Application info

75 CF (02/98-12/00)

14-36 010 0019
1400 147

Mount, stabilizer



Notes

Inner Diameter [mm]	33.5
Outer Diameter 2 [mm]	57.5
Outer Diameter 1 [mm]	53
Height [mm]	62.5
	Front Axle

References

1400 147

Application info

75 CF (02/98-12/00)
85 CF (02/98-12/00)

95 XF (01/97-09/02)

14-36 010 0023
1402 587

Mount, stabilizer



Notes

Inner Diameter [mm]	46
	Front Axle

References

1402 587

Application info

75 CF (02/98-12/00)

14-36 010 0022
 1402 590

Mount, stabilizer
Notes

 Inner Diameter [mm] 48
 Front Axle

References

1402 590

Application info

75 CF (02/98-12/00)

14-36 010 0018
 1732 886

Mount, stabilizer
Notes

 Inner Diameter [mm] 39
 Outer Diameter 2 [mm] 71
 Outer Diameter 1 [mm] 63
 Height [mm] 60
 Front Axle

References

1288 000 1732 886

Application info

65 CF (02/98-12/00)	95 XF (01/97-09/02)
75 CF (02/98-12/00)	CF 75 (01/01--)
85 CF (02/98-12/00)	CF 85 (01/01--)

14-36 010 0017
 1732 887

Mount, stabilizer
Notes

 Inner Diameter [mm] 42.5
 Outer Diameter [mm] 60
 Height [mm] 60
 Front Axle

References

1291 233 1732 887





14-36 010 0017
1732 887

Mount, stabilizer

Application info

75 CF (02/98-12/00)
85 CF (02/98-12/00)
95 XF (01/97-09/02)

CF 75 (01/01--)
CF 85 (01/01--)
LF 45 (01/01--)

14-36 010 0027
0274 651

Repair kit, stabilizer bushing



Notes

Inner Diameter [mm]	50
Outer Diameter [mm]	60
Height [mm]	23.5
	Rear Axle
	Front Axle

References

0274 651	274651
----------	--------

Application info

75 CF (02/98-12/00)
85 CF (02/98-12/00)

95 XF (01/97-09/02)

14-34 032 0006
1283 618

Repair kit, stabilizer bushing



Notes

Inner Diameter [mm]	65
Outer Diameter [mm]	84
Height [mm]	50
	Rear Axle

References

0286 369	0366 351
286369	366351
311049	1283 618
0311 049	

Parts list

14-36 010 0013	Mount, stabilizer
14-36 032 0007	Mount, stabilizer

Application info

95 (09/87-01/98)

95 XF (01/97-09/02)

14-36 010 0025
 1283 618

Repair kit, stabilizer bushing
Notes

Inner Diameter [mm]	20
Outer Diameter [mm]	60
Height [mm]	59.5
	Rear Axle

References

1283 618

Parts list

14-36 010 0007	Mount, stabilizer
----------------	-------------------

Application info

65 CF (02/98-12/00)	CF 75 (01/01--)
75 CF (02/98-12/00)	CF 85 (01/01--)
85 CF (02/98-12/00)	LF 55 (01/01--)
95 XF (01/97-09/02)	

Wheel bearing kit
14-34 650 0001
 1801 592

Notes

Inner Diameter [mm]	70
Outer Diameter [mm]	125
Height [mm]	114
	Front Axle left and right

References

1801 592

Application info

75 CF (02/98-12/00)	CF 85 (01/01--)
85 CF (02/98-12/00)	LF 55 (01/01--)
CF 65 (01/01--)	XF 105 (10/05--)
CF 75 (01/01--)	XF 95 (09/02-12/06)



034 650 0001
0626 875

Wheel bearing



Notes

Inner Diameter [mm]	50
Outer Diameter [mm]	110
Height [mm]	42.25
DIN / ISO	32310 A
	Tapered Roller Bearing
	Outer
	Rear Axle left and right
	Front Axle left and right

References

0556 289	626875
556289	0626 875

Application info

75 (07/92-02/98)	F 2100 (07/78-08/91)
75 CF (02/98-12/00)	F 2300 (07/78-10/93)
85 (07/92-02/98)	F 2500 (02/82-08/91)
85 CF (02/98-12/00)	F 2800 (01/74-09/91)
95 (09/87-01/98)	F 3300 (06/81-09/91)
95 XF (01/97-09/02)	F 3600 (06/85-09/91)
F 1600 (01/70-08/91)	

12-14 650 0005
0636 820

Wheel bearing



Notes

Inner Diameter [mm]	45
Outer Diameter [mm]	85
Height [mm]	32.2
	Tapered Roller Bearing
	Outer
	Front Axle

References

0636 820	636820
----------	--------

Application info

F 600 (12/86-12/92)	LF 55 (01/01--)
F 800 (12/86-08/91)	

4

Wheel bearing
14-34 650 0002
 1400 291

Notes

Inner Diameter [mm]	90
Outer Diameter [mm]	160
Height [mm]	125
	Rear Axle

References

1400 291	1705 686
1408 086	

Application info

LF 55 (01/01--)

Wheel bearing
16-34 650 0001
Notes

Inner Diameter [mm]	93.8
Outer Diameter [mm]	148
Height [mm]	135
	Rear Axle

Application info

XF 105 (10/05--)

4



034 046 0000
0229 348

Hydraulic filter, steering system



Notes

Thickness [mm]	100
Inner Diameter [mm]	17.1
Outer Diameter [mm]	59

References

0229 348	229348
----------	--------

Application info

75 (07/92-02/98)	F 2000 (01/70-12/79)
75 CF (02/98-12/00)	F 2100 (07/78-08/91)
85 (07/92-02/98)	F 2200 (01/71-11/80)
85 CF (02/98-12/00)	F 2300 (07/78-10/93)
95 (09/87-01/98)	F 2500 (02/82-08/91)
95 XF (01/97-09/02)	F 2600 (02/72-12/73)
CF 65 (01/01--)	F 2700 (01/90-10/93)
CF 75 (01/01--)	F 2800 (01/74-09/91)
CF 85 (01/01--)	F 2900 (01/90-10/93)
F 1100 (01/78-11/90)	F 3200 (01/90-10/93)
F 1200 (01/69-12/81)	F 3300 (06/81-09/91)
F 1300 (07/78-12/92)	F 3600 (06/85-09/91)
F 1400 (02/72-12/81)	F 800 (12/86-08/91)
F 1500 (-08/91)	F 900 (01/75-11/88)
F 1600 (01/70-08/91)	LF 45 (01/01--)
F 1700 (12/86-02/95)	LF 55 (01/01--)
F 1800 (01/70-08/91)	N 2800 (01/81-09/91)
F 1900 (12/86-09/93)	XF 95 (09/02-12/06)

14-36 040 0004
0067 389

Tie rod end



Notes

Thread Measurement 2	Nut with lateral notches with right-hand thread
Thread Measurement 1	M48x1,5
Length [mm]	M24x1,5
	133
	for left-/right-hand traffic
Cone Size [mm]	30
	Front Axle

References

0067 389	67389
067389	

Counterpart

14-36 040 0003

Application info

75 (07/92-02/98)	85 CF (02/98-12/00)
75 CF (02/98-12/00)	95 (09/87-01/98)
85 (07/92-02/98)	95 XF (01/97-09/02)

036 020 0016
 0608 530

Tie rod end
Notes

Thread Measurement 2 M24x1,5
 Thread Measurement 1 M16x1,5
 Length [mm] 104
 Cone Size [mm] 20
 Front Axle

References

0608 530 608530

Counterpart

036 020 0015

Application info

75 CF (02/98-12/00)	95 (09/87-01/98)
85 CF (02/98-12/00)	95 XF (01/97-09/02)

Tie rod end
12-36 020 0007
 1142 173

Notes

Thread Measurement 2 M30x1,5
 Thread Measurement 1 M20x1,5
 Length [mm] 126
 Cone Size [mm] 26
 for left-/right-hand traffic
 Front Axle

References

0069 867	0608 000
069867	608000
69867	1142 173
161376	1326 866
0161 376	

Application info

F 1600 (01/70-08/91)	F 1800 (01/70-08/91)
----------------------	----------------------



036 020 0003
1228 114

Tie rod end



Notes

Thread Measurement 2
Thread Measurement 1
Length [mm]

Cone Size [mm]

Nut with lateral notches
with right-hand thread
M28x1,5
M18x1,5
106
for left-/right-hand traffic
22
Front Axle

References

0100 197	607453
100197	0607 453
110197	1228 114
0110 197	1326 864
0607 451	1373 135
607451	ACU9242

Parts list

036 030 0041	Drag link
--------------	-----------

Counterpart

036 020 0008

Application info

F 1200 (01/69-12/81)	F 1900 (12/86-09/93)
F 1700 (12/86-02/95)	

036 020 0005
1228 115

Tie rod end



Notes

Thread Measurement 2
Thread Measurement 1
Length [mm]

Cone Size [mm]

Nut with lateral notches
with left-hand thread
M30x1,5
M24x1,5
125
for left-/right-hand traffic
30
Front Axle

References

0607 053	0696 205
607053	1228 115
696205	

Counterpart

036 020 0004

Application info

75 (07/92-02/98)	F 1600 (01/70-08/91)
75 CF (02/98-12/00)	F 1700 (12/86-02/95)
85 (07/92-02/98)	F 1900 (12/86-09/93)
85 CF (02/98-12/00)	F 2000 (01/70-12/79)
95 (09/87-01/98)	F 2100 (07/78-08/91)
95 XF (01/97-09/02)	

Tie rod end 
036 020 0005/HD
 1228 115

Notes

Thread Measurement 2 M30x1,5
 Thread Measurement 1 M24x1,5
 Length [mm] 125
 Cone Size [mm] 30
 Reinforced Version Front Axle

References

0607 053	0696 225
607053	696225
696205	1228 115
0696 205	

Counterpart

036 020 0004/HD

Application info

75 (07/92-02/98)	F 1600 (01/70-08/91)
75 CF (02/98-12/00)	F 1700 (12/86-02/95)
85 (07/92-02/98)	F 1900 (12/86-09/93)
85 CF (02/98-12/00)	F 2000 (01/70-12/79)
95 (09/87-01/98)	F 2100 (07/78-08/91)

Tie rod end 
036 020 0004/HD
 1257 890

Notes

Thread Measurement 2 M30x1,5
 Thread Measurement 1 M24x1,5
 Length [mm] 125
 Cone Size [mm] 30
 Reinforced Version Front Axle

References

0607 981	0698 450
607981	698450
696226	1257 890
0696 226	1603 789

Counterpart

036 020 0005/HD

Application info

85 (07/92-02/98)	95 (09/87-01/98)
------------------	------------------



036 020 0002
1315 447

Tie rod end



Notes

Thread Measurement 2
Thread Measurement 1
Length [mm]
Cone Size [mm]

Nut with lateral notches
with left-hand thread
M30x1,5
M20x1,5
114
for left-/right-hand traffic
26
Front Axle

References

0311 300	1315 447
311300	1319 838
607998	1338 714
0607 998	

Counterpart

036 020 0001

Application info

75 CF (02/98-12/00)	F 1600 (01/70-08/91)
F 1300 (07/78-12/92)	F 1700 (12/86-02/95)
F 1400 (02/72-12/81)	F 1800 (01/70-08/91)
F 1500 (-08/91)	F 1900 (12/86-09/93)

036 020 0001
1326 896

Tie rod end



Notes

Thread Measurement 2
Thread Measurement 1
Length [mm]
Cone Size [mm]

Nut with lateral notches
with right-hand thread
M30x1,5
M20x1,5
114
for left-/right-hand traffic
26
Front Axle

References

0586 753	0694 360
586753	0698 609
0607 999	698609
0694 298	1229 944
694298	1326 896
694360	1331 925

Counterpart

036 020 0002

Application info

75 CF (02/98-12/00)

036 020 0008
 1373 137

Tie rod end
Notes

Thread Measurement 2 M28x1,5L
 Thread Measurement 1 M18x1,5
 Length [mm] 106
 Cone Size [mm] 22
 for left-/right-hand traffic
 Front Axle

References

0110 196 607452
 110196 1373 137
 0607 452 ACU9241

Counterpart

036 020 0003

Application info

F 1200 (01/69-12/81) F 1900 (12/86-09/93)
 F 1700 (12/86-02/95)

Tie rod end
12-36 020 0039
 1 389 190

Notes

Thread Measurement 2 M24x1,5
 Thread Measurement 1 M30x1,5
 Length [mm] 141
 Cone Size [mm] 26
 for left-/right-hand traffic
 Front Axle

References

1 389 190

Application info

65 CF (02/98-12/00) CF 75 (01/01--)
 75 CF (02/98-12/00) CF 85 (01/01--)
 85 CF (02/98-12/00) XF 105 (10/05--)
 95 XF (01/97-09/02) XF 95 (09/02-12/06)



036 020 0004
1603 789

Tie rod end



Notes

Thread Measurement 2
Thread Measurement 1
Length [mm]
Cone Size [mm]

Nut with lateral notches
with right-hand thread
M30x1,5
M24x1,5
125
for left-/right-hand traffic
30
Front Axle

References

0607 981	0698 450
607981	698450
696226	1257 890
0696 226	1603 789

Counterpart
036 020 0005

Application info

85 (07/92-02/98)	95 XF (01/97-09/02)
95 (09/87-01/98)	

036 020 0015

Tie rod end



Notes

Thread Measurement 2
Thread Measurement 1
Length [mm]
Cone Size [mm]

Nut with lateral notches
with left-hand thread
M24x1,5
M16x1,5
104
for left-/right-hand traffic
20
Front Axle

Counterpart
036 020 0016

Application info

75 CF (02/98-12/00)	95 (09/87-01/98)
85 CF (02/98-12/00)	95 XF (01/97-09/02)

5

14-36 631 0001
 1291 227

Hydraulic pump, P/S
Notes

	Hydraulic
	Cast Aluminium
Thread Measurement 2	M26x1,5
Number of ports	2
Thread Measurement 1	M16x1,5
Operating Pressure [bar]	150
	Anti-clockwise rotation

References

052663	1291 227
0526 63R	1 239 411R
1239 411	

Application info

75 (07/92-02/98)	85 CF (02/98-12/00)
75 CF (02/98-12/00)	95 (09/87-01/98)
85 (07/92-02/98)	95 XF (01/97-09/02)

Hydraulic pump, P/S
14-34 631 0004
 1375 507

Notes

	Hydraulic
	Steel
Thread Measurement 2	M26X1
Number of ports	2
Thread Measurement 1	M18x1,5
	Anti-clockwise rotation

References

1375 507

Application info

75 CF (02/98-12/00)	CF 75 (01/01--)
85 CF (02/98-12/00)	CF 85 (01/01--)



14-34 026 0003
1285 258

Gear shift knob

Notes

Outer Thread [mm]	M42x1,5
Number of ports	Manual Transmission
Length [mm]	3
	155

References

1285 258

Application info

75 CF (02/98-12/00)
85 CF (02/98-12/00)
95 XF (01/97-09/02)

CF 75 (01/01--)
CF 85 (01/01--)

14-12 319 0001
1322 255

Cabin air filter

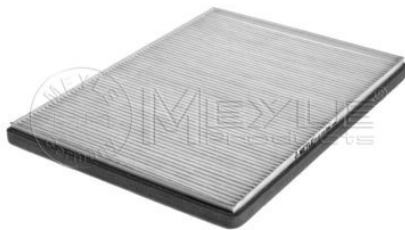

Notes

Height [mm]	23.5
Width [mm]	224
Length [mm]	338
	Filter Insert
	Particulate Filter

References

1322 255	1658 991
----------	----------

Application info

95 XF (01/97-09/02)

14-12 319 0005
1362 124

Cabin air filter



Notes

Height [mm]	38
Width [mm]	164
Length [mm]	260
	Filter Insert
	Particulate Filter

References

1362 124	1791 192
----------	----------



Cabin air filter
14-12 319 0005
 1362 124

Application info

 CF 65 (01/01--)
 CF 75 (01/01--)

CF 85 (01/01--)

Cabin air filter
14-12 319 0006
 1362 168

Notes

 Height [mm] 45.4
 Width [mm] 162.4
 Length [mm] 263
 Filter Insert
 Activated Carbon Filter

References

1362 168 1825 431

Application info

 CF 65 (01/01--)
 CF 75 (01/01--)

CF 85 (01/01--)

Cabin air filter
14-12 319 0004
 1600 428

Notes

 Height [mm] 20
 Width [mm] 105
 Length [mm] 230
 Filter Insert
 Particulate Filter

References

1600 428

Application info

LF 45 (01/01--)

LF 55 (01/01--)



14-12 319 0000
1825 428

Cabin air filter



Notes

Height [mm]	23.5
Width [mm]	169
Length [mm]	432
	Filter Insert
	Particulate Filter

References

1322 259	1825 428
1659 691	

Application info

75 CF (02/98-12/00)	CF 65 (01/01--)
85 CF (02/98-12/00)	CF 75 (01/01--)

14-34 089 0011
1271 385

Spacer, driver cab stabiliser



References

1271 385	1399 159
----------	----------

Application info

65 CF (02/98-12/00)	95 (09/87-01/98)
75 CF (02/98-12/00)	95 XF (01/97-09/02)
85 CF (02/98-12/00)	CF 85 (01/01--)

14-34 089 0010
1266 426

Bushing, driver cab suspension



Notes

Inner Diameter 1 [mm]	25
Outer Diameter 2 [mm]	51
Outer Diameter 1 [mm]	30
Height 1 [mm]	20.3
	Front

References

1266 426	1656 266
1399 160	

6



Bushing, driver cab suspension
14-34 089 0010
 1266 426

Application info

CF 85 (01/01-)

Bushing, driver cab suspension
14-34 089 0003
 1290 794

Notes

Inner Diameter 1 [mm]	20
Outer Diameter 1 [mm]	60
Height 2 [mm]	48
Height 1 [mm]	39
	Front

References

1290 794

Application info

95 (09/87-01/98)

95 XF (01/97-09/02)

Bushing, driver cab suspension
14-34 089 0001
 1314 545

Notes

Inner Diameter 1 [mm]	20
Outer Diameter 1 [mm]	90
Height 1 [mm]	70

References

1314 545

Application info

95 (09/87-01/98)

95 XF (01/97-09/02)



14-34 089 0005
1396 202

Bushing, driver cab suspension



Notes

Inner Diameter 1 [mm]	20
Outer Diameter 2 [mm]	83
Outer Diameter 1 [mm]	60
Height 1 [mm]	24
	Rear

References

1298 675	1438 837
1396 202	

Parts list

14-34 089 0009	Repair kit, driver cab mounting
----------------	---------------------------------

Application info

65 CF (02/98-12/00)
75 CF (02/98-12/00)

85 CF (02/98-12/00)

14-34 089 0006
1425 160

Bushing, driver cab suspension

Notes

Inner Diameter 1 [mm]	20
Outer Diameter 1 [mm]	75
Height 1 [mm]	62

References

1425 160

Application info

XF 95 (09/02-12/06)

14-34 089 0008
1694 967

Bushing, driver cab suspension



Notes

Inner Diameter 1 [mm]	30
Outer Diameter 1 [mm]	55
Height 1 [mm]	25
	Left and right

References

1694 967



Bushing, driver cab suspension
14-34 089 0008
 1694 967

Application info

XF 95 (09/02-12/06)

Repair kit, driver cab mounting
14-34 089 0008/S
 1243 049

References

1243 049	1964 968
1694 967	1964 969
1699 375	

Parts list

14-34 089 0008	Bushing, driver cab suspension
----------------	--------------------------------

Application info

XF 105 (10/05--)

XF 95 (09/02-12/06)

Repair kit, driver cab mounting
14-34 032 0009
 1314 545

References

1314 545

Parts list

14-34 089 0001	Bushing, driver cab suspension
----------------	--------------------------------

Application info

95 (09/87-01/98)

95 XF (01/97-09/02)



14-34 032 0010
1314 545

Repair kit, driver cab mounting



References

1314 545

Parts list

14-34 089 0001

Bushing, driver cab suspension

Application info

95 (09/87-01/98)

95 XF (01/97-09/02)

14-34 089 0009
1438 837

Repair kit, driver cab mounting



References

1298 675
1396 202

1438 837

Application info

65 CF (02/98-12/00)
75 CF (02/98-12/00)

85 CF (02/98-12/00)

14-34 910 0100
1315 942

Tilt pump, driver cab



References

1315 942

Application info

95 XF (01/97-09/02)

6

14-34 910 0101
 1450 902

Tilt pump, driver cab
References

1382 282	1914 281
1450 902	

Application info

65 CF (02/98-12/00)	F 1600 (01/70-08/91)
75 CF (02/98-12/00)	F 1900 (12/86-09/93)
85 CF (02/98-12/00)	F 2100 (07/78-08/91)
CF 75 (01/01--)	F 2300 (07/78-10/93)
CF 85 (01/01--)	F 2500 (02/82-08/91)
F 1100 (01/78-11/90)	LF 55 (01/01--)
F 1300 (07/78-12/92)	

14-34 910 1002
 1308 300

Tilt cylinder, driver cab
Notes

Outer Thread [mm]	M14x1,5
Outer Thread [mm]	M12x1,5
Pressure [bar]	250
Outer Diameter [mm]	50
Length 2 [mm]	1386
Length 1 [mm]	862
Stroke [mm]	524

References

1308 300	1346 200
----------	----------

Application info

75 CF (02/98-12/00)	95 XF (01/97-09/02)
85 CF (02/98-12/00)	LF 45 (01/01--)

14-34 910 0001
 1336 529

Ignition lock cylinder
References

1277 475	1336 529
----------	----------





14-34 910 0001
1336 529

Ignition lock cylinder

Application info

65 CF (02/98-12/00)
75 CF (02/98-12/00)
85 CF (02/98-12/00)

95 XF (01/97-09/02)
CF 65 (01/01--)
CF 75 (01/01--)

029 600 2470
1260 954

Wiper Blade



Notes

Length [in]
Length [mm]

Beam wiper blade
24
600
Front

References

1260 954

1260954G

Application info

65 (03/93-02/98)
65 CF (02/98-12/00)
75 (07/92-02/98)
75 CF (02/98-12/00)
85 (07/92-02/98)
85 CF (02/98-12/00)
CF 65 (01/01--)
CF 75 (01/01--)
CF 85 (01/01--)
F 1100 (01/78-11/90)

F 1500 (--08/91)
F 2600 (02/72-12/73)
F 500 (12/77-12/79)
F 600 (12/86-12/92)
F 700 (12/75-12/79)
F 800 (12/86-08/91)
F 900 (01/75-11/88)
N 2800 (01/81-09/91)
N 3300 (01/81-09/91)

029 500 2070/S
1517 862

Wiper Blade



Notes

Observe service information

Length [in]
Length [mm]

Beam wiper blade
Kit
20
500
Front

References

513952

1517 862

Application info

55 (11/95-12/00)



MEYLE no.	Ref. no.	Page
DAF		
012 094 0024	0265 045 265045	4
025 290 2423	BBU8177	41
025 290 8730	1439 324 1617 343 1797 053 1878 030	40
025 290 8730/S	1439 324	41
029 500 2070/S	513952 1517 862	98
029 600 2470	1260 954 1260954G	98
034 009 0003	1315 514	11
034 009 0013	1438 836 1604 476 1683 353	10
034 009 0015	0194 194 194194 1311 608	10
034 013 0006	1517 929 BBU5510	47
034 015 0005	0068 499 068499 68499	1
034 026 0014	1517 945	61
034 026 0015	0386 930 386930	58
034 026 0017	0592 106 592106 656084 0656 084 1249 088	58
034 026 0018	0589 333 589333 656085 0656 085 1249 129	59
034 026 0025	0106 321 106321	60
034 026 0026	0609 715 609715	56
034 026 0027	0069 237 069237 69237 692183 0692 183	54

MEYLE no.	Ref. no.	Page
DAF		
034 026 0030	0262 633 262633	56
034 029 0025	1518 252	62
034 029 0026	1506 468	62
034 035 0028	0691 703 691703	68
034 042 0001	0501 182 501182 706123 0706 123 FBU8648	52
034 042 0002	0691 602 691602 694277 0694 277	53
034 042 0003	0305 049 305049 533891 0533 891 0706 128 706128	54
034 042 0016	1518 244	62
034 042 0024	0587 805 587805	51
034 042 0033	1427 369	50
034 042 0034	0109 916 109916	49
034 042 0038	1504 961	50
034 042 0039	1519 232	50
034 042 0043	0695 751 695751	53
034 042 0051	0288 495 288495 307475 0307 475 0507 808 507808 587808 0587 808	51
034 042 0061	0689 511 689511 FBU9614	53
034 042 0062	0689 366 689366	52
034 043 0002	0303 055 303055	54



MEYLE no.	Ref. no.	Page
DAF		
	1325 345	
034 043 0005	1505 023	51
034 043 0039	0167 846 167846	52
034 043 0069	1302 103 1506 488	56
034 043 0073	1304 635 1505 210	55
034 046 0000	0229 348 229348	82
034 058 0019	0693 778 693778	69
034 533 0017	1315 698 1504 951	42
034 533 0031	1518 002	45
034 533 0032	1518 003	45
034 533 0035	1518 311	46
034 650 0001	0556 289 556289 626875 0626 875	80
036 020 0001	0586 753 586753 0607 999 0694 298 694298 694360 0694 360 0698 609 698609 1229 944 1326 896 1331 925	86
036 020 0002	0311 300 311300 607998 0607 998 1315 447 1319 838 1338 714	86
036 020 0003	0100 197 100197 110197 0110 197 0607 451 607451	84

MEYLE no.	Ref. no.	Page
DAF		
	607453 0607 453 1228 114 1326 864 1373 135 ACU9242	
036 020 0004	0607 981 607981 696226 0696 226 0698 450 698450 1257 890 1603 789	88
036 020 0004/HD	0607 981 607981 696226 0696 226 0698 450 698450 1257 890 1603 789	85
036 020 0005	0607 053 607053 696205 0696 205 1228 115	84
036 020 0005/HD	0607 053 607053 696205 0696 205 0696 225 696225 1228 115	85
036 020 0008	0110 196 110196 0607 452 607452 1373 137 ACU9241	87
036 020 0015	-	88
036 020 0016	0608 530 608530	83
050 007 1750	1638 698 1812 162	36
050 008 1215	1393 344	35



MEYLE no.	Ref. no.	Page
DAF		
050 008 1398	0067 690 067690 67690 490269 0490 269 CBU1182 CBU1532	33
050 008 1460	CBU 1716	37
050 008 1525	1388 161 1702 605	34
050 008 1720	1393 365	35
050 008 1915	1152 425 1372 669	34
050 008 2050	1393 280	35
050 008 2120	1444 203	36
050 008 2380	1398 637	36
050 009 1380	1654 398 1661 948	37
050 009 1424	1661 949 1661 954	37
052 010 0975	0679 733 679733	32
052 013 1000	1425 709	33
052 013 1050	0296 961 296961	32
052 013 1475	0238 770 238770 655043 0655 043	32
052 013 1525	248761 1265 398	33
052 013 1600	0067 681 067681 67681	31
12-14 650 0005	0636 820 636820	80
12-34 001 0009	0689 761 689761	68
12-34 026 0002	1300 662 1374 724	55
12-34 032 0000	0759 050 759050 1341 990 1445 900 1600 469	48
12-34 042 0010	1142 142	38

MEYLE no.	Ref. no.	Page
DAF		
	1198 153 1198 154 1448 915	
12-34 126 6017	0505 698 505698 689962 0689 962 1252 350	61
12-34 230 6051	0689 748 689748	68
12-34 270 6079	0696 321 696321	69
12-34 321 0004	0692 380 692380	4
12-34 323 0008	1296 851	10
12-34 899 0004	1697 325	1
12-36 020 0007	0069 867 069867 69867 161376 0161 376 0608 000 608000 1142 173 1326 866	83
12-36 020 0039	1 389 190	87
14-12 319 0000	1322 259 1659 691 1825 428	92
14-12 319 0001	1322 255 1658 991	90
14-12 319 0004	1600 428	91
14-12 319 0005	1362 124 1791 192	90
14-12 319 0006	1362 168 1825 431	91
14-12 321 0001	1638 054	7
14-12 321 0007	1363 023 1363 025 1638 026 1640 920 1657 522 1726 061 1789 292	8
14-12 321 0008	ACHH325	9
14-12 321 0009	APUC43	5



MEYLE no.	Ref. no.	Page
DAF		
	1433 690 1644 642 1667 999 1672 463	
14-28 282 0001	1303 061 1439 844 1684 900	25
14-33 220 0001	0683 225 683225 683586 0683 586 1609 871	25
14-33 220 0002	1664 762 1738 991 1778 280 1828 162	25
14-33 220 0003	0683 579 683 579 1399 150 1609 853 0683 579 R 683 579 R	24
14-34 000 0001	1398 620 1458 764 1614 978 1628 148	31
14-34 000 0002	1406 486 1702 525	30
14-34 000 0003	1627 625 1694 953 1695 242	30
14-34 000 0004	1638 696 1687 821 1699 240 1811 819	31
14-34 009 0002	0247 138 247138 247139 0247 139 1318 695	11
14-34 011 8086	0118 086 118086	63
14-34 018 0001	1397 764	3
14-34 018 0002	1397 766 1784 782	13
14-34 018 0004	1345 335	12

MEYLE no.	Ref. no.	Page
DAF		
14-34 018 0007	1399 494	3
14-34 018 0008	1399 760	13
14-34 018 0009	CBU 1251 CBU 1920	14
14-34 018 0010	0211 340 211340 236481 0236 481	1
14-34 018 0011	0267 714 267714	2
14-34 018 0012	0611 049 611049 661049 0661 049	2
14-34 018 0013	1629 393 1643 070 1948 921 1643 070G 1948 921G	4
14-34 018 0016	1433 649	13
14-34 026 0003	1285 258	90
14-34 032 0001	1357 764	64
14-34 032 0002	1368 283	64
14-34 032 0003	1671 219	65
14-34 032 0004	0268 043 268043	70
14-34 032 0006	0286 369 286369 311049 0311 049 0366 351 366351 1283 618	78
14-34 032 0009	1314 545	95
14-34 032 0010	1314 545	96
14-34 035 0001	0267 743 1361 649 1361 650 1656 428 1817 809	67
14-34 042 0005	1391 510	48
14-34 043 0001	1297 004 1374 723 1787556	59
14-34 068 1706	0681 706 681706	63



MEYLE no.	Ref. no.	Page
DAF		
14-34 089 0001	1314 545	93
14-34 089 0003	1290 794	93
14-34 089 0005	1298 675 1396 202 1438 837	94
14-34 089 0006	1425 160	94
14-34 089 0008	1694 967	94
14-34 089 0008/S	1243 049 1694 967 1699 375 1964 968 1964 969	95
14-34 089 0009	1298 675 1396 202 1438 837	96
14-34 089 0010	1266 426 1399 160 1656 266	92
14-34 089 0011	1271 385 1399 159	92
14-34 154 0001	1303 948 1379 772 1457 275	59
14-34 154 0002	1457 276	60
14-34 162 0001	0361 477 361477 1676 777	63
14-34 223 0001	1295 910 1607 794	26
14-34 223 0004	1371 329 1660 859 1871 493	28
14-34 223 0005	1626 237	26
14-34 223 0006	1684 655	27
14-34 232 0001	1263 571	21
14-34 232 0002	1308 285 1399 180 1448 197 1733 234	23
14-34 232 0003	1224 800	20
14-34 232 0004	1300 519 1315 854	22
14-34 232 0005	1291 218	22
14-34 232 0006	1376 260	23
14-34 232 0007	1293 812	22
14-34 232 0008	1236 096	21

MEYLE no.	Ref. no.	Page
DAF		
14-34 232 0009	1338 736	23
14-34 232 0010	1402 417 1403 248	24
14-34 232 0011	1282 146 1403 238	21
14-34 232 0012	1399 819	24
14-34 234 0001	1449 678 1449 679	19
14-34 234 0002	1737 460 1742 083 1806 713 1916 598	20
14-34 234 0003	1677 080 1693 441 1697 677 1732 273 1732 274 1806 712 1916 597	20
14-34 234 0004	1427 573 1666 098 1680 935	19
14-34 234 0005	1441 770 1441 773 1441 774 1449 676 1449 677 1666 156 1666 157 1680 937 1680 938	19
14-34 234 0006	1334 257 1334 259 1349 834 1349 835 1426 402 1436 105 1436 125	17
14-34 234 0007	1306 778 1376 148	16
14-34 234 0008	1259 622 1307 823	15
14-34 234 0009	1224 883 1224 885 1306 241 1306 242	15



MEYLE no.	Ref. no.	Page
DAF		
	1306 244 1328 797 1348 775 1349 755	
14-34 234 0010	1398 793	18
14-34 234 0011	1304 249 1305 179 1309 649 1311 271 1317 003 1330 723 1363 378	15
14-34 234 0012	1372 386	14
14-34 234 0013	1330 224 1330 724 1377 127 1377 197	16
14-34 234 0014	1397 382	18
14-34 234 0015	1382 108	17
14-34 234 0016	1372 387	17
14-34 234 0017	1319 779 1332 181 1334 261	16
14-34 234 0018	1402 415 1408 555 APUB185 APUC331	18
14-34 238 0001	1371 331 1615 509 1657 336 1743 703 1867 861	29
14-34 238 0002	1685 352	29
14-34 238 0003	1399 820	29
14-34 321 0001	1295 090 1353 115 1500 399 1664 524 1664 525	8
14-34 321 0003	0754 718 754 718 1314 531 1318 919	6
14-34 321 0004	1363 024 1638 006 1640 921	8

MEYLE no.	Ref. no.	Page
DAF		
	1656 513 1657 523 1726 060 1921 967 1933 740	
14-34 321 0005	ACHD040	9
14-34 321 0006	1433 697 1644 641 1668 000 1672 464 APUC944	7
14-34 321 0007	0693 076 693076 693096 0693 096	5
14-34 321 0008	1317 409	6
14-34 321 0009	MAK7603	9
14-34 321 0010	1346 885 1385 791	6
14-34 322 0001	1310 901	3
14-34 533 0001	1506 003	44
14-34 533 0002	0867 636 867636	47
14-34 533 0004	1230 594 1238 561 1315 691 1361 393 1778 553 1778 554	42
14-34 533 0010	1505 212	44
14-34 533 0011	TP01020001	46
14-34 533 0017	1504 930 1505 215	43
14-34 533 0018	1518 010	46
14-34 631 0004	1375 507	89
14-34 650 0001	1801 592	79
14-34 650 0002	1400 291 1408 086 1705 686	81
14-34 742 0001	1699 564 1779 767	65
14-34 899 0001	1371 332 1624 783 1740 758	28
14-34 910 0001	1277 475 1336 529	97



MEYLE no.	Ref. no.	Page
DAF		
14-34 910 0100	1315 942	96
14-34 910 0101	1382 282 1450 902 1914 281	97
14-34 910 1002	1308 300 1346 200	97
14-35 521 0003	1387 439 1640 561 1726 138 1783 346 1812 563 1812 582	38
14-35 521 0004	AMPA014 AMPB481 AMPB860 NJK2785	39
14-35 521 0005	AMPB887 MAK2578 PAK3546 PAK5513	40
14-35 521 0006	1403 758 1408 253 1408 671	39
14-36 010 0001	0538 329 538329	74
14-36 010 0002	0274 650 274650	71
14-36 010 0003	0274 651 274651	72
14-36 010 0004	0259 524 259524 290825 0290 825 0299 106 299106	72
14-36 010 0005	0295 726 295726	73
14-36 010 0007	1283 618	75
14-36 010 0010	0268 044 268044	71
14-36 010 0011	0268 045 268045	71
14-36 010 0013	0366 351 366351	73
14-36 010 0014	0558 864 558864	74

MEYLE no.	Ref. no.	Page
DAF		
14-36 010 0015	1323 838	75
14-36 010 0016	0763 523 763523	74
14-36 010 0017	1291 233 1732 887	77
14-36 010 0018	1288 000 1732 886	77
14-36 010 0019	1400 147	76
14-36 010 0020	1323 839	76
14-36 010 0021	0298 498 298498	73
14-36 010 0022	1402 590	77
14-36 010 0023	1402 587	76
14-36 010 0025	1283 618	79
14-36 010 0027	0274 651 274651	78
14-36 010 0028	1402 562	70
14-36 010 0029	0082 522 082522 82522	70
14-36 035 0003	0513 757 513 757 691 709 0691 709	67
14-36 040 0004	0067 389 067389 67389	82
14-36 050 0002	0080 521 80521 1361 651 1368 270 1390 932 1617 096 1793 875 1817 808 1892 482 1892 492	65
14-36 050 0004	1261 101	66
14-36 050 0009	0099 990 099 990 99990	66
14-36 631 0001	052663 0526 63R 1239 411 1291 227 1 239 411R	89



MEYLE no.	Ref. no.	Page
DAF		
16-34 032 0003	1365 935	49
16-34 223 0001	1700 772 1702 252	27
16-34 323 0009	1318 695	12
16-34 650 0001	-	81
534 003 0001	1400 071 1506 149 1525 416	43
812 321 0001	0667 078 667078 1207 748	5
834 029 0003	1504 842	61
834 533 0004	1305 844 1505 287	48





Ref. no.	MEYLE no.	Page
DAF		
052663	14-36 631 0001	89
0067 389	14-36 040 0004	82
067389	14-36 040 0004	82
67389	14-36 040 0004	82
0067 681	052 013 1600	31
067681	052 013 1600	31
67681	052 013 1600	31
0067 690	050 008 1398	33
067690	050 008 1398	33
67690	050 008 1398	33
0068 499	034 015 0005	1
068499	034 015 0005	1
68499	034 015 0005	1
0069 237	034 026 0027	54
069237	034 026 0027	54
69237	034 026 0027	54
0069 867	12-36 020 0007	83
069867	12-36 020 0007	83
69867	12-36 020 0007	83
0080 521	14-36 050 0002	65
80521	14-36 050 0002	65
0082 522	14-36 010 0029	70
082522	14-36 010 0029	70
82522	14-36 010 0029	70
0099 990	14-36 050 0009	66
099 990	14-36 050 0009	66
99990	14-36 050 0009	66
0100 197	036 020 0003	84
100197	036 020 0003	84
0106 321	034 026 0025	60
106321	034 026 0025	60
0109 916	034 042 0034	49
109916	034 042 0034	49
0110 196	036 020 0008	87
110196	036 020 0008	87
0110 197	036 020 0003	84
110197	036 020 0003	84
0118 086	14-34 011 8086	63
118086	14-34 011 8086	63
0161 376	12-36 020 0007	83
161376	12-36 020 0007	83
0167 846	034 043 0039	52
167846	034 043 0039	52
0194 194	034 009 0015	10
194194	034 009 0015	10
0211 340	14-34 018 0010	1

Ref. no.	MEYLE no.	Page
DAF		
211340	14-34 018 0010	1
0229 348	034 046 0000	82
229348	034 046 0000	82
0236 481	14-34 018 0010	1
236481	14-34 018 0010	1
0238 770	052 013 1475	32
238770	052 013 1475	32
0247 138	14-34 009 0002	11
247138	14-34 009 0002	11
0247 139	14-34 009 0002	11
247139	14-34 009 0002	11
248761	052 013 1525	33
0259 524	14-36 010 0004	72
259524	14-36 010 0004	72
0262 633	034 026 0030	56
262633	034 026 0030	56
0265 045	012 094 0024	4
265045	012 094 0024	4
0267 714	14-34 018 0011	2
267714	14-34 018 0011	2
0267 743	14-34 035 0001	67
0268 043	14-34 032 0004	70
268043	14-34 032 0004	70
0268 044	14-36 010 0010	71
268044	14-36 010 0010	71
0268 045	14-36 010 0011	71
268045	14-36 010 0011	71
0274 650	14-36 010 0002	71
274650	14-36 010 0002	71
0274 651	14-36 010 0003 14-36 010 0027	72, 78
274651	14-36 010 0003 14-36 010 0027	72, 78
0286 369	14-34 032 0006	78
286369	14-34 032 0006	78
0288 495	034 042 0051	51
288495	034 042 0051	51
0290 825	14-36 010 0004	72
290825	14-36 010 0004	72
0295 726	14-36 010 0005	73
295726	14-36 010 0005	73
0296 961	052 013 1050	32
296961	052 013 1050	32
0298 498	14-36 010 0021	73
298498	14-36 010 0021	73
0299 106	14-36 010 0004	72



Ref. no.	MEYLE no.	Page
DAF		
299106	14-36 010 0004	72
0303 055	034 043 0002	54
303055	034 043 0002	54
0305 049	034 042 0003	54
305049	034 042 0003	54
0307 475	034 042 0051	51
307475	034 042 0051	51
0311 049	14-34 032 0006	78
311049	14-34 032 0006	78
0311 300	036 020 0002	86
311300	036 020 0002	86
0361 477	14-34 162 0001	63
361477	14-34 162 0001	63
0366 351	14-34 032 0006 14-36 010 0013	73, 78
366351	14-34 032 0006 14-36 010 0013	73, 78
0386 930	034 026 0015	58
386930	034 026 0015	58
0490 269	050 008 1398	33
490269	050 008 1398	33
0501 182	034 042 0001	52
501182	034 042 0001	52
0505 698	12-34 126 6017	61
505698	12-34 126 6017	61
0507 808	034 042 0051	51
507808	034 042 0051	51
0513 757	14-36 035 0003	67
513 757	14-36 035 0003	67
513952	029 500 2070/S	98
0526 63R	14-36 631 0001	89
0533 891	034 042 0003	54
533891	034 042 0003	54
0538 329	14-36 010 0001	74
538329	14-36 010 0001	74
0556 289	034 650 0001	80
556289	034 650 0001	80
0558 864	14-36 010 0014	74
558864	14-36 010 0014	74
0586 753	036 020 0001	86
586753	036 020 0001	86
0587 805	034 042 0024	51
587805	034 042 0024	51
0587 808	034 042 0051	51
587808	034 042 0051	51
0589 333	034 026 0018	59

Ref. no.	MEYLE no.	Page
DAF		
589333	034 026 0018	59
0592 106	034 026 0017	58
592106	034 026 0017	58
0607 053	036 020 0005 036 020 0005/HD	84-85
607053	036 020 0005 036 020 0005/HD	84-85
0607 451	036 020 0003	84
607451	036 020 0003	84
0607 452	036 020 0008	87
607452	036 020 0008	87
0607 453	036 020 0003	84
607453	036 020 0003	84
0607 981	036 020 0004 036 020 0004/HD	85, 88
607981	036 020 0004 036 020 0004/HD	85, 88
0607 998	036 020 0002	86
607998	036 020 0002	86
0607 999	036 020 0001	86
0608 000	12-36 020 0007	83
608000	12-36 020 0007	83
0608 530	036 020 0016	83
608530	036 020 0016	83
0609 715	034 026 0026	56
609715	034 026 0026	56
0611 049	14-34 018 0012	2
611049	14-34 018 0012	2
0626 875	034 650 0001	80
626875	034 650 0001	80
0636 820	12-14 650 0005	80
636820	12-14 650 0005	80
0655 043	052 013 1475	32
655043	052 013 1475	32
0656 084	034 026 0017	58
656084	034 026 0017	58
0656 085	034 026 0018	59
656085	034 026 0018	59
0661 049	14-34 018 0012	2
661049	14-34 018 0012	2
0667 078	812 321 0001	5
667078	812 321 0001	5
0679 733	052 010 0975	32
679733	052 010 0975	32
0681 706	14-34 068 1706	63
681706	14-34 068 1706	63



Ref. no.	MEYLE no.	Page
DAF		
0683 225	14-33 220 0001	25
683225	14-33 220 0001	25
0683 579	14-33 220 0003	24
683 579	14-33 220 0003	24
0683 586	14-33 220 0001	25
683586	14-33 220 0001	25
0689 366	034 042 0062	52
689366	034 042 0062	52
0689 511	034 042 0061	53
689511	034 042 0061	53
0689 748	12-34 230 6051	68
689748	12-34 230 6051	68
0689 761	12-34 001 0009	68
689761	12-34 001 0009	68
0689 962	12-34 126 6017	61
689962	12-34 126 6017	61
0691 602	034 042 0002	53
691602	034 042 0002	53
0691 703	034 035 0028	68
691703	034 035 0028	68
0691 709	14-36 035 0003	67
691 709	14-36 035 0003	67
0692 183	034 026 0027	54
692183	034 026 0027	54
0692 380	12-34 321 0004	4
692380	12-34 321 0004	4
0693 076	14-34 321 0007	5
693076	14-34 321 0007	5
0693 096	14-34 321 0007	5
693096	14-34 321 0007	5
0693 778	034 058 0019	69
693778	034 058 0019	69
0694 277	034 042 0002	53
694277	034 042 0002	53
0694 298	036 020 0001	86
694298	036 020 0001	86
0694 360	036 020 0001	86
694360	036 020 0001	86
0695 751	034 042 0043	53
695751	034 042 0043	53
0696 205	036 020 0005 036 020 0005/HD	84-85
696205	036 020 0005 036 020 0005/HD	84-85
0696 225	036 020 0005/HD	85
696225	036 020 0005/HD	85

Ref. no.	MEYLE no.	Page
DAF		
0696 226	036 020 0004 036 020 0004/HD	85, 88
696226	036 020 0004 036 020 0004/HD	85, 88
0696 321	12-34 270 6079	69
696321	12-34 270 6079	69
0698 450	036 020 0004 036 020 0004/HD	85, 88
698450	036 020 0004 036 020 0004/HD	85, 88
0698 609	036 020 0001	86
698609	036 020 0001	86
0706 123	034 042 0001	52
706123	034 042 0001	52
0706 128	034 042 0003	54
706128	034 042 0003	54
0754 718	14-34 321 0003	6
754 718	14-34 321 0003	6
0759 050	12-34 032 0000	48
759050	12-34 032 0000	48
0763 523	14-36 010 0016	74
763523	14-36 010 0016	74
0867 636	14-34 533 0002	47
867636	14-34 533 0002	47
APUC43	14-12 321 0009	5
1142 142	12-34 042 0010	38
1142 173	12-36 020 0007	83
1152 425	050 008 1915	34
1198 153	12-34 042 0010	38
1198 154	12-34 042 0010	38
1207 748	812 321 0001	5
1224 800	14-34 232 0003	20
1224 883	14-34 234 0009	15
1224 885	14-34 234 0009	15
1228 114	036 020 0003	84
1228 115	036 020 0005 036 020 0005/HD	84-85
1229 944	036 020 0001	86
1230 594	14-34 533 0004	42
1236 096	14-34 232 0008	21
1238 561	14-34 533 0004	42
1239 411	14-36 631 0001	89
1243 049	14-34 089 0008/S	95
1249 088	034 026 0017	58
1249 129	034 026 0018	59
1252 350	12-34 126 6017	61



Ref. no.	MEYLE no.	Page
DAF		
1257 890	036 020 0004 036 020 0004/HD	85, 88
1259 622	14-34 234 0008	15
1260 954	029 600 2470	98
1261 101	14-36 050 0004	66
1263 571	14-34 232 0001	21
1265 398	052 013 1525	33
1266 426	14-34 089 0010	92
1271 385	14-34 089 0011	92
1277 475	14-34 910 0001	97
1282 146	14-34 232 0011	21
1283 618	14-34 032 0006 14-36 010 0007 14-36 010 0025	75, 78-79
1285 258	14-34 026 0003	90
1288 000	14-36 010 0018	77
1290 794	14-34 089 0003	93
1291 218	14-34 232 0005	22
1291 227	14-36 631 0001	89
1291 233	14-36 010 0017	77
1293 812	14-34 232 0007	22
1295 090	14-34 321 0001	8
1295 910	14-34 223 0001	26
1296 851	12-34 323 0008	10
1297 004	14-34 043 0001	59
1298 675	14-34 089 0005 14-34 089 0009	94, 96
1300 519	14-34 232 0004	22
1300 662	12-34 026 0002	55
1302 103	034 043 0069	56
1303 061	14-28 282 0001	25
1303 948	14-34 154 0001	59
1304 249	14-34 234 0011	15
1304 635	034 043 0073	55
1305 179	14-34 234 0011	15
1305 844	834 533 0004	48
1306 241	14-34 234 0009	15
1306 242	14-34 234 0009	15
1306 244	14-34 234 0009	15
1306 778	14-34 234 0007	16
1307 823	14-34 234 0008	15
1308 285	14-34 232 0002	23
1308 300	14-34 910 1002	97
1309 649	14-34 234 0011	15
1310 901	14-34 322 0001	3
1311 271	14-34 234 0011	15

Ref. no.	MEYLE no.	Page
DAF		
1311 608	034 009 0015	10
1314 531	14-34 321 0003	6
1314 545	14-34 032 0009 14-34 032 0010 14-34 089 0001	93, 95-96
1315 447	036 020 0002	86
1315 514	034 009 0003	11
1315 691	14-34 533 0004	42
1315 698	034 533 0017	42
1315 854	14-34 232 0004	22
1315 942	14-34 910 0100	96
1317 003	14-34 234 0011	15
1317 409	14-34 321 0008	6
1318 695	14-34 009 0002 16-34 323 0009	11-12
1318 919	14-34 321 0003	6
1319 779	14-34 234 0017	16
1319 838	036 020 0002	86
1322 255	14-12 319 0001	90
1322 259	14-12 319 0000	92
1323 838	14-36 010 0015	75
1323 839	14-36 010 0020	76
1325 345	034 043 0002	54
1326 864	036 020 0003	84
1326 866	12-36 020 0007	83
1326 896	036 020 0001	86
1328 797	14-34 234 0009	15
1330 224	14-34 234 0013	16
1330 723	14-34 234 0011	15
1330 724	14-34 234 0013	16
1331 925	036 020 0001	86
1332 181	14-34 234 0017	16
1334 257	14-34 234 0006	17
1334 259	14-34 234 0006	17
1334 261	14-34 234 0017	16
1336 529	14-34 910 0001	97
1338 714	036 020 0002	86
1338 736	14-34 232 0009	23
1341 990	12-34 032 0000	48
1345 335	14-34 018 0004	12
1346 200	14-34 910 1002	97
1346 885	14-34 321 0010	6
1348 775	14-34 234 0009	15
1349 755	14-34 234 0009	15
1349 834	14-34 234 0006	17
1349 835	14-34 234 0006	17



Ref. no.	MEYLE no.	Page
DAF		
1353 115	14-34 321 0001	8
1357 764	14-34 032 0001	64
1361 393	14-34 533 0004	42
1361 649	14-34 035 0001	67
1361 650	14-34 035 0001	67
1361 651	14-36 050 0002	65
1362 124	14-12 319 0005	90
1362 168	14-12 319 0006	91
1363 023	14-12 321 0007	8
1363 024	14-34 321 0004	8
1363 025	14-12 321 0007	8
1363 378	14-34 234 0011	15
1365 935	16-34 032 0003	49
1368 270	14-36 050 0002	65
1368 283	14-34 032 0002	64
1371 329	14-34 223 0004	28
1371 331	14-34 238 0001	29
1371 332	14-34 899 0001	28
1372 386	14-34 234 0012	14
1372 387	14-34 234 0016	17
1372 669	050 008 1915	34
1373 135	036 020 0003	84
1373 137	036 020 0008	87
1374 723	14-34 043 0001	59
1374 724	12-34 026 0002	55
1375 507	14-34 631 0004	89
1376 148	14-34 234 0007	16
1376 260	14-34 232 0006	23
1377 127	14-34 234 0013	16
1377 197	14-34 234 0013	16
1379 772	14-34 154 0001	59
1382 108	14-34 234 0015	17
1382 282	14-34 910 0101	97
1385 791	14-34 321 0010	6
1387 439	14-35 521 0003	38
1388 161	050 008 1525	34
1 389 190	12-36 020 0039	87
1390 932	14-36 050 0002	65
1391 510	14-34 042 0005	48
1393 280	050 008 2050	35
1393 344	050 008 1215	35
1393 365	050 008 1720	35
1396 202	14-34 089 0005 14-34 089 0009	94, 96
1397 382	14-34 234 0014	18
1397 764	14-34 018 0001	3

Ref. no.	MEYLE no.	Page
DAF		
1397 766	14-34 018 0002	13
1398 620	14-34 000 0001	31
1398 637	050 008 2380	36
1398 793	14-34 234 0010	18
1399 150	14-33 220 0003	24
1399 159	14-34 089 0011	92
1399 160	14-34 089 0010	92
1399 180	14-34 232 0002	23
1399 494	14-34 018 0007	3
1399 760	14-34 018 0008	13
1399 819	14-34 232 0012	24
1399 820	14-34 238 0003	29
1400 071	534 003 0001	43
1400 147	14-36 010 0019	76
1400 291	14-34 650 0002	81
1402 415	14-34 234 0018	18
1402 417	14-34 232 0010	24
1402 562	14-36 010 0028	70
1402 587	14-36 010 0023	76
1402 590	14-36 010 0022	77
1403 238	14-34 232 0011	21
1403 248	14-34 232 0010	24
1403 758	14-35 521 0006	39
1406 486	14-34 000 0002	30
1408 086	14-34 650 0002	81
1408 253	14-35 521 0006	39
1408 555	14-34 234 0018	18
1408 671	14-35 521 0006	39
1425 160	14-34 089 0006	94
1425 709	052 013 1000	33
1426 402	14-34 234 0006	17
1427 369	034 042 0033	50
1427 573	14-34 234 0004	19
1433 649	14-34 018 0016	13
1433 690	14-12 321 0009	5
1433 697	14-34 321 0006	7
1436 105	14-34 234 0006	17
1436 125	14-34 234 0006	17
1438 836	034 009 0013	10
1438 837	14-34 089 0005 14-34 089 0009	94, 96
1439 324	025 290 8730 025 290 8730/S	40-41
1439 844	14-28 282 0001	25
1441 770	14-34 234 0005	19
1441 773	14-34 234 0005	19



Ref. no.	MEYLE no.	Page
DAF		
1441 774	14-34 234 0005	19
1444 203	050 008 2120	36
1445 900	12-34 032 0000	48
1448 197	14-34 232 0002	23
1448 915	12-34 042 0010	38
1449 676	14-34 234 0005	19
1449 677	14-34 234 0005	19
1449 678	14-34 234 0001	19
1449 679	14-34 234 0001	19
1450 902	14-34 910 0101	97
1457 275	14-34 154 0001	59
1457 276	14-34 154 0002	60
1458 764	14-34 000 0001	31
1500 399	14-34 321 0001	8
1504 842	834 029 0003	61
1504 930	14-34 533 0017	43
1504 951	034 533 0017	42
1504 961	034 042 0038	50
1505 023	034 043 0005	51
1505 210	034 043 0073	55
1505 212	14-34 533 0010	44
1505 215	14-34 533 0017	43
1505 287	834 533 0004	48
1506 003	14-34 533 0001	44
1506 149	534 003 0001	43
1506 468	034 029 0026	62
1506 488	034 043 0069	56
1517 862	029 500 2070/S	98
1517 929	034 013 0006	47
1517 945	034 026 0014	61
1518 002	034 533 0031	45
1518 003	034 533 0032	45
1518 010	14-34 533 0018	46
1518 244	034 042 0016	62
1518 252	034 029 0025	62
1518 311	034 533 0035	46
1519 232	034 042 0039	50
1525 416	534 003 0001	43
1600 428	14-12 319 0004	91
1600 469	12-34 032 0000	48
1603 789	036 020 0004 036 020 0004/HD	85, 88
1604 476	034 009 0013	10
1607 794	14-34 223 0001	26
1609 853	14-33 220 0003	24
1609 871	14-33 220 0001	25

Ref. no.	MEYLE no.	Page
DAF		
1614 978	14-34 000 0001	31
1615 509	14-34 238 0001	29
1617 096	14-36 050 0002	65
1617 343	025 290 8730	40
1624 783	14-34 899 0001	28
1626 237	14-34 223 0005	26
1627 625	14-34 000 0003	30
1628 148	14-34 000 0001	31
1629 393	14-34 018 0013	4
1638 006	14-34 321 0004	8
1638 026	14-12 321 0007	8
1638 054	14-12 321 0001	7
1638 696	14-34 000 0004	31
1638 698	050 007 1750	36
1640 561	14-35 521 0003	38
1640 920	14-12 321 0007	8
1640 921	14-34 321 0004	8
1643 070	14-34 018 0013	4
1644 641	14-34 321 0006	7
1644 642	14-12 321 0009	5
1654 398	050 009 1380	37
1656 266	14-34 089 0010	92
1656 428	14-34 035 0001	67
1656 513	14-34 321 0004	8
1657 336	14-34 238 0001	29
1657 522	14-12 321 0007	8
1657 523	14-34 321 0004	8
1658 991	14-12 319 0001	90
1659 691	14-12 319 0000	92
1660 859	14-34 223 0004	28
1661 948	050 009 1380	37
1661 949	050 009 1424	37
1661 954	050 009 1424	37
1664 524	14-34 321 0001	8
1664 525	14-34 321 0001	8
1664 762	14-33 220 0002	25
1666 098	14-34 234 0004	19
1666 156	14-34 234 0005	19
1666 157	14-34 234 0005	19
1667 999	14-12 321 0009	5
1668 000	14-34 321 0006	7
1671 219	14-34 032 0003	65
1672 463	14-12 321 0009	5
1672 464	14-34 321 0006	7
1676 777	14-34 162 0001	63
1677 080	14-34 234 0003	20



Ref. no.	MEYLE no.	Page
DAF		
1680 935	14-34 234 0004	19
1680 937	14-34 234 0005	19
1680 938	14-34 234 0005	19
1683 353	034 009 0013	10
1684 655	14-34 223 0006	27
1684 900	14-28 282 0001	25
1685 352	14-34 238 0002	29
1687 821	14-34 000 0004	31
1693 441	14-34 234 0003	20
1694 953	14-34 000 0003	30
1694 967	14-34 089 0008 14-34 089 0008/S	94-95
1695 242	14-34 000 0003	30
1697 325	12-34 899 0004	1
1697 677	14-34 234 0003	20
1699 240	14-34 000 0004	31
1699 375	14-34 089 0008/S	95
1699 564	14-34 742 0001	65
1700 772	16-34 223 0001	27
1702 252	16-34 223 0001	27
1702 525	14-34 000 0002	30
1702 605	050 008 1525	34
1705 686	14-34 650 0002	81
1726 060	14-34 321 0004	8
1726 061	14-12 321 0007	8
1726 138	14-35 521 0003	38
1732 273	14-34 234 0003	20
1732 274	14-34 234 0003	20
1732 886	14-36 010 0018	77
1732 887	14-36 010 0017	77
1733 234	14-34 232 0002	23
1737 460	14-34 234 0002	20
1738 991	14-33 220 0002	25
1740 758	14-34 899 0001	28
1742 083	14-34 234 0002	20
1743 703	14-34 238 0001	29
1778 280	14-33 220 0002	25
1778 553	14-34 533 0004	42
1778 554	14-34 533 0004	42
1779 767	14-34 742 0001	65
1783 346	14-35 521 0003	38
1784 782	14-34 018 0002	13
1787556	14-34 043 0001	59
1789 292	14-12 321 0007	8
1791 192	14-12 319 0005	90
1793 875	14-36 050 0002	65

Ref. no.	MEYLE no.	Page
DAF		
1797 053	025 290 8730	40
1801 592	14-34 650 0001	79
1806 712	14-34 234 0003	20
1806 713	14-34 234 0002	20
1811 819	14-34 000 0004	31
1812 162	050 007 1750	36
1812 563	14-35 521 0003	38
1812 582	14-35 521 0003	38
1817 808	14-36 050 0002	65
1817 809	14-34 035 0001	67
1825 428	14-12 319 0000	92
1825 431	14-12 319 0006	91
1828 162	14-33 220 0002	25
1867 861	14-34 238 0001	29
1871 493	14-34 223 0004	28
1878 030	025 290 8730	40
1892 482	14-36 050 0002	65
1892 492	14-36 050 0002	65
1914 281	14-34 910 0101	97
1916 597	14-34 234 0003	20
1916 598	14-34 234 0002	20
1921 967	14-34 321 0004	8
1933 740	14-34 321 0004	8
1948 921	14-34 018 0013	4
1964 968	14-34 089 0008/S	95
1964 969	14-34 089 0008/S	95
0683 579 R	14-33 220 0003	24
683 579 R	14-33 220 0003	24
ACHD040	14-34 321 0005	9
ACHH325	14-12 321 0008	9
ACU9241	036 020 0008	87
ACU9242	036 020 0003	84
AMPA014	14-35 521 0004	39
AMPB481	14-35 521 0004	39
AMPB860	14-35 521 0004	39
AMPB887	14-35 521 0005	40
APUB185	14-34 234 0018	18
APUC331	14-34 234 0018	18
APUC944	14-34 321 0006	7
BBU5510	034 013 0006	47
BBU8177	025 290 2423	41
CBU1182	050 008 1398	33
CBU 1251	14-34 018 0009	14
CBU1532	050 008 1398	33
CBU 1716	050 008 1460	37
CBU 1920	14-34 018 0009	14



Ref. no.	MEYLE no.	Page
DAF		
FBU8648	034 042 0001	52
FBU9614	034 042 0061	53
MAK2578	14-35 521 0005	40
MAK7603	14-34 321 0009	9
NJK2785	14-35 521 0004	39
PAK3546	14-35 521 0005	40
PAK5513	14-35 521 0005	40
1 239 411R	14-36 631 0001	89
1260954G	029 600 2470	98
1643 070G	14-34 018 0013	4
1948 921G	14-34 018 0013	4
TP01020001	14-34 533 0011	46



MEYLE – premium quality

for vehicle classes from S to XXL



Whether passenger car, van or commercial vehicle parts – MEYLE is always a smart choice. Because products of the MEYLE brand stand for outstanding quality and enhanced performance. From production to delivery MEYLE spare parts are subjected to subsequent multi-stage testing to ensure our products meet the stringent quality standards of a German manufacturer.

Notes

This catalogue is protected by copyright. Reproduction of text, graphic elements, photographs and/or data, even in part, is prohibited. MEYLE, , or parts thereof, are registered trademarks of Wulf Gaertner Autoparts AG.

All supplies and services are subject to our General Terms and Conditions. The original spare part numbers shown in this catalogue are for cross-reference purposes only and shall not be disclosed to third parties on invoices and delivery notes. While the information in this catalogue was compiled and edited with utmost care we do not assume responsibility or accept claims arising from errors or inconsistencies. Subject to technical and/or design changes.

This issue of the catalogue supersedes all previous issues.
All rights reserved. © 2015 Wulf Gaertner Autoparts AG



Simply lasts longer.