



**MEYLE**<sup>®</sup>  
Products



# Spare Parts

for trucks



MAN

## **1 Engine/Cooling**

Belt drive / Engine control • Cooling system • Crankshaft drive  
Cylinder head • Engine • Exhaust system • Fuel system  
Lubrication system • Mounts

## **2 Brakes**

Air system • Brakes • Disc brake • Drum brake • Mounting parts

## **3 Drive train/Transmission/Clutch**

Axle shafts • Clutch • Transmission

## **4 Suspension**

Control arms • Stabilizer • Stub axle • Suspension / damping  
Wheel hubs / Wheel bearings

## **5 Steering**

Hydraulics • Mounting parts • Tie rod assemblies

## **6 Body/Cabin**

Body • Cabin • Interior fittings • Interiors • Lighting

## **7 Auxiliary parts / Miscellaneous**

Universal parts

Index **MEYLE no.** → **Ref. no.**

Index **Ref. no.** → **MEYLE no.**

## Engine/Cooling

**1**
**Belt drive / Engine control, Cooling system, Crankshaft drive, Cylinder head, Engine, Exhaust system, Fuel system, Lubrication system, Mounts**

Air filter	Full gasket set, engine	Rocker bush
Belt tensioner	Gasket set, cylinder head	Sender, oil pressure
Crank position sensor	Gasket, oil pan	Sensor, boost pressure
Crankshaft seal	Hand primer pump	Sensor, coolant level
Engine mount	Intake air, temperature sensor	Sensor, RPM
Expansion tank	Oil cooler	Tension roller, ribbed belt
Expansion tank cap	Oil filter	Thermostat
Fan blade	Radiator cap	Valve cover gasket
Fan clutch	Radiator fan motor	V-belt
Flex hose, exhaust system	Radiator hose	Voltage regulator
Fuel filter	Ring gear, crankshaft	V-ribbed belt
Fuel pump	Rocker arm, valve train	Water pump

## Brakes

**92**
**Air system, Brakes, Disc brake, Drum brake, Mounting parts**

ABS wheel sensor	Cylinder liner, compressor	Repair kit, brake caliper
Air dryer cartridge	Diaphragm, brake cylinder	Repair kit, brake shoe sleeve
Air suspension valve	Line filter, compressor system	Sensor, pneumatic suspension level
Brake disc	Multi-circuit protection valve	Silencer, compressor system
Brake line coupling	Multiway valve	Slave cylinder
Brake pad set	Overflow valve	Valve plate, air compressor
Brake valve, park brake	Pressure limiting valve	Valve, compressor system
Check valve	Quick release valve	Wear sensor
Control valve, trailer	Relay valve	
Cylinder head, compressor	Repair kit, brake adjuster	

## Drive train/Transmission/Clutch

**134**
**Axle shafts, Clutch, Transmission**

Bolt, release fork	Joint, propeller shaft	Repair kit, clutch releaser
Clutch booster	Neutral safety switch	Shaft seal, differential
Clutch master cylinder	Release bearing	Shift rod connector
Drive shaft support	Release fork, clutch	Switch, splitter gearbox

## Suspension

**148**
**Control arms, Stabilizer, Stub axle, Suspension / damping, Wheel hubs / Wheel bearings**

Bushing, leaf spring	Mount, stabilizer	Shaft seal, wheel hub
Bushing, stabilizer	Repair kit, control arm	Wheel bearing
Control arm	Repair kit, kingpin	Wheel nut
Gasket set, planetary gear box	Ring, wheel hub	
Mount, leaf spring	Rod/strut, suspension	

## Steering

**186**
**Hydraulics, Mounting parts, Tie rod assemblies**

Drag link	Hydraulic pump, P/S	Tie rod assembly
Hydraulic filter, steering system	P/S fluid reservoir	Tie rod end

## Body/Cabin

**202**
**Body, Cabin, Interior fittings, Interiors, Lighting**

Bushing, driver cab suspension	Door lock	Latch, driver cabine
Cabin air filter	Gas spring, front hood	Lock cylinder set
Column switch	Gear shift knob	Repair kit, driver cab mounting
Door handle	Hinge, driver cab	Rubber stop, cabin



Seal, driver cab stabiliser  
Side marker  
Spacer, driver cab stabiliser

Tilt cylinder, driver cab  
Tilt pump, driver cab  
Window lifter

Windshield washer pump  
Wiper Blade

---

## Auxiliary parts / Miscellaneous

225

### Universal parts

Multifunction relay

**12-34 100 6558**  
 51.00900.6536

**Gasket set, cylinder head**
**Notes**

 with valve stem seals  
 with rocker cover gasket  
 with cylinder head gasket  
 Steel Elastomer

**References**

 51.00900.6536  
 51.00900.6552

51.00900.6558

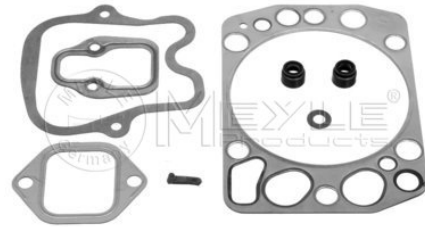
**Application info**

 EL (01/93-06/97)  
 F 2000 (01/94-12/95)  
 F 90 (07/86-12/97)  
 F 90 Unterflur (07/86-05/94)  
 LION'S COACH (09/95--)  
 LION'S COMFORT (09/96--)  
 LION'S STAR (01/93-09/96)  
 M 90 (08/88-06/96)  
 NG (--07/98)

 NL (--07/98)  
 NÜ (09/96-07/98)  
 R (05/85-01/93)  
 SG (07/76-06/97)  
 SL (05/80-04/87)  
 SL II (--04/94)  
 SÜ (--06/97)  
 ÜL (09/89-09/96)

**Gasket set, cylinder head**
**12-34 900 6437**  
 51.00900.6570

**Notes**

 with valve stem seals  
 with rocker cover gasket  
 with cylinder head gasket  
 Steel Elastomer

**References**

 51.00900.6273  
 51.00900.6437

51.00900.6570

**Application info**

 SD (04/74-04/94)  
 SG (07/76-06/97)  
 SL (05/80-04/87)

 SR (10/75-11/86)  
 SÜ (--06/97)



1

**12-34 900 0002**  
51.00900.6628

**Gasket set, cylinder head**

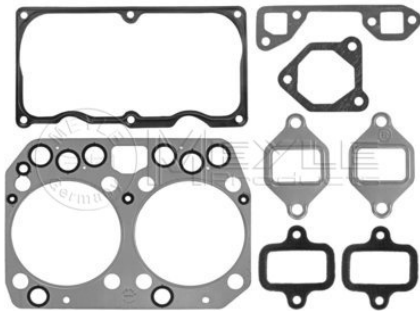

**Notes**

with cylinder head gasket  
Steel Elastomer

**References**

51.00900.6628

51.00900.6650

**Application info**

CLA (01/06--)  
L 2000 (10/93-07/97)

M 2000 L (08/95--)  
M 2000 M (--12/05)

**12-34 900 0000**  
51.00900.6630

**Gasket set, cylinder head**

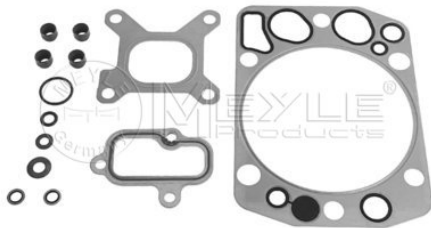

**Notes**

with valve stem seals  
with rocker cover gasket  
with cylinder head gasket  
Steel Elastomer

**References**

51.00900.6630

**Application info**

F 2000 (01/94-12/95)  
LION'S COACH (09/95--)  
LION'S STAR (01/93-09/96)

SÜ (--06/97)  
TGA (04/00--)

**12-34 900 0001**  
51.00900.6639

**Gasket set, cylinder head**

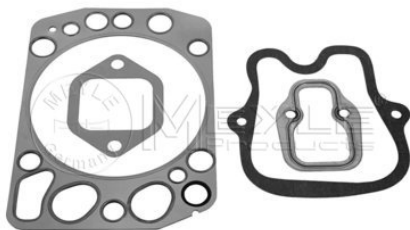

**Notes**

without valve stem seals  
with rocker cover gasket  
with cylinder head gasket  
Steel Elastomer

**References**

51.00900.6629

51.00900.6639



**Gasket set, cylinder head**
**12-34 900 0001**  
 51.00900.6639

**Application info**

 E 2000 (05/00--)  
 F 2000 (01/94-12/95)  
 F 90 (07/86-12/97)

 F 90 Unterflur (07/86-05/94)  
 TGA (04/00--)  
 ÜL (09/89-09/96)

**Valve cover gasket**
**12-34 905 0135**  
 51.03905.0135

**Notes**

 Thickness [mm] Paper  
 2

**References**

51.03905.0091	51.03905.0105
51.03905.0094	51.03905.0109
51.03905.0098	51.03905.0123
51.03905.0103	51.03905.0134
51.03905.0104	51.03905.0135

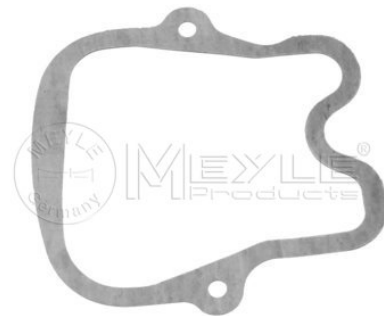
**Application info**

 F 2000 (01/94-12/95)  
 F 90 (07/86-12/97)

 F 90 Unterflur (07/86-05/94)  
 M 90 (08/88-06/96)

**Valve cover gasket**
**12-34 905 0001**  
 51.03905.0157

**Notes**

Thickness [mm] 1.55

**References**

51.03905.0157

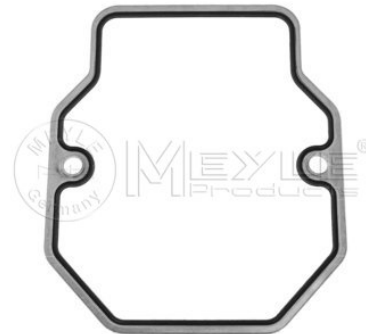
**Application info**

 F 2000 (01/94-12/95)  
 LION'S COACH (09/95--)  
 LION'S COMFORT (09/96--)  
 LION'S STAR (01/93-09/96)  
 NG (--07/98)

 NL (--07/98)  
 NÜ (09/96-07/98)  
 SÜ (--06/97)  
 TGA (04/00--)  
 ÜL (09/89-09/96)



1

**12-34 905 0002**  
51.03905.0161

**Valve cover gasket**



**Notes**

Thickness [mm] 1.5

**References**

51.03905.0161

**Application info**

F 2000 (01/94-12/95)  
LION'S COACH (09/95--)

LION'S STAR (01/93-09/96)  
TGA (04/00--)

**12-34 040 0001**  
51.00900.6604

**Full gasket set, engine**



**References**

51.00900.6531 51.00900.6604

**Application info**

G 90 (09/87-05/95)

**034 005 1015**  
51.04202.5034

**Rocker bush**



**References**

51.04202.5034

+



**Rocker bush**
**034 005 1015**  
 51.04202.5034

**Application info**

 F 2000 (01/94-12/95)  
 F 90 (07/86-12/97)  
 F 90 Unterflur (07/86-05/94)  
 LION'S COMFORT (09/96--)

 M 90 (08/88-06/96)  
 NÜ (09/96-07/98)  
 SÜ (-06/97)  
 ÜL (09/89-09/96)

**Rocker arm, valve train**
**034 005 1004**  
 51.04201.6111

**References**

51.04201.6111

**Application info**

 F 2000 (01/94-12/95)  
 F 90 (07/86-12/97)  
 F 90 Unterflur (07/86-05/94)

 LION'S COMFORT (09/96--)  
 M 90 (08/88-06/96)

**Ring gear, crankshaft**
**12-34 130 0032**  
 51.02130.0012

**Notes**

Inner Diameter [mm]	99.5
Outer Diameter [mm]	105
Height [mm]	17.8
	Front

**References**

51.02130.0005	51.02130.0012
51.02130.0007	51.02130.0032
51.02130.0008	

**Application info**

 F 2000 (01/94-12/95)  
 F 90 (07/86-12/97)  
 F 90 Unterflur (07/86-05/94)  
 LION'S COMFORT (09/96--)  
 LION'S STAR (01/93-09/96)

 M 90 (08/88-06/96)  
 NÜ (09/96-07/98)  
 SÜ (-06/97)  
 ÜL (09/89-09/96)



1

**034 003 1024**  
51.02130.0013

**Ring gear, crankshaft**



**Notes**

Inner Diameter [mm]	115
Outer Diameter [mm]	120
Height [mm]	21
	Front

**References**

51.02130.0013	51.93020.0236
---------------	---------------

**Application info**

F 2000 (01/94-12/95)

F 90 (07/86-12/97)

**034 035 0038**  
51.01510.0150

**Crankshaft seal**



**Notes**

Inner Diameter [mm]	Right-hand Twist
Outer Diameter [mm]	105
Height [mm]	130
	12
	Timing End

**References**

51.01510.0150
---------------

**Application info**

F 90 Unterflur (07/86-05/94)

**12-34 099 0004**  
51.01510.0206

**Crankshaft seal**



**Notes**

Inner Diameter [mm]	Left-hand Twist
Outer Diameter [mm]	120
Height [mm]	140
	12
	Transmission End

**References**

51.01510.0133	51.01510.0196
51.01510.0134	51.01510.0206
51.01510.0140	51.01510.0207
51.01510.0141	51.01510.0208
51.01510.0184	



**12-34 099 0004**  
 51.01510.0206

**Crankshaft seal**
**Application info**

F 2000 (01/94-12/95)	SG (07/76-06/97)
F 90 (07/86-12/97)	SL (05/80-04/87)
F 90 Unterflur (07/86-05/94)	SL II (--04/94)
LION'S COACH (09/95--)	SR (10/75-11/86)
LION'S STAR (01/93-09/96)	SÜ (--06/97)
M 90 (08/88-06/96)	ÜL (09/89-09/96)
SD (04/74-04/94)	

**12-34 099 0005**  
 51.01510.0218

**Crankshaft seal**
**Notes**

	Left-hand Twist
Inner Diameter [mm]	110
Outer Diameter [mm]	130
Height [mm]	13
	Timing End

**References**

51.01510.0151	51.01510.0218
---------------	---------------

**Application info**

EL (01/93-06/97)	NL (--07/98)
EM (08/87-06/97)	NM (--03/97)
G (10/79-08/88)	NÜ (09/96-07/98)
G 90 (09/87-05/95)	SM (11/87-02/95)
L 2000 (10/93-07/97)	SÜ (--06/97)
M 2000 L (08/95--)	TGA (04/00--)
M 2000 M (--12/05)	TGL (04/05--)
M 90 (08/88-06/96)	TGM (10/05--)
NG (--07/98)	

**12-34 099 0003**  
 51.01510.0219

**Crankshaft seal**
**Notes**

	Right-hand Twist
Inner Diameter [mm]	66
Outer Diameter [mm]	90
Height [mm]	12
	Timing End

**References**

51.01510.0172	51.01510.0219
51.01510.0174	51.01510.0237
51.01510.0179	51.01510.7000





1

**12-34 099 0003**  
51.01510.0219

**Crankshaft seal**

**Application info**

EL (01/93-06/97)  
EM (08/87-06/97)  
G 90 (09/87-05/95)  
L 2000 (10/93-07/97)  
M 2000 L (08/95--)  
M 2000 M (--12/05)  
M 90 (08/88-06/96)

NG (--07/98)  
NL (--07/98)  
NM (--03/97)  
SÜ (--06/97)  
TGA (04/00--)  
TGL (04/05--)  
TGM (10/05--)

**12-34 099 0007**  
51.01510.0273

**Crankshaft seal**



**Notes**

Inner Diameter [mm]  
Outer Diameter [mm]  
Height [mm]

Right-hand Twist  
100  
130  
12  
Timing End

**References**

51.01510.0236	51.01510.6005
51.01510.0273	51.01510.6008
51.01510.0282	

**Application info**

TGA (04/00--)  
TGS (09/07--)

TGX (09/07--)

**12-34 099 0006**  
51.01510.6004

**Crankshaft seal**



**Notes**

Inner Diameter [mm]  
Outer Diameter [mm]  
Height [mm]

Right-hand Twist  
105  
130  
12  
Transmission End

**References**

51.01510.0197	51.01510.6004
51.01510.0199	51.01510.6006
51.01510.0226	51.01510.6007
51.01510.6003	

**Application info**

E 2000 (05/00--)  
EL (01/93-06/97)  
F 2000 (01/94-12/95)  
F 90 (07/86-12/97)  
F 90 Unterflur (07/86-05/94)  
M 90 (08/88-06/96)  
NG (--07/98)  
NL (--07/98)

NÜ (09/96-07/98)  
R (05/85-01/93)  
SD (04/74-04/94)  
SG (07/76-06/97)  
SÜ (--06/97)  
TGA (04/00--)  
ÜL (09/89-09/96)

**12-34 003 0001**  
 51.27120.0008

**Sensor, RPM**
**Notes**

	Passive sensor
Cable Length [mm]	370
Number of Poles	2
Resistance [Ohm]	950

**References**

51.27120.0005	51.27120.0011
51.27120.0008	

**Application info**

EL (01/93-06/97)	M 90 (08/88-06/96)
EM (08/87-06/97)	NG (--07/98)
F 2000 (01/94-12/95)	NL (--07/98)
F 90 (07/86-12/97)	NM (--03/97)
F 90 Unterflur (07/86-05/94)	NÜ (09/96-07/98)
L 2000 (10/93-07/97)	SG (07/76-06/97)
LION'S COACH (09/95--)	SÜ (--06/97)
LION'S COMFORT (09/96--)	TGA (04/00--)
LION'S STAR (01/93-09/96)	TGS (09/07--)
M 2000 L (08/95--)	TGX (09/07--)
M 2000 M (--12/05)	ÜL (09/89-09/96)

**Sensor, RPM**
**12-34 003 0002**  
 51.27120.0009

**Notes**

	Passive sensor
Cable Length [mm]	420
Number of Poles	2
Resistance [Ohm]	950

**References**

51.27120.0006	51.27120.0012
51.27120.0009	

**Application info**

EL (01/93-06/97)	NG (--07/98)
EM (08/87-06/97)	NL (--07/98)
F 2000 (01/94-12/95)	NM (--03/97)
F 90 (07/86-12/97)	NÜ (09/96-07/98)
F 90 Unterflur (07/86-05/94)	SG (07/76-06/97)
L 2000 (10/93-07/97)	SÜ (--06/97)
LION'S COACH (09/95--)	TGA (04/00--)
LION'S STAR (01/93-09/96)	TGS (09/07--)
M 2000 L (08/95--)	TGX (09/07--)
M 2000 M (--12/05)	ÜL (09/89-09/96)
M 90 (08/88-06/96)	



1

**12-34 003 0009**  
51.27120.0014

**Sensor, RPM**

**Notes**

Cable Length [mm]  
Number of Poles  
Resistance [Ohm]

Passive sensor  
780  
2  
1150

**References**

51.27120.0014

**Application info**

E 2000 (05/00--)  
F 2000 (01/94-12/95)  
TGA (04/00--)

TGL (04/05--)  
TGM (10/05--)

**12-34 003 0010**  
51.27120.0015

**Sensor, RPM**



**Notes**

Cable Length [mm]  
Number of Poles

Inductive Sensor  
905  
2

**References**

51.27120.0015

**Application info**

E 2000 (05/00--)  
F 2000 (01/94-12/95)  
TGA (04/00--)

TGL (04/05--)  
TGM (10/05--)

**034 015 0005**  
81.25601.6024

**Voltage regulator**



**Notes**

Voltage [V]

28

**References**

81.25601.6024



## Voltage regulator

**034 015 0005**  
 81.25601.6024

### Application info

F 90 (07/86-12/97)

F 90 Unterflur (07/86-05/94)

G 90 (09/87-05/95)

## Crank position sensor

**12-34 003 0011**  
 51.27120.7038

### Notes

	Inductive Sensor
Operating voltage [V]	12
Number of Poles	2
	with seal
	without cable
Resistance [Ohm]	950

### References

51.27120.0016

51.27120.7035

51.27120.7037

51.27120.7038



### Application info

TGA (04/00--)

TGL (04/05--)

TGM (10/05--)

TGS (09/07--)

TGX (09/07--)

## Sender, oil pressure

**12-14 820 0000**  
 81.27421.0109

### Notes

	Active sensor
Spanner Size	22
Thread Size	M18x1,5
Operating voltage [V]	24
Number of Poles	3

### References

81.27421.0098

81.27421.0109

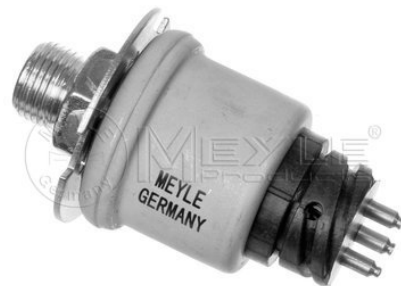

### Application info

F 2000 (01/94-12/95)

F 90 (07/86-12/97)

F 90 Unterflur (07/86-05/94)

LION'S COMFORT (09/96--)

LION'S STAR (01/93-09/96)

M 90 (08/88-06/96)

NÜ (09/96-07/98)

SÜ (-06/97)

ÜL (09/89-09/96)



1

**12-34 899 0022**  
51.27421.0077

**Intake air, temperature sensor**



**Notes**

Operating voltage [V]	Active sensor 24
Number of Poles	2

**References**

51.27421.0077

**Application info**

E 2000 (05/00--)  
F 2000 (01/94-12/95)  
F 90 (07/86-12/97)  
G 90 (09/87-05/95)  
L 2000 (10/93-07/97)  
M 2000 L (08/95--)

M 2000 M (--12/05)  
M 90 (08/88-06/96)  
SG (07/76-06/97)  
SM (11/87-02/95)  
SÜ (--06/97)  
TGA (04/00--)

**12-34 899 0004**  
51.27421.0216

**Sensor, boost pressure**

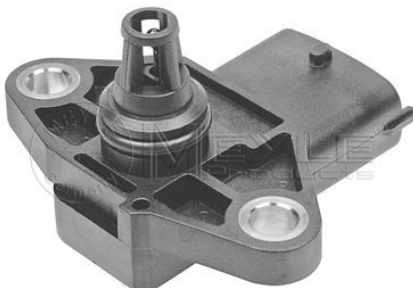

**Notes**

Operating voltage [V]	Piezoelectric Sensor 24
Number of Poles	4

**References**

51.27421.0198                      51.27421.0216

**Application info**

LION'S COACH (09/95--)  
LION'S STAR (01/93-09/96)  
TGA (04/00--)  
TGL (04/05--)

TGM (10/05--)  
TGS (09/07--)  
TGX (09/07--)

**12-34 904 0132**  
51.05904.0132

**Gasket, oil pan**



**References**

51.05904.0132





**12-34 904 0132**  
 51.05904.0132

**Gasket, oil pan**
**Application info**

F 90 (07/86-12/97)	SG (07/76-06/97)
F 90 Unterflur (07/86-05/94)	SL (05/80-04/87)
LION'S COACH (09/95--)	SL II (--04/94)
LION'S STAR (01/93-09/96)	SR (10/75-11/86)
R (05/85-01/93)	SÜ (--06/97)
SD (04/74-04/94)	ÜL (09/89-09/96)

**Oil filter**
**014 018 0015**  
 51.05500.6073

**Notes**

	with gaskets/seals
Inner Diameter [mm]	36.5
Outer Diameter [mm]	82
Height [mm]	174
	Filter Insert

**References**

51.05500.6073	51.05504.0105
---------------	---------------

**Application info**

TGA (04/00--)	TGM (10/05--)
TGL (04/05--)	

**Oil filter**
**12-14 322 0003**  
 51.05501.7160

**Notes**

	with seal
Inner Diameter [mm]	91
Outer Diameter [mm]	109
Height [mm]	180
Thread Size	M30x2
	Screw-on Filter

**References**

51.05501.7160	51.05501.7166
51.05501.7161	51.05501.7180
51.05501.7163	

**Application info**

CLA (01/06--)	M 90 (08/88-06/96)
EL (01/93-06/97)	NG (--07/98)
EM (08/87-06/97)	NL (--07/98)
G 90 (09/87-05/95)	NM (--03/97)
L 2000 (10/93-07/97)	NÜ (09/96-07/98)
M 2000 L (08/95--)	SM (11/87-02/95)
M 2000 M (--12/05)	SÜ (--06/97)



1

**014 018 0009**  
51.05504.0048

**Oil filter**



**Notes**

	with gaskets/seals
Inner Diameter [mm]	56
Inner Diameter [mm]	15
Outer Diameter [mm]	120
Height [mm]	165
	Filter Insert

**References**

51.05504.0048	51.05504.0086
51.05504.0049	51.05504.0091
51.05504.0068	81.00000.0239
51.05504.0084	81.05504.0038
51.05504.0085	81.05504.0040

**Application info**

F 9 (01/83-12/86)  
F 90 (07/86-12/97)

NL (-07/98)

**12-14 322 0001**  
51.05504.0096

**Oil filter**



**Notes**

	with seal
Inner Diameter 2 [mm]	36
Inner Diameter 1 [mm]	28
Outer Diameter [mm]	83
Height [mm]	214
	Filter Insert

**References**

51.05504.0096	82.05504.6096
---------------	---------------

**Application info**

E 2000 (05/00--)  
F 2000 (01/94-12/95)  
F 90 (07/86-12/97)

TGA (04/00--)  
TGL (04/05--)  
TGM (10/05--)

**12-14 322 0000**  
51.05504.0098

**Oil filter**



**Notes**

	with seal
Inner Diameter [mm]	55
Outer Diameter [mm]	120
Height [mm]	148
	Filter Insert

**References**

51.05504.0098	81.05504.0025
---------------	---------------

+

**12-14 322 0000**  
 51.05504.0098

**Oil filter**
**Application info**

E 2000 (05/00--)	SG (07/76-06/97)
F 2000 (01/94-12/95)	SL (05/80-04/87)
LION'S COACH (09/95--)	SÜ (--06/97)
LION'S STAR (01/93-09/96)	TGA (04/00--)

**12-14 322 0004**  
 51.05504.0107

**Oil filter**
**Notes**

	with seal
Inner Diameter 2 [mm]	57
Inner Diameter 1 [mm]	15
Outer Diameter [mm]	121
Height [mm]	204
	Filter Insert

**References**

51.05504.0107	51.05504.0122
51.05504.0108	

**Application info**

HOCL (01/85-05/09)	SÜ (--06/97)
NG (--07/98)	TGA (04/00--)
NL (--07/98)	TGS (09/07--)
SL (05/80-04/87)	TGX (09/07--)

**Oil cooler**
**034 018 1002**  
 51.05601.0148

**Notes**

	Manual Transmission
Height [mm]	63
Width [mm]	78
Number of Ribs	10
Length [mm]	250

**References**

51.05601.0148

**Application info**

F 2000 (01/94-12/95)	TGA (04/00--)
----------------------	---------------



1

**12-34 321 0010**  
81.08304.0043

**Air filter**



**Notes**

Inner Diameter [mm]	191
Inner Diameter [mm]	11
Outer Diameter [mm]	302
Height [mm]	473
	Filter Insert

**References**

81.08304.0038	81.08304.0091
81.08304.0043	81.08401.6213
81.08304.0044	

**Application info**

F 90 (07/86-12/97)  
F 90 Unterflur (07/86-05/94)  
LION'S COACH (09/95--)  
LION'S STAR (01/93-09/96)  
M 2000 L (08/95--)

M 90 (08/88-06/96)  
SG (07/76-06/97)  
SR (10/75-11/86)  
ÜL (09/89-09/96)

**16-34 321 0010**  
81.08304.0051

**Air filter**

**Notes**

Inner Diameter [mm]	170
Inner Diameter [mm]	17
Outer Diameter [mm]	281
Height [mm]	420
	Filter Insert

**References**

81.08304.0051

**Application info**

SD (04/74-04/94)

**012 094 0024**  
81.08304.0055

**Air filter**



**Notes**

Inner Diameter [mm]	103
Outer Diameter [mm]	198
Height [mm]	365
	Filter Insert

**References**

81.08304.0049	81.08304.0056
81.08304.0055	



**Air filter**
**012 094 0024**  
 81.08304.0055

**Application info**

 G 90 (09/87-05/95)  
 L 2000 (10/93-07/97)  
 M 2000 L (08/95--)

 M 90 (08/88-06/96)  
 NM (--03/97)  
 SM (11/87-02/95)

**Air filter**
**12-34 321 0011**  
 81.08304.0076

**Notes**

Inner Diameter [mm]	132
Inner Diameter [mm]	10.5
Outer Diameter [mm]	242
Height [mm]	378
	Filter Insert

**References**

81.08304.0074	81.08304.0076
---------------	---------------

**Application info**

 CLA (01/06--)  
 EL (01/93-06/97)  
 EM (08/87-06/97)  
 M 2000 L (08/95--)  
 M 2000 M (--12/05)

 M 90 (08/88-06/96)  
 NG (--07/98)  
 NL (--07/98)  
 NM (--03/97)  
 SÜ (--06/97)

**Air filter**
**12-34 321 0002**  
 81.08304.0084

**Notes**

Inner Diameter [mm]	134
Outer Diameter [mm]	162
Height [mm]	468
	Filter Insert

**References**

81.08304.0084

**Application info**

 E 2000 (05/00--)  
 F 2000 (01/94-12/95)

F 90 (07/86-12/97)



1

**12-34 321 0004**  
81.08304.0085

**Air filter**



**Notes**

Inner Diameter [mm]	93
Inner Diameter [mm]	17
Outer Diameter [mm]	111
Height [mm]	372
	Filter Insert

**References**

81.08304.0085	81.08405.0012
---------------	---------------

**Application info**

L 2000 (10/93-07/97)

M 2000 L (08/95--)

**812 321 0001**  
81.08304.0086

**Air filter**



**Notes**

Inner Diameter [mm]	190.5
Outer Diameter [mm]	302
Height [mm]	365
	Filter Insert

**References**

81.08304.0086
---------------

**Application info**

EL (01/93-06/97)  
NG (--07/98)

NL (--07/98)  
ÜL (09/89-09/96)

**12-34 321 0014**  
81.08304.0093

**Air filter**



**Notes**

Inner Diameter [mm]	119
Outer Diameter [mm]	249
Height [mm]	500
	Filter Insert

**References**

81.08304.0093
---------------

**Application info**

NG (--07/98)  
NL (--07/98)

NÜ (09/96-07/98)  
SÜ (--06/97)

**Air filter**
**034 321 0009**  
 81.08304.0100

**Notes**

Inner Diameter [mm]	170
Outer Diameter [mm]	265
Height [mm]	481
	Filter Insert

**References**

81.08304.0100

**Application info**

TGA (04/00-)

**Air filter**
**12-34 321 0019**  
 81.08304.0101

**Notes**

Inner Diameter [mm]	150
Outer Diameter [mm]	248
Height [mm]	414.5
	Filter Insert

**References**

81.08304.0101	81.08304.0103
---------------	---------------

**Application info**

LION'S CITY (08/04-)

NM (-03/97)

**Air filter**
**12-34 321 0008**  
 81.08405.0008

**Notes**

Outer Diameter [mm]	121
Height [mm]	379
Length [mm]	105
	Filter Insert

**References**

81.08304.0046	81.08405.0008
---------------	---------------

**Application info**

F 90 (07/86-12/97)

M 90 (08/88-06/96)



1

**12-34 321 0006**  
81.08405.0015

**Air filter**



**Notes**

Inner Diameter [mm]	119
Outer Diameter [mm]	248
Height [mm]	382
	Filter Insert

**References**

81.08304.0087	81.08405.0015
---------------	---------------

**Application info**

L 2000 (10/93-07/97)	M 2000 M (--12/05)
M 2000 L (08/95--)	

**12-34 321 0005**  
81.08405.0017

**Air filter**

**Notes**

Inner Diameter [mm]	137
Outer Diameter [mm]	155.5
Height [mm]	455
	Filter Insert

**References**

81.08405.0017

**Application info**

TGA (04/00--)	TGX (09/07--)
TGS (09/07--)	

**12-34 321 0009**  
81.08405.0018

**Air filter**



**Notes**

Inner Diameter [mm]	125
Outer Diameter [mm]	250
Height [mm]	460
	Filter Insert

**References**

81.08405.0018

**Application info**

TGL (04/05--)	TGM (10/05--)
---------------	---------------



**Air filter**
**12-34 321 0003**

81.08405.0021

**Notes**

Inner Diameter [mm]	170
Outer Diameter [mm]	266
Height [mm]	510
	Filter Insert

**References**

81.08405.0016	81.08405.0021
81.08405.0020	

**Application info**

 LION'S COACH (09/95--)  
 TGA (04/00--)

 TGS (09/07--)  
 TGX (09/07--)

**Air filter**
**12-34 321 0017**

81.08405.0022

**Notes**

Inner Diameter [mm]	150
Outer Diameter [mm]	232
Height [mm]	415
	Filter Insert

**References**

81.08405.0022

**Application info**

TGL (04/05--)

TGM (10/05--)

**Air filter**
**12-34 321 0018**

81.08405.0023

**Notes**

Inner Diameter [mm]	130
Outer Diameter [mm]	227
Height [mm]	305
	Filter Insert

**References**

81.08405.0023

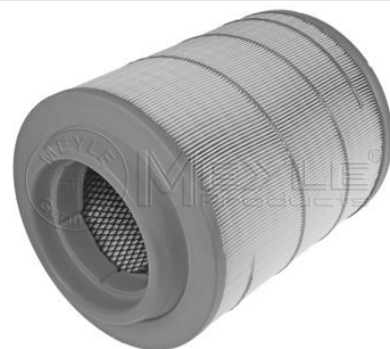
**Application info**

TGL (04/05--)

TGM (10/05--)



1

**12-34 321 0021**  
81.08405.0029

**Air filter**



**Notes**

Inner Diameter [mm]	170
Outer Diameter [mm]	251
Height [mm]	533
	Filter Insert

**References**

81.08405.0029

**Application info**

LION'S CITY (08/04--)  
NG (--07/98)

NL (--07/98)

**12-34 321 0022**  
81.08405.0030

**Air filter**



**Notes**

Inner Diameter [mm]	199
Outer Diameter [mm]	281
Height [mm]	564
	Filter Insert

**References**

81.08405.0030

**Application info**

HOCL (01/85-05/09)  
SL II (--04/94)

SÜ (--06/97)

**12-34 009 0003**  
51.12101.7120

**Fuel pump**



**Notes**

Manual

**References**

51.12101.7045	51.12101.7128
51.12101.7046	51.12101.7137
51.12101.7120	







1

**12-14 323 0002**  
51.12503.0042

**Fuel filter**



**Notes**

Outer Diameter [mm]	76
Height [mm]	230
	Filter Insert

**References**

51.12503.0037	51.12503.0056
51.12503.0042	82.12503.0042

**Application info**

F 2000 (01/94-12/95)  
LION'S COACH (09/95--)  
LION'S STAR (01/93-09/96)

SÜ (--06/97)  
TGA (04/00--)

**12-34 323 0012**  
51.12503.0048

**Fuel filter**



**Notes**

Outer Diameter [mm]	76
Height [mm]	230
	Filter Insert

**References**

51.12503.0048

**Application info**

TGA (04/00--)

**12-34 323 0001**  
51.12503.0059

**Fuel filter**



**Notes**

	Steel
Outer Diameter [mm]	76.5
Height [mm]	157
Port Thread	M16x1,5
	Screw-on Filter

**References**

51.12503.0059	51.12503.0060
---------------	---------------



**12-34 323 0001**  
 51.12503.0059

**Fuel filter**
**Application info**

EL (01/93-06/97)	NG (--07/98)
EM (08/87-06/97)	NL (--07/98)
L 2000 (10/93-07/97)	NM (--03/97)
LION'S STAR (01/93-09/96)	NÜ (09/96-07/98)
M 2000 L (08/95--)	SM (11/87-02/95)
M 2000 M (--12/05)	SÜ (--06/97)
M 90 (08/88-06/96)	ÜL (09/89-09/96)

**12-34 323 0009**  
 51.12503.0062

**Fuel filter**
**Notes**

Outer Diameter [mm]	50
Height [mm]	41
	Filter Insert

**References**

51.12503.0047	51.12503.0062
---------------	---------------

**Application info**

L 2000 (10/93-07/97)	TGL (04/05--)
M 2000 L (08/95--)	TGM (10/05--)
M 2000 M (--12/05)	TGX (09/07--)
TGA (04/00--)	

**12-34 323 0007**  
 51.12503.0063

**Fuel filter**
**Notes**

Diameter [mm]	46
Diameter [mm]	14
Outer Diameter [mm]	95
Height [mm]	174
	Filter Insert

**References**

51.12503.0061	51.12503.0063
---------------	---------------

**Application info**

TGA (04/00--)	TGS (09/07--)
TGL (04/05--)	TGX (09/07--)
TGM (10/05--)	



1

**014 323 0008**  
51.12503.6000

**Fuel filter**



**Notes**

Diameter [mm]	110
Height [mm]	220
Thread Size	1-1/4"-UNS-2B
	Screw-on Filter

**References**

51.12503.0051	51.12503.6000
---------------	---------------

**Application info**

EL (01/93-06/97)  
EM (08/87-06/97)  
F 2000 (01/94-12/95)  
F 90 (07/86-12/97)  
F 90 Unterflur (07/86-05/94)  
G (10/79-08/88)  
G 90 (09/87-05/95)  
L 2000 (10/93-07/97)  
LION'S COACH (09/95--)  
LION'S COMFORT (09/96--)  
LION'S STAR (01/93-09/96)  
M 2000 L (08/95--)  
M 2000 M (--12/05)  
M 90 (08/88-06/96)  
NG (--07/98)  
NL (--07/98)

NM (--03/97)  
NÜ (09/96-07/98)  
R (05/85-01/93)  
SD (04/74-04/94)  
SG (07/76-06/97)  
SL (05/80-04/87)  
SL II (--04/94)  
SM (11/87-02/95)  
SR (10/75-11/86)  
SÜ (--06/97)  
TGA (04/00--)  
TGL (04/05--)  
TGM (10/05--)  
TGS (09/07--)  
TGX (09/07--)  
ÜL (09/89-09/96)

**034 009 0003**  
81.11101.6012

**Fuel filter**



**Notes**

	Plastic
Diameter [mm]	36
Height [mm]	52
Port Thread	M20x1,5
	Pre-filter

**References**

81.11101.6012	81.12102.0002
81.11101.6016	

**Application info**

CLA (01/06--)  
E 2000 (05/00--)  
F 2000 (01/94-12/95)  
M 2000 L (08/95--)  
M 2000 M (--12/05)  
M 90 (08/88-06/96)  
NG (--07/98)  
NL (--07/98)  
NM (--03/97)

NÜ (09/96-07/98)  
R (05/85-01/93)  
SD (04/74-04/94)  
SG (07/76-06/97)  
SL (05/80-04/87)  
SL II (--04/94)  
SM (11/87-02/95)  
SR (10/75-11/86)  
SÜ (--06/97)

**034 323 0003**  
 81.11101.6151

**Fuel filter**
**References**

81.11101.6013                      81.11101.6151

**Application info**

 EM (08/87-06/97)  
 F 2000 (01/94-12/95)  
 F 90 (07/86-12/97)  
 F 90 Unterflur (07/86-05/94)  
 L 2000 (10/93-07/97)  
 LION'S COACH (09/95--)  
 LION'S STAR (01/93-09/96)

 M 2000 L (08/95--)  
 M 2000 M (--12/05)  
 NM (--03/97)  
 SM (11/87-02/95)  
 SÜ (--06/97)  
 TGA (04/00--)  
 ÜL (09/89-09/96)

**Fuel filter**
**12-34 323 0006**  
 81.12503.0054

**Notes**

 Diameter [mm]                      13.8  
 Outer Diameter [mm]              83  
 Height [mm]                         145  
     Filter Insert

**References**

 81.00000.0246                      81.12503.0048  
 81.12503.0021                      81.12503.0054  
 81.12503.0022                      81.12503.0063  
 81.12503.0042

**Application info**

 EL (01/93-06/97)  
 F 90 (07/86-12/97)  
 F 90 Unterflur (07/86-05/94)  
 SD (04/74-04/94)  
 SG (07/76-06/97)

 SL (05/80-04/87)  
 SL II (--04/94)  
 SÜ (--06/97)  
 ÜL (09/89-09/96)



1

**12-34 323 0005**  
81.12503.0085

**Fuel filter**



**Notes**

Height [mm] 54  
Filter Insert

**References**

81.12501.0031 82.12503.0069  
81.12503.0085

**Application info**

F 2000 (01/94-12/95) TGA (04/00--)

**12-34 323 0003**  
81.12503.0086

**Fuel filter**



**Notes**

Height [mm] 55  
Filter Insert

**References**

81.12501.0021 81.12503.0033  
81.12501.0026 81.12503.0086  
81.12501.0030

**Application info**

TGA (04/00--)  
TGS (09/07--) TGX (09/07--)

**12-34 323 0004**  
85.12501.0002

**Fuel filter**



**Notes**

Height [mm] 54  
Filter Insert

**References**

81.12501.0022 81.12503.0080  
81.12501.0032 85.12501.0002  
81.12501.0034





**12-34 323 0004**  
 85.12501.0002

**Fuel filter**
**Application info**

CLA (01/06--)	NL (--07/98)
EM (08/87-06/97)	NM (--03/97)
L 2000 (10/93-07/97)	NÜ (09/96-07/98)
LION'S COACH (09/95--)	SM (11/87-02/95)
M 2000 L (08/95--)	TGL (04/05--)
M 2000 M (--12/05)	TGM (10/05--)
NG (--07/98)	

**12-34 030 0009**  
 64.96020.0003

**Engine mount**
**Notes**

	Rubber Bush
Inner Diameter [mm]	15
Outer Diameter [mm]	96
Outer Diameter [mm]	90
Height [mm]	85
	Left and right
	Rear

**References**

64.96020.0003	81.96020.0382
81.96020.0205	88.96210.0004
81.96020.0235	

**Application info**

CLA (01/06--)	M 2000 M (--12/05)
EM (08/87-06/97)	M 90 (08/88-06/96)
F 90 (07/86-12/97)	NL (--07/98)
L 2000 (10/93-07/97)	NM (--03/97)
M 2000 L (08/95--)	SM (11/87-02/95)

**12-34 030 0004**  
 81.41506.0096

**Engine mount**
**Notes**

	Rubber-metal Bearing
Height [mm]	91
Thread Size	M10x1,5
	Left and right
	Front and Rear

**References**

81.41506.0096

**Application info**

L 2000 (10/93-07/97)	M 90 (08/88-06/96)
M 2000 L (08/95--)	TGL (04/05--)



1

**12-34 030 0011**  
81.96020.0202

**Engine mount**



**Notes**

	Rubber Bush
Inner Diameter [mm]	30
Inner Diameter [mm]	18
Outer Diameter [mm]	80
Outer Diameter [mm]	75
Height [mm]	56
	Left and right
	Front

**References**

81.96020.0202	81.96020.0239
---------------	---------------

**Application info**

G 90 (09/87-05/95)  
M 2000 L (08/95--)

M 2000 M (--12/05)  
M 90 (08/88-06/96)

**12-34 030 0012**  
81.96020.0340

**Engine mount**



**Notes**

	Rubber Bush
Inner Diameter [mm]	88
Inner Diameter [mm]	70
Outer Diameter [mm]	36
Outer Diameter [mm]	20
Height [mm]	72
	Left and right
	Front

**References**

81.96020.0340	81.96020.0372
---------------	---------------

**Application info**

F 2000 (01/94-12/95)

F 90 (07/86-12/97)

**12-34 030 0007**  
81.96020.0341

**Engine mount**



**Notes**

	Rubber Bush
Inner Diameter [mm]	22
Outer Diameter [mm]	106
Outer Diameter [mm]	70
Height [mm]	85
	Left and right
	Front

**References**

81.96020.0341	81.96020.0408
81.96020.0373	

+

**Engine mount**
**12-34 030 0007**  
 81.96020.0341

**Application info**

 F 2000 (01/94-12/95)  
 F 90 (07/86-12/97)

 TGA (04/00--)  
 TGX (09/07--)

**Engine mount**
**12-34 030 0006**  
 81.96020.0402

**Notes**

	Rubber Bush
Inner Diameter [mm]	22
Outer Diameter [mm]	124
Outer Diameter [mm]	104
Height [mm]	117
	Left and right
	Rear

**References**

81.96020.0402

**Application info**

F 2000 (01/94-12/95)

**Engine mount**
**12-34 030 0013**  
 81.96020.0403

**Notes**

	Rubber Bush
Inner Diameter [mm]	35
Inner Diameter [mm]	15
Outer Diameter [mm]	96
Outer Diameter [mm]	90
Height [mm]	85
	Front

**References**

81.96020.0391

81.96020.0403

**Application info**

F 2000 (01/94-12/95)



1

**12-34 030 0008**  
81.96210.0388

**Engine mount**



**Notes**

Outer Diameter [mm]  
Height [mm]  
Thread Size

Rubber-metal Bearing  
100  
67  
M16x1,5  
Rear

**References**

81.96210.0388  
81.96210.0494

81.96210.0495

**Application info**

F 2000 (01/94-12/95)

F 90 (07/86-12/97)

**12-34 030 0003**  
81.96210.0571

**Engine mount**



**Notes**

Height [mm]  
Width [mm]  
Thread Size  
Thread Size  
Length [mm]

Rubber-metal Bearing  
173  
127  
M14x2  
M18x1,5  
178  
Left and right  
Front

**References**

81.96210.0562  
81.96210.0571

81.96210.0575  
81.96210.0577

**Application info**

LION'S COACH (09/95--)  
TGA (04/00--)

TGS (09/07--)  
TGX (09/07--)

**12-34 030 0000**  
81.96210.0574

**Engine mount**



**Notes**

Thread Size

Rubber-metal Bearing  
M16x1,5  
Left and right  
Front

**References**

81.96210.0525  
81.96210.0553

81.96210.0574

**Engine mount**
**12-34 030 0000**  
 81.96210.0574

**Application info**

 TGA (04/00--)  
**Engine mount**
**12-34 030 0002**  
 81.96210.0597

**Notes**

	Rubber-metal Bearing
	Steel Elastomer
Bore Ø [mm]	15
Height [mm]	160
Required quantity	2
	Left and right
	Rear

**References**

81.96210.0572	81.96210.0597
81.96210.0592	

**Application info**

LION'S COACH (09/95--)	TGS (09/07--)
TGA (04/00--)	TGX (09/07--)

**Engine mount**
**12-34 030 0001**  
 81.96210.6072

**Notes**

	Rubber-metal Bearing
	Steel Elastomer
	Left and right
	Rear

**References**

81.96210.6065	81.96210.6072
81.96210.6071	

**Application info**

LION'S COACH (09/95--)	TGA (04/00--)
LION'S STAR (01/93-09/96)	



1

**12-14 234 0027**  
51.06600.7006

**Radiator fan motor**

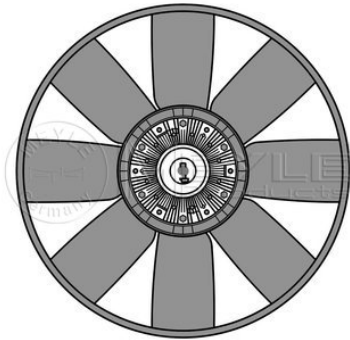

**References**  
51.06600.7006

**Application info**

TGA (04/00--)  
TGL (04/05--)

TGM (10/05--)

**12-14 234 0014**  
51.06600.7017

**Radiator fan motor**

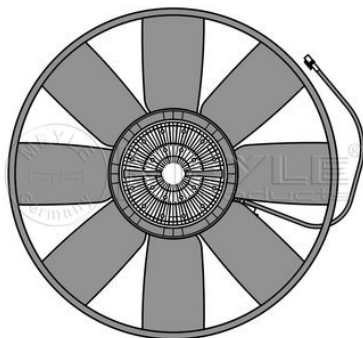

**Notes**

Electric

**References**

51.06600.7017  
51.06600.7026  
51.06600.7031

51.06600.7033  
51.06600.7036  
51.06601.7019

**Application info**

E 2000 (05/00--)  
F 2000 (01/94-12/95)  
TGA (04/00--)

TGS (09/07--)  
TGX (09/07--)

**12-14 234 0029**  
51.06600.7025

**Radiator fan motor**

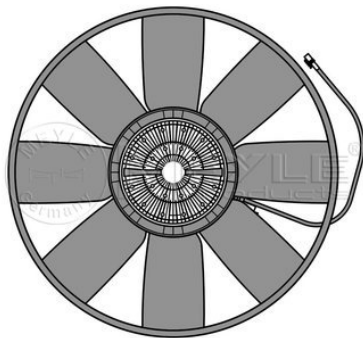

**References**

51.06600.7025



**Radiator fan motor**
**12-14 234 0029**  
 51.06600.7025

**Application info**

 TGA (04/00--)  
 TGS (09/07--)

TGX (09/07--)

**Radiator fan motor**
**12-14 234 0013**  
 51.06600.7030

**References**

51.06600.7030

51.06600.9030

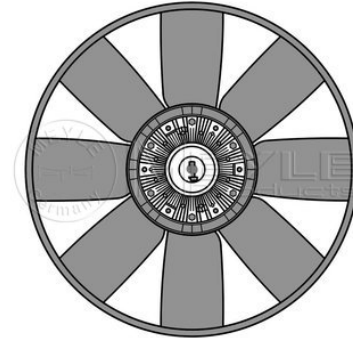
**Application info**

E 2000 (05/00--)

F 2000 (01/94-12/95)

**Radiator fan motor**
**12-14 234 0025**  
 51.06600.7045

**Notes**

Number of Wings

9

Electric

Outer Diameter [mm]

754

**References**

51.06600.7008

51.06600.7045

51.06600.7015

51.06600.9045

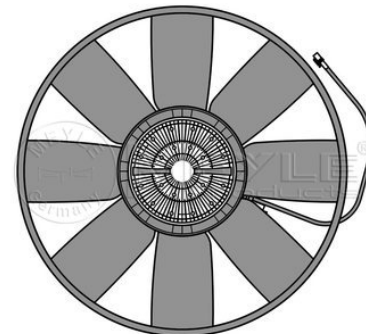
**Application info**

LION'S COACH (09/95--)

NG (--07/98)

NL (--07/98)

NÜ (09/96-07/98)

TGA (04/00--)

TGS (09/07--)

TGX (09/07--)



1

**12-14 234 0016**  
51.06601.7009

**Radiator fan motor**

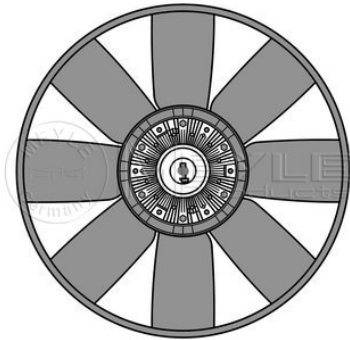

**References**  
51.06601.7009

**Application info**

E 2000 (05/00--)

F 2000 (01/94-12/95)

**12-14 234 0017**  
51.06601.7010

**Radiator fan motor**

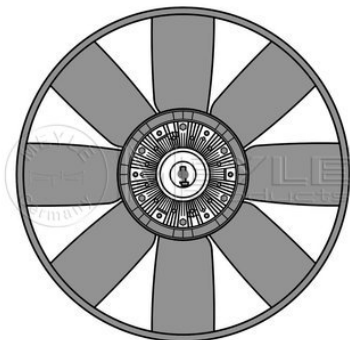

**References**  
51.06601.7010

**Application info**

E 2000 (05/00--)

F 2000 (01/94-12/95)

**12-14 234 0018**  
51.06601.7015

**Radiator fan motor**

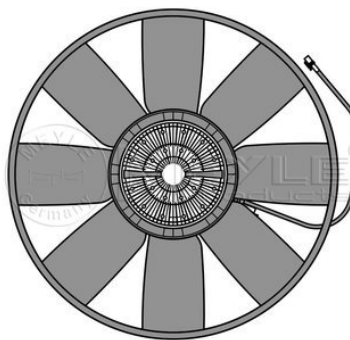

**References**  
51.06601.7015

**Application info**

F 2000 (01/94-12/95)

TGA (04/00--)



**12-14 223 0002**  
 81.06111.0020

**Radiator cap**
**Notes**

Pressure [bar] 0.7

**References**

81.06111.0019 81.06111.0020

**Application info**

CLA (01/06--)	M 2000 M (--12/05)
EL (01/93-06/97)	M 90 (08/88-06/96)
EM (08/87-06/97)	NG (--07/98)
F 2000 (01/94-12/95)	NL (--07/98)
F 90 (07/86-12/97)	NM (--03/97)
F 90 Unterflur (07/86-05/94)	NÜ (09/96-07/98)
L 2000 (10/93-07/97)	TGA (04/00--)
LION'S COACH (09/95--)	TGL (04/05--)
LION'S STAR (01/93-09/96)	TGM (10/05--)
M 2000 L (08/95--)	ÜL (09/89-09/96)

**12-14 234 0023**  
 51.06630.0007

**Fan clutch**
**Notes**

Thermic

**References**

51.06630.0007

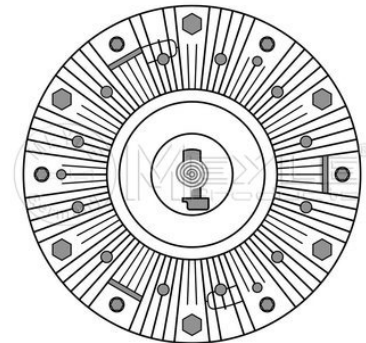
**Application info**

M 90 (08/88-06/96)



1

**12-14 234 0021**

51.06630.0031

**Fan clutch**

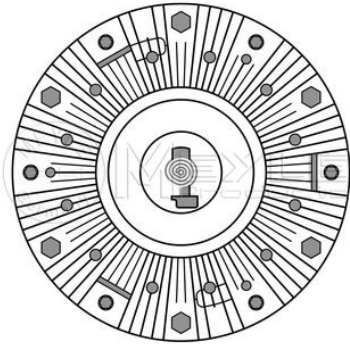

**Notes**

Number of mounting bores	4
	Thermic
Outer Diameter [mm]	180
Depth [mm]	115

**References**

51.06630.0031	51.06630.0043
51.06630.0042	

**Application info**

G 90 (09/87-05/95)

**12-14 234 0020**

51.06630.0037

**Fan clutch**

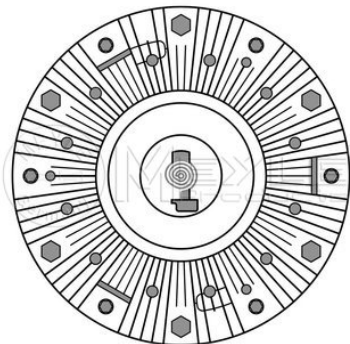

**Notes**

Number of mounting bores	4
	Thermic
Depth [mm]	120

**References**

51.06630.0037	51.06630.0058
51.06630.0049	51.06630.9037

**Application info**

EM (08/87-06/97)  
G (10/79-08/88)  
G 90 (09/87-05/95)  
HOCL (01/85-05/09)  
L 2000 (10/93-07/97)

M 2000 L (08/95--)  
M 2000 M (--12/05)  
M 90 (08/88-06/96)  
NM (--03/97)  
SM (11/87-02/95)

**12-14 234 0022**

51.06630.0038

**Fan clutch**

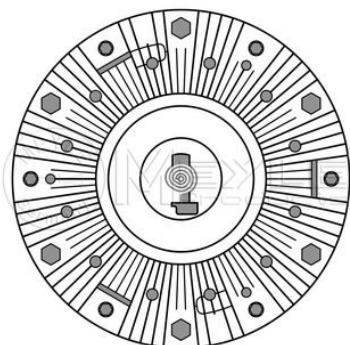

**Notes**

Number of mounting bores	4
	Thermic
Outer Diameter [mm]	178
Depth [mm]	110

**References**

51.06630.0038



**Fan clutch**
**12-14 234 0022**  
 51.06630.0038

**Application info**

G 90 (09/87-05/95)

**Fan clutch**
**12-14 234 0019**  
 51.06630.0047

**Notes**

 Number of mounting bores      4  
    Thermic

**References**

51.06630.0047

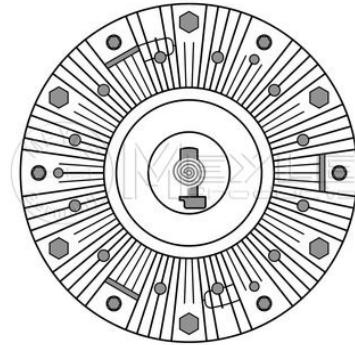
**Application info**

F 90 (07/86-12/97)

**Fan clutch**
**12-14 234 0024**  
 51.06630.0053

**Notes**

Thermic

**References**

51.06630.0053

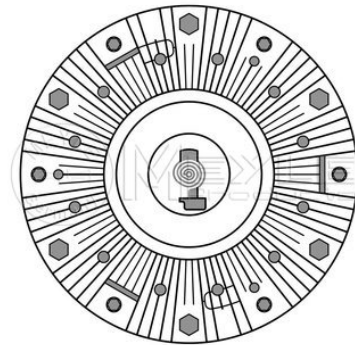
**Application info**

M 90 (08/88-06/96)



1

**12-14 234 0001**  
51.06630.0060

**Fan clutch**



**Notes**

Number of mounting bores	4
	Thermic
Outer Diameter [mm]	204
Depth [mm]	54
Hole Arrangement / Number	4

**References**

51.06601.7002	51.06630.0060
51.06601.7003	51.06630.0065
51.06601.7006	51.06630.0070
51.06601.7008	

**Application info**

E 2000 (05/00--)

F 2000 (01/94-12/95)

**12-14 234 0015**  
51.06630.0064

**Fan clutch**

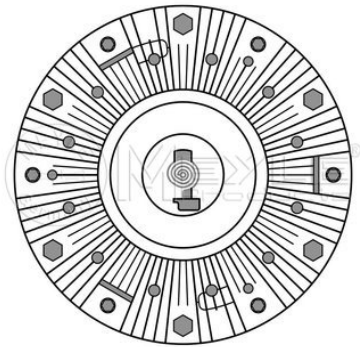

**Notes**

Thermic

**References**

51.06601.7013	51.06630.0069
51.06630.0064	51.06630.0072

**Application info**

E 2000 (05/00--)

F 2000 (01/94-12/95)

**12-14 234 0002**  
51.06630.0066

**Fan clutch**



**Notes**

Number of mounting bores	4
	Thermic
Outer Diameter [mm]	203
Depth [mm]	120
Hole Arrangement / Number	4

**References**

51.06630.0062	51.06630.0066
---------------	---------------

**Application info**

F 2000 (01/94-12/95)

**12-14 234 0010**  
 51.06630.0067

**Fan clutch**
**Notes**

Number of mounting bores	4
	Thermic
Diameter [mm]	186
Outer Diameter [mm]	186
Depth [mm]	108
Hole Arrangement / Number	4

**References**

51.06630.0050	51.06630.0067
---------------	---------------

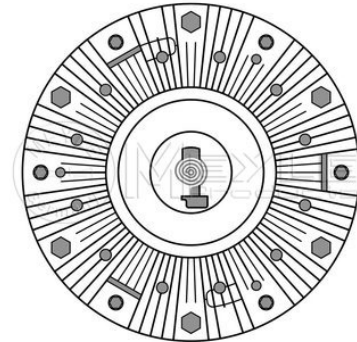
**Application info**

EM (08/87-06/97)  
 G 90 (09/87-05/95)  
 L 2000 (10/93-07/97)

M 90 (08/88-06/96)  
 TGL (04/05--)  
 TGM (10/05--)

**12-14 234 0008**  
 51.06630.0068

**Fan clutch**
**Notes**

Number of mounting bores	6
	Thermic
Outer Diameter [mm]	290
Depth [mm]	153
Hole Arrangement / Number	4

**References**

51.06630.0055	51.06630.0068
51.06630.0061	51.06630.9068

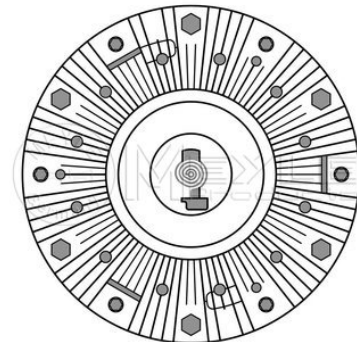
**Application info**

E 2000 (05/00--)  
 F 2000 (01/94-12/95)

F 90 (07/86-12/97)  
 F 90 Unterflur (07/86-05/94)

**12-14 234 0011**  
 51.06630.0071

**Fan clutch**
**Notes**

Number of mounting bores	6
	Thermic
Outer Diameter [mm]	165
Depth [mm]	51
Hole Arrangement / Number	6

**References**

51.06630.0071
---------------

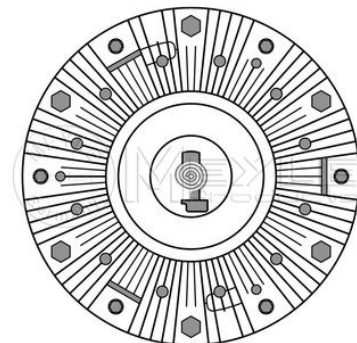



1

**12-14 234 0011**  
51.06630.0071

**Fan clutch**

**Application info**

L 2000 (10/93-07/97)  
M 2000 L (08/95--)

TGL (04/05--)

**12-14 234 0009**  
51.06630.0077

**Fan clutch**

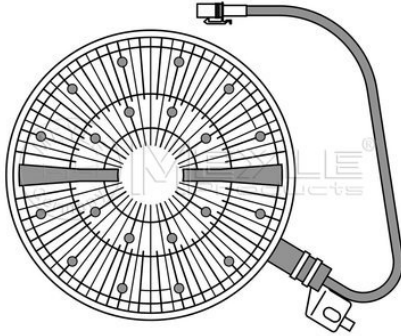

**Notes**

Number of mounting bores	6
Outer Diameter [mm]	236
Hole Arrangement / Number	4
Depth [mm]	138
Number of Poles	2

**References**

51.06630.0073	51.06630.0077
---------------	---------------

**Application info**

F 2000 (01/94-12/95)  
LION'S CITY (08/04--)

LION'S COACH (09/95--)  
TGA (04/00--)

**12-14 234 0026**  
51.06630.0082

**Fan clutch**

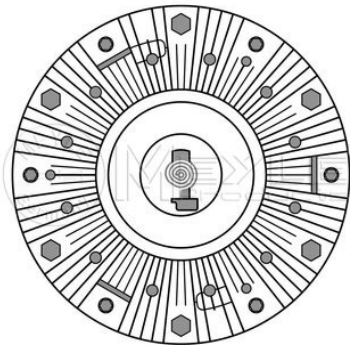

**Notes**

Number of mounting bores	4
Outer Diameter [mm]	205
Depth [mm]	99

**References**

51.06630.0082

**Application info**

TGA (04/00--)  
TGL (04/05--)

TGM (10/05--)

**Fan clutch**
**12-14 234 0012**  
 51.06630.0093

**Notes**

Number of mounting bores	6
	Electric
Outer Diameter [mm]	236
Depth [mm]	119
Number of Poles	2

**References**

51.06630.0093	51.06630.0112
---------------	---------------

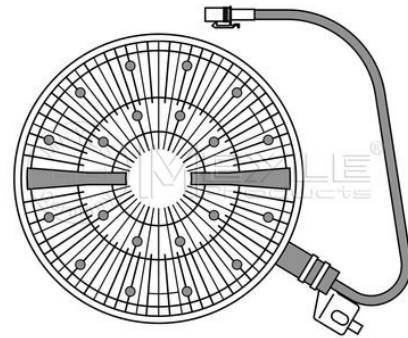
**Application info**

E 2000 (05/00--)	F 2000 (01/94-12/95)
------------------	----------------------

**Fan clutch**
**12-14 234 0030**  
 51.06630.0094

**Notes**

Number of mounting bores	6
	Electric
Outer Diameter [mm]	190
Depth [mm]	128

**References**

51.06630.0094	51.06630.0117
51.06630.0113	

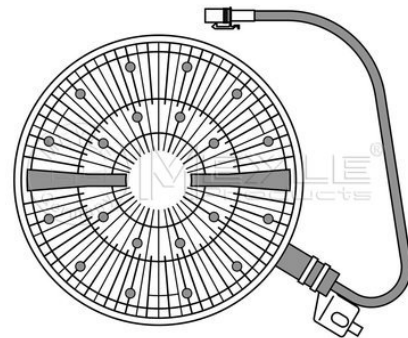
**Application info**

TGA (04/00--)	TGX (09/07--)
TGS (09/07--)	

**Fan clutch**
**12-14 234 0007**  
 51.06630.0115

**Notes**

Number of mounting bores	6
	Electric
Outer Diameter [mm]	232
Hole Arrangement / Number	4
Depth [mm]	144
Number of Poles	2

**References**

51.06630.0076	51.06630.0115
51.06630.0108	

**Application info**

E 2000 (05/00--)	TGA (04/00--)
F 2000 (01/94-12/95)	



1

**12-14 234 0031**  
51.06630.0124

**Fan clutch**

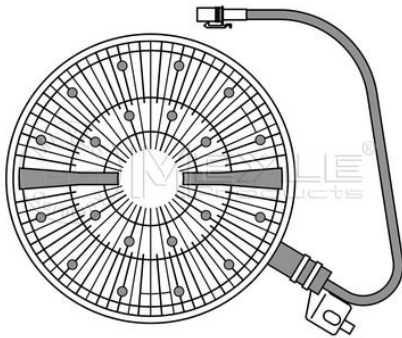

**Notes**

Number of mounting bores	6
Outer Diameter [mm]	240
Depth [mm]	132

**References**

51.06630.0124	51.06630.0127
---------------	---------------

**Application info**

TGA (04/00--)  
TGS (09/07--)

TGX (09/07--)

**12-14 234 0004**  
51.06630.0129

**Fan clutch**



**Notes**

Number of mounting bores	6
Outer Diameter [mm]	245
Hole Arrangement / Number	4
Depth [mm]	132
Number of Poles	2

**References**

51.06630.0096	51.06630.0129
---------------	---------------

**Application info**

TGA (04/00--)

**12-14 234 0006**  
51.06630.0130

**Fan clutch**



**Notes**

Number of mounting bores	6
Outer Diameter [mm]	245
Hole Arrangement / Number	4
Depth [mm]	161
Number of Poles	2

**References**

51.06630.0106	51.06630.0130
---------------	---------------

+



**12-14 234 0006**  
 51.06630.0130

**Fan clutch**
**Application info**

 LION'S COACH (09/95--)  
 NG (--07/98)  
 NL (--07/98)  
 NÜ (09/96-07/98)

 TGA (04/00--)  
 TGS (09/07--)  
 TGX (09/07--)

**12-14 234 0005**  
 51.06630.0131

**Fan clutch**
**Notes**

Number of mounting bores	4
	Electric
Outer Diameter [mm]	205
Hole Arrangement / Number	4
Depth [mm]	140
Number of Poles	2

**References**

51.06630.0107	51.06630.0131
---------------	---------------

**Application info**

 TGA (04/00--)  
 TGS (09/07--)

TGX (09/07--)

**12-14 234 0028**  
 51.06630.0136

**Fan clutch**
**Notes**

Number of mounting bores	4
	Electric
Outer Diameter [mm]	246
Depth [mm]	165

**References**

51.06630.0119	51.06630.0140
51.06630.0136	

**Application info**

 TGA (04/00--)  
 TGS (09/07--)

TGX (09/07--)



1

**12-34 232 0011**  
51.06601.0102

**Fan blade**

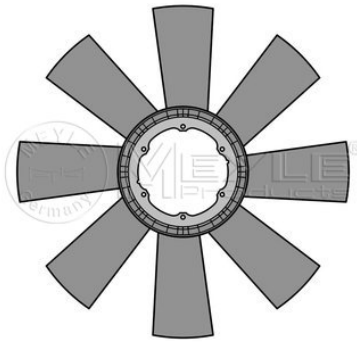

**Notes**

Number of Wings	9
Outer Diameter [mm]	620

**References**

51.06601.0102

**Application info**

HOCL (01/85-05/09)

**12-34 232 0004**  
51.06601.0172

**Fan blade**

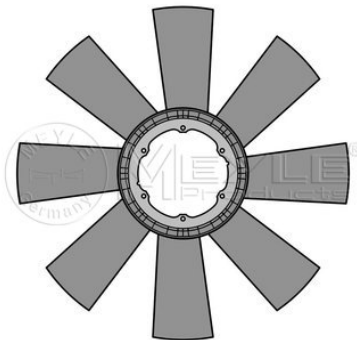

**Notes**

Number of Wings	8
Diameter [mm]	725

**References**

51.06601.0172

**Application info**

F 90 (07/86-12/97)  
F 90 Unterflur (07/86-05/94)  
SG (07/76-06/97)

SR (10/75-11/86)  
SÜ (--06/97)

**12-34 232 0009**  
51.06601.0177

**Fan blade**

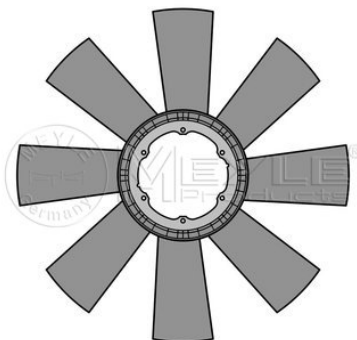

**Notes**

Number of Wings	10
Outer Diameter [mm]	480

**References**

51.06601.0177	51.06601.0230
---------------	---------------

**Application info**

G 90 (09/87-05/95)

**12-34 232 0012**  
 51.06601.0178

**Fan blade**
**Notes**

 Number of Wings 10  
 Outer Diameter [mm] 560

**References**

51.06601.0178

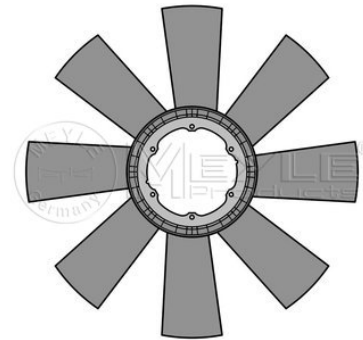
**Application info**

L 2000 (10/93-07/97)

**12-34 232 0010**  
 51.06601.0199

**Fan blade**
**Notes**

 Number of Wings 9  
 Outer Diameter [mm] 590

**References**

51.06601.0198                      51.06601.0199

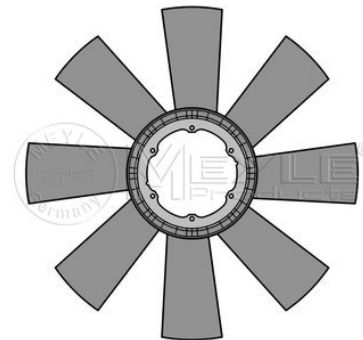
**Application info**

HOCL (01/85-05/09)

**12-34 232 0017**  
 51.06601.0233

**Fan blade**
**Notes**

 Number of Wings 10  
 Outer Diameter [mm] 750

**References**

51.06601.0233

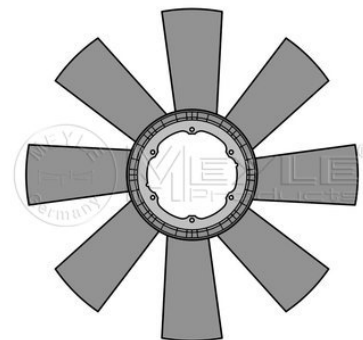
**Application info**

 SD (04/74-04/94)  
 SG (07/76-06/97)  
 SL (05/80-04/87)

 SM (11/87-02/95)  
 SR (10/75-11/86)  
 SÜ (-06/97)



1

**12-34 232 0008**  
51.06601.0234

**Fan blade**

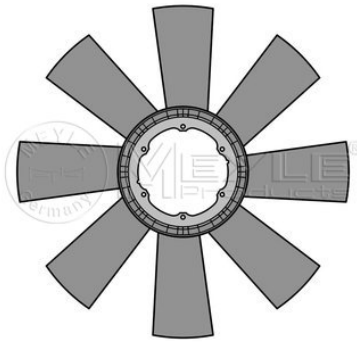

**Notes**

Number of Wings 10

**References**

51.06601.0234

**Application info**

F 90 (07/86-12/97)

**12-34 232 0003**  
51.06601.0250

**Fan blade**

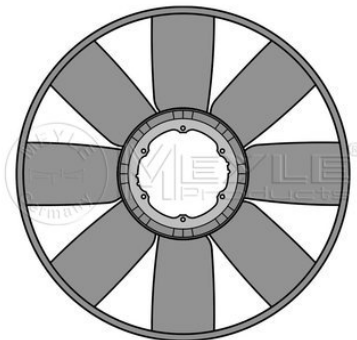

**Notes**

Number of Wings 8  
Diameter [mm] 704

**References**

51.06601.0250

**Application info**

F 2000 (01/94-12/95)

**12-34 232 0001**  
51.06601.0256

**Fan blade**



**Notes**

Number of Wings 9  
Diameter [mm] 704

**References**

51.06601.0256



**12-34 232 0001**  
 51.06601.0256

**Fan blade**
**Application info**

 F 2000 (01/94-12/95)  
 F 90 (07/86-12/97)  
 F 90 Unterflur (07/86-05/94)  
 LION'S COACH (09/95--)

 NG (--07/98)  
 NL (--07/98)  
 NÜ (09/96-07/98)

**12-34 232 0002**  
 51.06601.0257

**Fan blade**
**Notes**

 Number of Wings                    9  
 Diameter [mm]                      754

**References**

51.06601.0257

**Application info**

 LION'S COACH (09/95--)  
 LION'S STAR (01/93-09/96)

TGA (04/00--)

**12-34 232 0015**  
 51.06601.0258

**Fan blade**
**References**

51.06601.0258

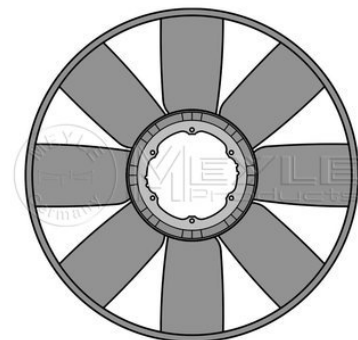
**Application info**

M 2000 L (08/95--)



1

**12-34 232 0005**

51.06601.0263

**Fan blade**

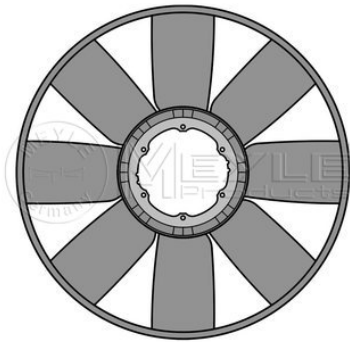

**Notes**

Number of Wings	9
Outer Diameter [mm]	704

**References**

51.06601.0263

**Parts list**

12-14 234 0007	Fan clutch
----------------	------------

**Application info**

E 2000 (05/00--)  
F 2000 (01/94-12/95)  
TGA (04/00--)

TGS (09/07--)  
TGX (09/07--)

**12-34 232 0013**

51.06601.0265

**Fan blade**

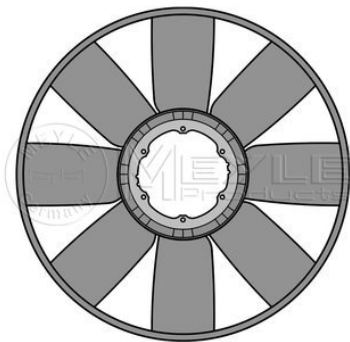

**Notes**

Number of Wings	8
Outer Diameter [mm]	600

**References**

51.06601.0265

**Application info**

L 2000 (10/93-07/97)  
M 2000 L (08/95--)

M 2000 M (--12/05)

**12-34 232 0014**

51.06601.0266

**Fan blade**

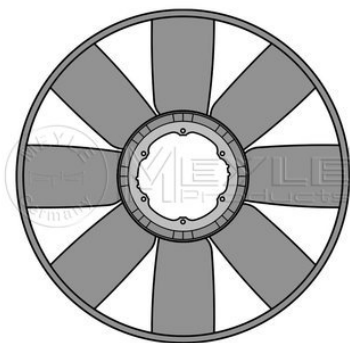

**Notes**

Number of Wings	8
Outer Diameter [mm]	600

**References**

51.06601.0266



**Fan blade**
**12-34 232 0014**  
 51.06601.0266

**Application info**

 L 2000 (10/93-07/97)  
 M 2000 L (08/95--)

 M 2000 M (--12/05)  
 TGL (04/05--)

**Fan blade**
**12-34 232 0006**  
 51.06601.0268

**Notes**

 Number of Wings                    9  
 Outer Diameter [mm]            750

**References**

51.06601.0268

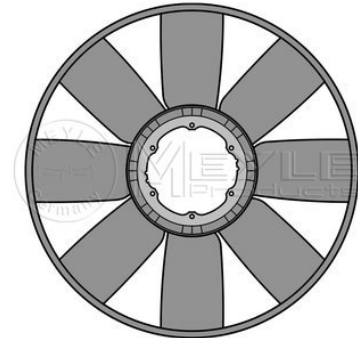
**Application info**

 E 2000 (05/00--)  
 F 2000 (01/94-12/95)  
 TGA (04/00--)

 TGS (09/07--)  
 TGX (09/07--)

**Fan blade**
**12-34 020 0001**  
 51.06601.0275

**Notes**

 Number of Wings                    9  
 Diameter [mm]                    750

**References**

51.06601.0275

**Application info**

 TGA (04/00--)  
 TGS (09/07--)

TGX (09/07--)



1

**12-34 232 0018**  
51.06601.0279

**Fan blade**

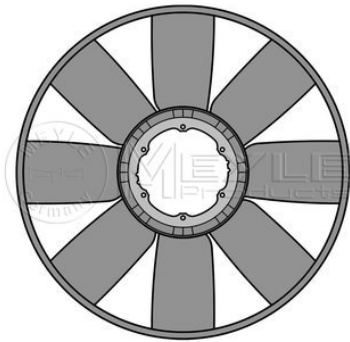

**Notes**

Number of Wings	9
Outer Diameter [mm]	704

**References**

51.06601.0273	51.06601.0279
---------------	---------------

**Application info**

TGA (04/00--)  
TGS (09/07--)

TGX (09/07--)

**12-34 232 0020**  
51.06601.0282

**Fan blade**

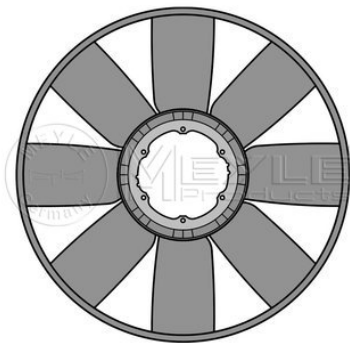

**References**

51.06601.0282

**Application info**

TGA (04/00--)  
TGS (09/07--)

TGX (09/07--)

**12-34 232 0019**  
51.06601.0283

**Fan blade**

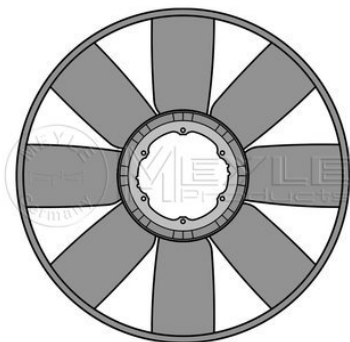

**Notes**

Number of Wings	11
Outer Diameter [mm]	750

**References**

51.06601.0283





**Fan blade**
**12-34 232 0019**  
 51.06601.0283

**Application info**

 TGA (04/00--)  
 TGS (09/07--)

TGX (09/07--)

**Fan blade**
**12-34 232 0016**  
 81.06601.0042

**References**

81.06601.0042

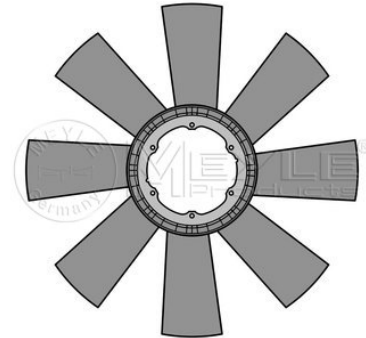
**Application info**

NG (--07/98)

NL (--07/98)

**Fan blade**
**12-34 232 0007**  
 81.06601.0069

**Notes**

Number of Wings

9

**References**

81.06601.0069

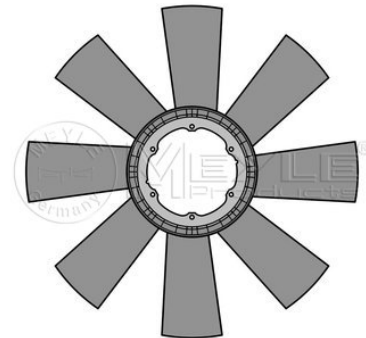
**Application info**

 EL (01/93-06/97)  
 NL (--07/98)

SG (07/76-06/97)



1

**14-34 232 0012**  
81.06601.0072

**Fan blade**

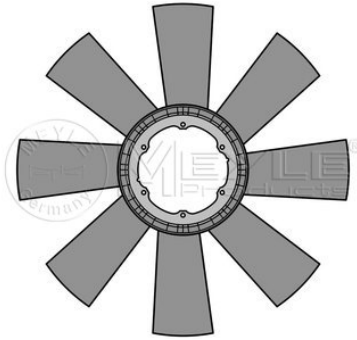

**Notes**

Number of Wings	7
Outer Diameter [mm]	720

**References**

81.06601.0072

**Application info**

HOCL (01/85-05/09)  
SL II (-04/94)

SÜ (-06/97)

**033 020 0022**  
51.06500.6282

**Water pump**



**Notes**

Impeller Diameter [mm]	for v-ribbed belt use 125
Weight [kg]	10.36
	with seal
	1-part housing
	Metal impeller
	without belt pulley

**References**

51.06500.6282	51.06500.6387
51.06500.6384	51.06500.9282

**Parts list**

028 280 0002	Thermostat
028 283 0000	Thermostat
12-28 265 0001	Thermostat
12-28 279 0000	Thermostat

**Application info**

SD (04/74-04/94)  
SL (05/80-04/87)

SÜ (-06/97)

**12-33 500 6408**  
 51.06500.6408

**Water pump**
**Notes**

with seal  
 1-part housing  
 without belt pulley  
 16

Diameter [mm]

**References**

51.06500.6408

51.06500.9408

**Parts list**

028 271 0001	Thermostat
028 280 0002	Thermostat
028 283 0000	Thermostat
12-28 265 0001	Thermostat
12-28 279 0000	Thermostat

**Application info**

F 2000 (01/94-12/95)  
 F 90 (07/86-12/97)  
 F 90 Unterflur (07/86-05/94)

M 90 (08/88-06/96)  
 SÜ (--06/97)  
 ÜL (09/89-09/96)

**Water pump**
**033 020 0043**  
 51.06500.6426

**Notes**

Impeller Diameter [mm]  
 Weight [kg]

for v-ribbed belt use  
 135  
 11.2  
 with seal  
 1-part housing  
 Metal impeller  
 without belt pulley

**References**

51.06500.6426

**Parts list**

028 271 0001	Thermostat
028 280 0002	Thermostat
028 283 0000	Thermostat
12-28 265 0001	Thermostat
12-28 279 0000	Thermostat

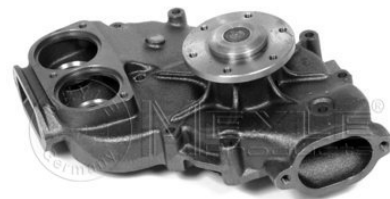
**Application info**

E 2000 (05/00--)  
 F 2000 (01/94-12/95)

TGA (04/00--)



1

**033 020 0048**  
51.06500.6479

**Water pump**



**Notes**

Impeller Diameter [mm]  
Weight [kg]

for v-ribbed belt use  
135  
11.35  
with seal  
1-part housing  
Metal impeller  
without belt pulley

**References**

51.06500.6479

51.06500.9479

**Parts list**

028 271 0001  
028 280 0002  
028 283 0000  
12-28 265 0001  
12-28 279 0000

Thermostat  
Thermostat  
Thermostat  
Thermostat  
Thermostat

**Application info**

F 90 (07/86-12/97)  
F 90 Unterflur (07/86-05/94)  
LION'S COACH (09/95--)  
LION'S STAR (01/93-09/96)

NG (--07/98)  
NL (--07/98)  
SÜ (--06/97)

**12-34 500 6495**  
51.06500.6495

**Water pump**



**Notes**

Belt Pulley Ø [mm]

with seal  
135

**References**

51.06500.6495

51.06500.9495

**Application info**

EM (08/87-06/97)  
F 2000 (01/94-12/95)  
L 2000 (10/93-07/97)  
M 2000 L (08/95--)

M 90 (08/88-06/96)  
NM (--03/97)  
SM (11/87-02/95)

**12-34 500 6543**  
 51.06500.6543

**Water pump**
**Notes**

 Height [mm] with gaskets/seals  
 79.5

**References**

51.06500.6543 51.06500.9543

**Application info**

 EL (01/93-06/97)  
 NG (-07/98)  
 NL (-07/98)

 NM (-03/97)  
 NÜ (09/96-07/98)

**Water pump**
**12-33 500 0001**  
 51.06500.6546

**Notes**

 with seal  
 1-part housing  
 Pulley

**References**

51.06500.6546 51.06500.9546

**Parts list**

 028 283 0000 Thermostat  
 12-28 279 0000 Thermostat

**Application info**

 F 2000 (01/94-12/95)  
 F 90 (07/86-12/97)

F 90 Unterflur (07/86-05/94)

**Water pump**
**12-33 500 6547**  
 51.06500.6547

**Notes**

 with seal  
 1-part housing  
 with belt pulley

**References**

 51.06500.6545 51.06500.9545  
 51.06500.6547 51.06500.9547

**Parts list**

 028 283 0000 Thermostat  
 12-28 265 0001 Thermostat  
 12-28 279 0000 Thermostat



1

**12-33 500 6547**  
51.06500.6547

**Water pump**

**Application info**

F 2000 (01/94-12/95)  
F 90 (07/86-12/97)

F 90 Unterflur (07/86-05/94)

**12-33 500 6548**  
51.06500.6548

**Water pump**



**Notes**

Number of Wings 12  
with seal

**References**

51.06500.6548 51.06500.9548

**Parts list**

028 283 0000 Thermostat  
12-28 265 0001 Thermostat  
12-28 279 0000 Thermostat

**Application info**

E 2000 (05/00--)  
F 90 (07/86-12/97)  
LION'S COACH (09/95--)  
NG (--07/98)  
NL (--07/98)

NÜ (09/96-07/98)  
TGA (04/00--)  
TGS (09/07--)  
TGX (09/07--)

**12-33 220 0003**  
51.06500.6616

**Water pump**



**Notes**

Height [mm] with seal  
127

**References**

51.06500.6616 51.06500.9616

**Parts list**

028 283 0000 Thermostat  
12-28 265 0001 Thermostat  
12-28 279 0000 Thermostat

**Application info**

TGA (04/00--)

TGX (09/07--)

**Water pump**
**12-34 500 6646**  
 51.06500.6646

**Notes**

 Number of Wings 8  
 with seal

**References**

 51.06500.6646 51.06500.9050  
 51.06500.6676 51.06500.9646  
 51.06500.7050

**Application info**

 NG (-07/98) NÜ (09/96-07/98)  
 NL (-07/98)

**Water pump**
**12-34 500 6612**  
 51.06500.6669

**Notes**

 with seal  
 without belt pulley

**References**

 51.06500.6606 51.06500.9606  
 51.06500.6612 51.06500.9612  
 51.06500.6669 51.06500.9669

**Application info**

 EM (08/87-06/97) M 90 (08/88-06/96)  
 L 2000 (10/93-07/97) NM (-03/97)  
 M 2000 L (08/95--) SM (11/87-02/95)  
 M 2000 M (-12/05)

**Water pump**
**12-34 500 6642**  
 51.06500.6675

**Notes**

 Number of Wings 8  
 with seal

**References**

 51.06500.6642 51.06500.9642  
 51.06500.6675



1

**12-34 500 6642**  
51.06500.6675

**Water pump**

**Application info**

L 2000 (10/93-07/97)  
M 2000 L (08/95--)  
M 90 (08/88-06/96)

TGA (04/00--)  
TGS (09/07--)  
TGX (09/07--)

**12-34 220 0004**  
51.06500.6680

**Water pump**



**Notes**

with seal

**References**

51.06500.6587  
51.06500.6651  
51.06500.6680

51.06500.7070  
51.06500.7079  
51.06500.9079

**Application info**

TGL (04/05--)

TGM (10/05--)

**12-14 234 0003**  
51.06500.7049

**Water pump**

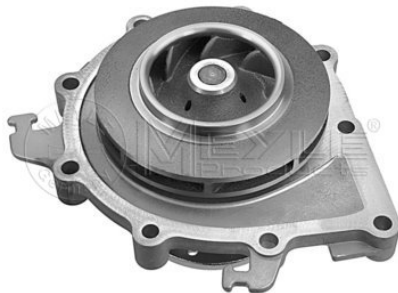

**Notes**

Impeller Diameter [mm]  
Weight [kg]

for v-ribbed belt use  
135  
4.1  
with seal  
1-part housing  
Metal impeller  
without belt pulley

**References**

51.06500.6637  
51.06500.7049

51.06500.9049

**Application info**

TGA (04/00--)  
TGS (09/07--)

TGX (09/07--)



**12-34 500 7064**  
 51.06500.7064

**Water pump**
**Notes**

Number of Wings                      8  
     with seal

**References**

51.06500.6679	51.06500.9078
51.06500.7064	51.06500.9679
51.06500.7078	51.06500.9699
51.06500.9064	

**Application info**

FOCL (---)	M 2000 L (08/95--)
HOCL (01/85-05/09)	TGA (04/00--)
L 2000 (10/93-07/97)	

**Water pump**
**12-33 220 0001**  
 51.06500.7066

**Notes**

Weight [kg]                              10.4  
     with seal  
     1-part housing  
     without belt pulley

**References**

51.06500.7033	51.06500.7052
51.06500.7036	51.06500.7065
51.06500.7043	51.06500.7066
51.06500.7045	51.06500.9048
51.06500.7047	51.06500.9052
51.06500.7048	51.06500.9066
51.06500.7051	51.06500.9548

**Application info**

F 2000 (01/94-12/95)	TGA (04/00--)
----------------------	---------------

**Thermostat**
**028 283 0000**  
 51.06402.0063

**Notes**

Opening Temperature [°C]            with seal  
     83

**References**

51.06402.0058	51.06402.0063
51.06402.0060	51.06402.0066





**028 283 0000**  
51.06402.0063

**Thermostat**

**Application info**

- |                              |                  |
|------------------------------|------------------|
| CLA (01/06--)                | NL (--07/98)     |
| EL (01/93-06/97)             | NÜ (09/96-07/98) |
| F 2000 (01/94-12/95)         | SD (04/74-04/94) |
| F 90 (07/86-12/97)           | SG (07/76-06/97) |
| F 90 Unterflur (07/86-05/94) | SL (05/80-04/87) |
| LION'S COACH (09/95--)       | SR (10/75-11/86) |
| LION'S COMFORT (09/96--)     | SÜ (--06/97)     |
| LION'S STAR (01/93-09/96)    | TGA (04/00--)    |
| M 90 (08/88-06/96)           | ÜL (09/89-09/96) |
| NG (--07/98)                 |                  |

**12-28 279 0000**  
51.06402.0064

**Thermostat**



**Notes**

Opening Temperature [°C] with seal  
79

**References**

- |               |               |
|---------------|---------------|
| 51.06402.0034 | 51.06402.0061 |
| 51.06402.0050 | 51.06402.0064 |
| 51.06402.0056 | 51.06402.0067 |

**Application info**

- |                              |                    |
|------------------------------|--------------------|
| CLA (01/06--)                | M 2000 M (--12/05) |
| EL (01/93-06/97)             | M 90 (08/88-06/96) |
| EM (08/87-06/97)             | NG (--07/98)       |
| F 2000 (01/94-12/95)         | NL (--07/98)       |
| F 90 (07/86-12/97)           | NM (--03/97)       |
| F 90 Unterflur (07/86-05/94) | NÜ (09/96-07/98)   |
| G (10/79-08/88)              | R (05/85-01/93)    |
| G 90 (09/87-05/95)           | SG (07/76-06/97)   |
| L 2000 (10/93-07/97)         | SM (11/87-02/95)   |
| LION'S COACH (09/95--)       | SR (10/75-11/86)   |
| LION'S COMFORT (09/96--)     | SÜ (--06/97)       |
| LION'S STAR (01/93-09/96)    | TGA (04/00--)      |
| M 2000 L (08/95--)           | ÜL (09/89-09/96)   |

**12-14 223 0001**  
 81.06102.6209

**Expansion tank**
**Notes**

Opening Pressure [bar]	Transparent without add-on material 0.7 PP (Polypropylene)
Width [mm]	321
Depth [mm]	108
Length [mm]	743
Capacity [Litre]	8 with valves with filler cap Front

**References**

81.06102.6110	81.06102.6209
81.06102.6112	81.06102.6222
81.06102.6205	81.06102.6227

**Parts list**

12-14 223 0002	Radiator cap
039 238 0001	Expansion tank cap

**Application info**

E 2000 (05/00–)

F 2000 (01/94-12/95)

**12-14 223 0004**  
 81.06102.6218

**Expansion tank**
**Notes**

Opening Pressure [bar]	Transparent without add-on material 0.7 PP (Polypropylene)
Width [mm]	321
Depth [mm]	130
Length [mm]	742
Capacity [Litre]	8.4 with valves with filler cap Front

**References**

81.06102.6098	81.06102.6202
81.06102.6099	81.06102.6218
81.06102.6201	

**Parts list**

12-14 223 0002	Radiator cap
039 238 0001	Expansion tank cap





1

**12-14 223 0004**  
81.06102.6218

**Expansion tank**

**Application info**

E 2000 (05/00--)  
EL (01/93-06/97)  
F 2000 (01/94-12/95)  
F 90 (07/86-12/97)  
F 90 Unterflur (07/86-05/94)  
HOCL (01/85-05/09)  
LION'S COACH (09/95--)  
LION'S STAR (01/93-09/96)

NG (--07/98)  
NL (--07/98)  
NM (--03/97)  
NÜ (09/96-07/98)  
SÜ (--06/97)  
TGA (04/00--)  
ÜL (09/89-09/96)

**12-14 223 0005**  
81.06102.6219

**Expansion tank**



**Notes**

Opening Pressure [bar]	Black without add-on material 0.7
Width [mm]	PP (Polypropylene) 321
Depth [mm]	130
Length [mm]	742
Capacity [Litre]	5.6
	with valves
	with filler cap
	Front

**References**

81.06102.6109	81.06102.6219
81.06102.6204	

**Parts list**

12-14 223 0002	Radiator cap
039 238 0001	Expansion tank cap

**Application info**

F 90 (07/86-12/97)

F 90 Unterflur (07/86-05/94)

**12-14 223 0006**  
 81.06102.6220

**Expansion tank**
**Notes**

Opening Pressure [bar]	Transparent without add-on material 0.7 PP (Polypropylene)
Width [mm]	321
Depth [mm]	130
Length [mm]	742
Capacity [Litre]	5.6 with valves with filler cap Front

**References**

81.06102.6089	81.06102.6203
81.06102.6100	81.06102.6220

**Parts list**

12-14 223 0002	Radiator cap
039 238 0001	Expansion tank cap

**Application info**

M 2000 M (-12/05)

**12-14 223 0003**  
 81.06102.6226

**Expansion tank**
**Notes**

Opening Pressure [bar]	Black without add-on material 0.7 PP (Polypropylene)
Width [mm]	321
Depth [mm]	142
Length [mm]	743
Capacity [Litre]	14 with valves with filler cap Front

**References**

81.06102.6117	81.06102.6221
81.06102.6206	81.06102.6226
81.06102.6208	

**Parts list**

12-14 223 0002	Radiator cap
039 238 0001	Expansion tank cap

**Application info**

 E 2000 (05/00--)  
 F 2000 (01/94-12/95)

TGA (04/00--)



1

**12-34 223 0001**  
81.27421.0152

**Sensor, coolant level**



**Notes**

Operating voltage [V] 24  
Number of Poles 2

**References**

81.27421.0152 81.27421.0169

**Application info**

F 2000 (01/94-12/95)  
L 2000 (10/93-07/97)

LION'S COACH (09/95--)  
M 2000 L (08/95--)

**039 238 0001**  
81.06111.0018

**Expansion tank cap**



**Notes**

Pressure [bar] 0.45  
Diameter [mm] 76

**References**

81.06111.0018

**Application info**

E 2000 (05/00--)  
F 2000 (01/94-12/95)  
F 90 (07/86-12/97)  
F 90 Unterflur (07/86-05/94)  
M 90 (08/88-06/96)

TGA (04/00--)  
TGL (04/05--)  
TGM (10/05--)  
TGS (09/07--)  
TGX (09/07--)

**12-39 222 0026**  
04.27405.9160

**Radiator hose**



**Notes**

Inner Diameter [mm] 60  
Outer Diameter [mm] 68  
Length [mm] 1000

**References**

04.27405.0601 04.27405.9360  
04.27405.9160 N1.01100.8494



**12-39 222 0026**  
 04.27405.9160

**Radiator hose**
**Application info**

F 2000 (01/94-12/95)	TGL (04/05--)
L 2000 (10/93-07/97)	TGM (10/05--)
M 2000 L (08/95--)	TGS (09/07--)
M 2000 M (--12/05)	TGX (09/07--)
TGA (04/00--)	

**12-39 222 0019**  
 04.27405.9502

**Radiator hose**
**Notes**

	Rubber with textile reinforcement
Inner Diameter [mm]	10
Outer Diameter [mm]	18
Length [mm]	2000

**References**

04.27405.9502	04.27405.9510
---------------	---------------

**Application info**

CLA (01/06--)	TGM (10/05--)
F 2000 (01/94-12/95)	TGS (09/07--)
TGA (04/00--)	TGX (09/07--)
TGL (04/05--)	

**12-39 222 0014**  
 81.96301.0581

**Radiator hose**
**Notes**

	from engine to engine cooler
	Rubber with textile reinforcement
Inner Diameter [mm]	48
Outer Diameter [mm]	58

**References**



81.96301.0581	81.96301.0676
---------------	---------------

**Application info**

L 2000 (10/93-07/97)



1

<p><b>12-39 222 0015</b> 81.96301.0621</p>		<p><b>Radiator hose</b></p>	
		<p><b>Notes</b></p> <p>from engine to engine cooler with angled water pipe Rubber with textile reinforcement</p> <p>Inner Diameter [mm] 55 Outer Diameter [mm] 67</p> <p><b>References</b></p> <p>81.96301.0582</p>	<p>81.96301.0621</p>
<p><b>Application info</b> L 2000 (10/93-07/97)</p>			
<p><b>12-39 222 0001</b> 81.96301.0659</p>		<p><b>Radiator hose</b></p>	
		<p><b>Notes</b></p> <p>from expansion tank to water pipe Rubber with textile reinforcement</p> <p>Inner Diameter [mm] 58 Outer Diameter [mm] 68</p> <p><b>References</b></p> <p>81.96301.0496 81.96301.0659</p>	<p>82.96301.0008</p>
<p><b>Application info</b> F 2000 (01/94-12/95) F 90 (07/86-12/97)</p>		<p>TGA (04/00--) TGX (09/07--)</p>	
<p><b>12-39 222 0005</b> 81.96301.0677</p>		<p><b>Radiator hose</b></p>	
		<p><b>Notes</b></p> <p>from engine to engine cooler Rubber with textile reinforcement</p> <p>Inner Diameter [mm] 58 Outer Diameter [mm] 68</p> <p><b>References</b></p> <p>81.96301.0677</p>	
<p><b>Application info</b> TGA (04/00--) TGS (09/07--)</p>		<p>TGX (09/07--)</p>	



**12-39 222 0018**  
 81.96301.0679

**Radiator hose**
**Notes**

from engine to engine cooler  
 Rubber with textile reinforcement  
 Inner Diameter [mm] 60  
 Outer Diameter [mm] 70

**References**

81.96301.0679

**Application info**

TGA (04/00--)

**12-39 222 0017**  
 81.96301.0680

**Radiator hose**
**Notes**

from radiator to water pipe  
 Rubber with textile reinforcement  
 Inner Diameter [mm] 60  
 Outer Diameter [mm] 70

**References**

81.96301.0680

**Application info**

TGA (04/00--)

**12-39 222 0008**  
 81.96301.0892

**Radiator hose**
**Notes**

from radiator to intermediate piece  
 Rubber with textile reinforcement  
 Inner Diameter [mm] 58  
 Outer Diameter [mm] 68  
 Lower

**References**

81.96301.0892





**Application info**

 TGA (04/00--)  
 TGS (09/07--)

TGX (09/07--)



1

<p><b>12-39 222 0007</b> 81.96301.0893</p>		<p><b>Radiator hose</b></p>	
		<p><b>Notes</b></p> <p>from radiator to water pipe Rubber with textile reinforcement</p> <p>Inner Diameter [mm] 58 Outer Diameter [mm] 68 Lower</p> <p><b>References</b> 81.96301.0893</p>	
<p><b>Application info</b> F 2000 (01/94-12/95) TGA (04/00--)</p>		<p>TGS (09/07--) TGX (09/07--)</p>	
<p><b>12-39 222 0006</b> 81.96301.0898</p>		<p><b>Radiator hose</b></p>	
		<p><b>Notes</b></p> <p>from engine to engine cooler Rubber with textile reinforcement</p> <p>Inner Diameter [mm] 58 Outer Diameter [mm] 68 Lower</p> <p><b>References</b> 81.96301.0898      82.96301.0006</p>	
<p><b>Application info</b> TGA (04/00--)</p>		<p>TGX (09/07--)</p>	
<p><b>12-39 222 0003</b> 81.96305.0088</p>		<p><b>Radiator hose</b></p>	
		<p><b>Notes</b></p> <p>with angled water pipe from expansion tank to engine cooler Rubber with textile reinforcement</p> <p>Inner Diameter [mm] 50 Outer Diameter [mm] 60 Lower</p> <p><b>References</b> 81.96305.0088</p>	
<p><b>Application info</b> F 90 (07/86-12/97)</p>			

**12-39 222 0004**  
 81.96305.0129

**Radiator hose**
**Notes**

from expansion tank to water pipe  
 with angled water pipe  
 Rubber with textile reinforcement

Inner Diameter [mm]  
 Outer Diameter [mm]

58  
 68

**References**

81.96305.0129

**Application info**

F 2000 (01/94-12/95)

**Radiator hose**
**12-39 222 0013**  
 81.96305.0134

**Notes**

from engine to water pipe  
 FPM (fluoride rubber)/ACM (polyacrylate rubber)

Inner Diameter [mm]  
 Outer Diameter [mm]

60  
 70

**References**

51.96305.0018  
 51.96305.0021  
 81.96305.0095

81.96305.0134  
 81.96305.0223  
 81.96305.0226

**Application info**

F 2000 (01/94-12/95)  
 F 90 (07/86-12/97)  
 F 90 Unterflur (07/86-05/94)  
 LION'S COACH (09/95--)  
 LION'S STAR (01/93-09/96)  
 NG (--07/98)

NL (--07/98)  
 NÜ (09/96-07/98)  
 TGA (04/00--)  
 TGX (09/07--)  
 ÜL (09/89-09/96)

**Radiator hose**
**12-39 222 0016**  
 81.96305.0166

**Notes**

from expansion tank to engine  
 cooler  
 Rubber with textile reinforcement

Inner Diameter [mm]  
 Outer Diameter [mm]

21  
 31



**References**

81.96305.0166





1

<p><b>12-39 222 0016</b> 81.96305.0166</p> <p><b>Radiator hose</b></p>	
<p><b>Application info</b> TGA (04/00--)</p>	
<p><b>12-39 222 0020</b> 81.96305.0169</p> <p><b>Radiator hose</b></p>	
	<p><b>Notes</b></p> <p>from expansion tank to distributor Rubber with textile reinforcement</p> <p>Inner Diameter [mm] 10 Outer Diameter [mm] 18</p> <p><b>References</b></p> <p>81.96305.0130                      81.96305.0169</p>
<p><b>Application info</b> F 2000 (01/94-12/95)                      TGA (04/00--)</p>	
<p><b>12-39 222 0009</b> 81.96305.0227</p> <p><b>Radiator hose</b></p>	
	<p><b>Notes</b></p> <p>from engine to water pipe Rubber with textile reinforcement</p> <p>Inner Diameter [mm] 57 Outer Diameter [mm] 68</p> <p><b>References</b></p> <p>81.96305.0227</p>
<p><b>Application info</b> TGA (04/00--)</p> <p>TGX (09/07--)</p>	

**12-39 222 0011**  
 81.96305.0230

**Radiator hose**
**Notes**

from connecting pipe to engine cooler  
 Rubber with textile reinforcement  
 Inner Diameter [mm] 58  
 Outer Diameter [mm] 68  
 Lower

**References**

81.96305.0230

**Application info**

TGA (04/00--)  
 TGS (09/07--)

TGX (09/07--)

**Belt tensioner**
**12-34 000 1002**  
 51.95800.7437

**Notes**

Outer Diameter [mm] 74  
 Height [mm] 90

**References**

51.95800.7437                      51.95800.7479

**Application info**

TGA (04/00--)  
 TGL (04/05--)

TGM (10/05--)

**Belt tensioner**
**12-34 000 1003**  
 51.95800.7459

**Notes**

Outer Diameter [mm] 74  
 Height [mm] 84

**References**

 51.95800.7428                      51.95800.7459  
 51.95800.7429                      51.95800.7477  
 51.95800.7436



1

**12-34 000 1003**  
51.95800.7459

**Belt tensioner**

**Application info**

TGA (04/00--)  
TGS (09/07--)

TGX (09/07--)

**12-34 000 1101**  
51.95800.6075

**Tension roller, ribbed belt**

**Notes**

Outer Diameter [mm]	74
Width [mm]	42

**References**

51.95800.6061	51.95800.6075
---------------	---------------

**Application info**

LION'S COACH (09/95--)  
LION'S STAR (01/93-09/96)  
NG (--07/98)

NL (--07/98)  
NÜ (09/96-07/98)  
ÜL (09/89-09/96)

**12-34 000 1004**  
51.95800.6087

**Tension roller, ribbed belt**



**Notes**

Inner Diameter [mm]	20
Outer Diameter [mm]	74
Height [mm]	28.3

**References**

51.95800.6087

**Application info**

LION'S COACH (09/95--)

LION'S STAR (01/93-09/96)

**12-34 000 1100**  
 51.95800.6092

**Tension roller, ribbed belt**
**Notes**

Inner Diameter [mm]	20
Outer Diameter [mm]	74
Height [mm]	34

**References**

51.95800.6076	51.95800.6099
51.95800.6092	

**Application info**

TGA (04/00--)	TGS (09/07--)
TGL (04/05--)	TGX (09/07--)
TGM (10/05--)	

**V-belt**
**052 013 1525**  
 06.58042.0242

**Notes**

Width [mm]	13
Length [mm]	1525

**References**

06.58042.0242	06.58073.2421
06.58043.0242	6.58041.0242
06.58043.2242	6.58043.0242
06.58047.2242	6.58043.2242
06.58072.2422	6.58072.2421

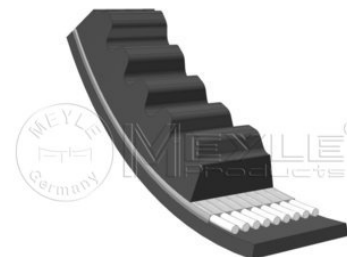
**Application info**

M 90 (08/88-06/96)

**V-belt**
**052 013 1050**  
 06.58043.0223

**Notes**

Width [mm]	13
Length [mm]	1050

**References**

06.58043.0223	6.58072.2231
06.58072.2231	

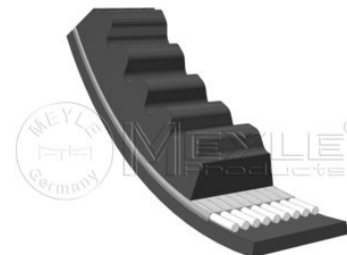
**Application info**

M 90 (08/88-06/96)



1

**052 013 1450**  
06.58043.0239

**V-belt**

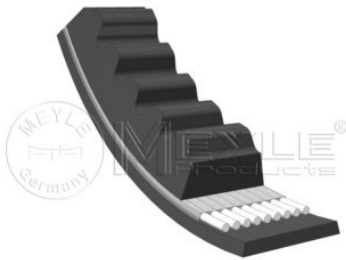

**Notes**

Width [mm] 13  
Length [mm] 1450

**References**

06.58043.0239	06.58072.2391
06.58043.2239	06.58072.2392
06.58046.0239	06.58073.2391
06.58046.2239	

**Application info**

F 2000 (01/94-12/95)  
F 90 (07/86-12/97)

F 90 Unterflur (07/86-05/94)  
M 90 (08/88-06/96)

**052 010 1250**  
06.58043.2131

**V-belt**



**Notes**

Width [mm] 10  
Length [mm] 1250

**References**

06.58043.2131

**Application info**

L 2000 (10/93-07/97)

**052 013 1600**  
06.58043.2245

**V-belt**

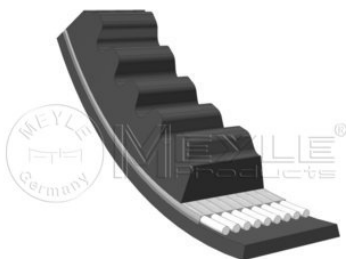

**Notes**

Width [mm] 13  
Length [mm] 1600

**References**

06.58043.2245	51.96820.6001
06.58072.2452	51.96820.6027
51.96820.3001	

**Application info**

R (05/85-01/93)  
SG (07/76-06/97)

SÜ (--06/97)



**V-belt**
**052 013 1000**  
 06.58072.2211

**Notes**

 Width [mm] 13  
 Length [mm] 1000

**References**

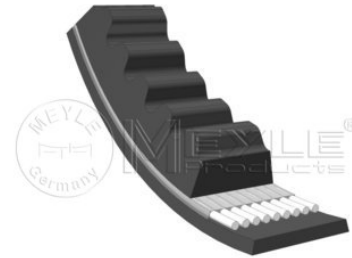
 06.58043.0221 65.80430.221  
 06.58072.2211

**Application info**

M 90 (08/88-06/96)

**V-belt**
**052 010 0975**  
 06.58073.1201

**Notes**

 Width [mm] 10  
 Length [mm] 975

**References**

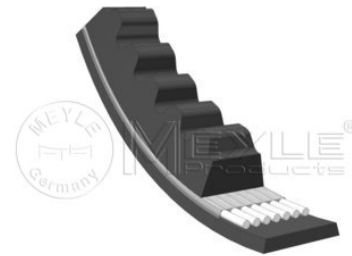
 06.58043.0120 6.58043.0120  
 06.58072.1201 6.58043.2120  
 06.58073.1201 6.58072.1201

**Application info**

M 90 (08/88-06/96)

**V-belt**
**052 010 1075**  
 06.58073.1241

**Notes**

 Width [mm] 10  
 Length [mm] 1075

**References**

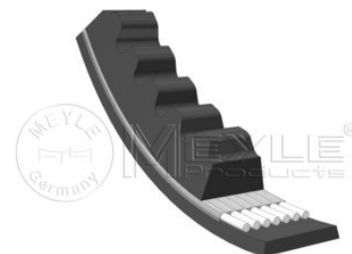
 06.58073.1241 6.58043.2124  
 6.58043.0124 6.58072.1241

**Application info**

M 90 (08/88-06/96)



1

**052 010 1100**  
06.58073.1251

**V-belt**

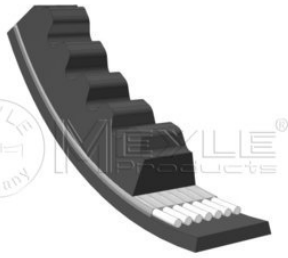

**Notes**

Width [mm]	10
Length [mm]	1100

**References**

06.58047.0125	6580 432 125
06.58073.1251	6580 470 125
6580 430 125	6580 721 251

**Application info**

M 90 (08/88-06/96)

**052 010 1380**  
06.58073.1361

**V-belt**

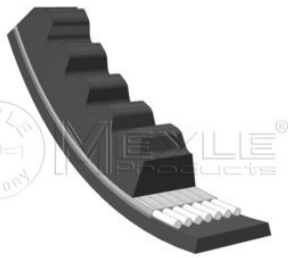

**Notes**

Width [mm]	10
Length [mm]	1380

**References**

06.58073.1361	6.58043.2136
06.58073.1362	6.58072.1361
6.58043.0136	

**Application info**

M 2000 L (08/95--)

M 2000 M (--12/05)

**052 010 1375**  
06.58073.1362

**V-belt**

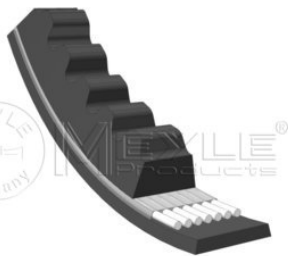

**Notes**

Width [mm]	10
Length [mm]	1375

**References**

06.58073.1361	06.58073.1362
---------------	---------------

**Application info**

M 2000 L (08/95--)

M 2000 M (--12/05)

**052 010 1425**  
 06.58073.1381

**V-belt**
**Notes**

 Width [mm] 10  
 Length [mm] 1425

**References**

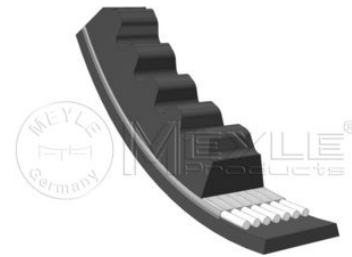
 06.58072.1361 06.58073.1381  
 06.58072.1381 51.96820.0132

**Application info**

G (10/79-08/88)

**052 010 1500**  
 06.58073.1412

**V-belt**
**Notes**

 Width [mm] 10  
 Length [mm] 1500

**References**

06.58073.1412

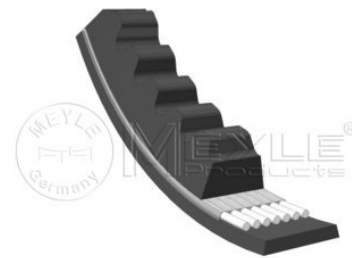
**Application info**

F 2000 (01/94-12/95)

**052 013 1155**  
 06.58073.2272

**V-belt**
**Notes**

 Width [mm] 13  
 Length [mm] 1155

**References**

06.58073.2272

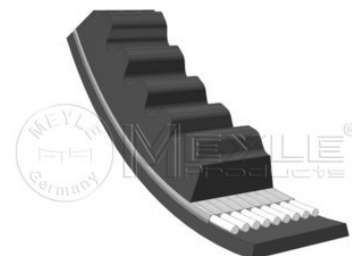



1

**052 013 1155**  
06.58073.2272

**V-belt**

**Application info**

EL (01/93-06/97)  
LION'S COACH (09/95--)  
LION'S COMFORT (09/96--)  
NG (--07/98)  
NL (--07/98)  
NÜ (09/96-07/98)

R (05/85-01/93)  
SD (04/74-04/94)  
SG (07/76-06/97)  
SL II (--04/94)  
ÜL (09/89-09/96)

**052 013 1500**  
06.58073.2411

**V-belt**

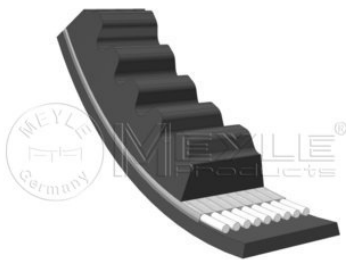

**Notes**

Width [mm]	13
Length [mm]	1500

**References**

06.58043.0241	6.58041.0241
06.58045.0241	6.58041.2241
06.58047.2241	6.58043.0241
06.58072.2412	6.58043.2241
06.58073.2411	

**Application info**

M 90 (08/88-06/96)

**052 013 1475**  
51.96820.0128

**V-belt**

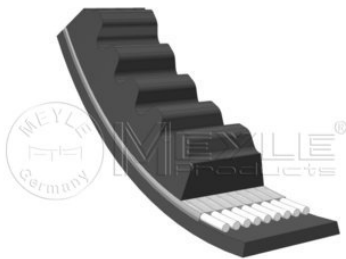

**Notes**

Width [mm]	13
Length [mm]	1475

**References**

06.58042.2240	06.58072.2402
06.58045.0240	06.58073.2401
06.58072.2401	51.96820.0128

**Application info**

F 90 (07/86-12/97)  
F 90 Unterflur (07/86-05/94)

M 90 (08/88-06/96)

**V-belt**
**052 013 1550**  
 51.96820.0143

**Notes**

 Width [mm] 13  
 Length [mm] 1550

**References**

06.58043.0243	06.58072.2433
06.58043.2243	06.58073.2431
06.58047.2243	51.96820.0143
06.58072.2431	51.96820.0153
06.58072.2432	

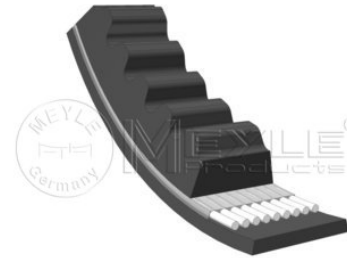
**Application info**

F 90 (07/86-12/97)

**V-ribbed belt**
**050 004 1295**  
 51.96820.0205

**Notes**

	EPDM (ethylene propylene diene Monomer (M-class) rubber)
Width [mm]	14
Number of Ribs	4
Length [mm]	1295
	One-sided

**References**

51.96820.0205

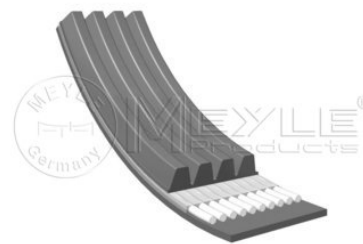
**Application info**

M 2000 L (08/95--)

**V-ribbed belt**
**050 008 0880**  
 51.96820.0238

**Notes**

	EPDM (ethylene propylene diene Monomer (M-class) rubber)
Width [mm]	28
Number of Ribs	8
Length [mm]	880
	One-sided

**References**

51.96820.0238

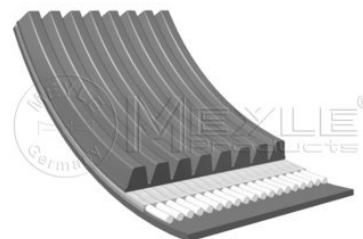
**Application info**

 F 2000 (01/94-12/95)  
 TGA (04/00--)

TGX (09/07--)



1

**050 008 1376**  
51.96820.0239

**V-ribbed belt**

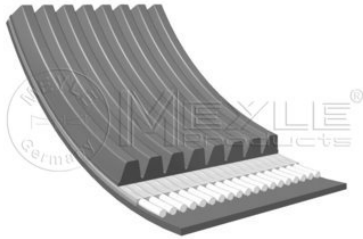

**Notes**

Width [mm]  
Number of Ribs  
Length [mm]

EPDM (ethylene propylene diene  
Monomer (M-class) rubber)  
28  
8  
1376  
One-sided

**References**

51.96820.0239

**Application info**

E 2000 (05/00--)  
F 2000 (01/94-12/95)

TGA (04/00--)

**050 008 1275**  
51.96820.0243

**V-ribbed belt**

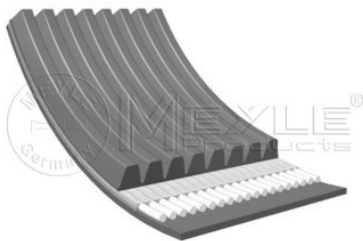

**Notes**

Width [mm]  
Number of Ribs  
Length [mm]

EPDM (ethylene propylene diene  
Monomer (M-class) rubber)  
28  
8  
1275  
One-sided

**References**

51.96820.0243  
51.96820.0257

51.96820.0280

**Application info**

TGA (04/00--)  
TGL (04/05--)

TGS (09/07--)  
TGX (09/07--)

**050 010 1980**  
51.96820.0248

**V-ribbed belt**

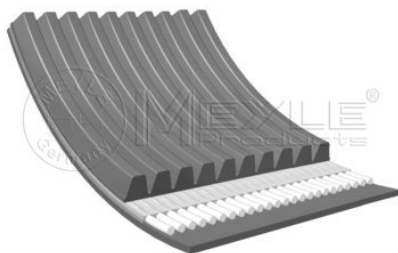

**Notes**

Width [mm]  
Number of Ribs  
Length [mm]

EPDM (ethylene propylene diene  
Monomer (M-class) rubber)  
35  
10  
1980  
One-sided

**References**

51.96820.0248



**V-ribbed belt**

**050 010 1980**  
51.96820.0248

**Application info**

LION'S CITY (08/04--)	NÜ (09/96-07/98)
NG (--07/98)	SÜ (--06/97)
NL (--07/98)	ÜL (09/89-09/96)

**V-ribbed belt**

**050 012 1515**  
51.96820.0250

**Notes**

	EPDM (ethylene propylene diene Monomer (M-class) rubber)
Width [mm]	42
Number of Ribs	12
Length [mm]	1515
	One-sided

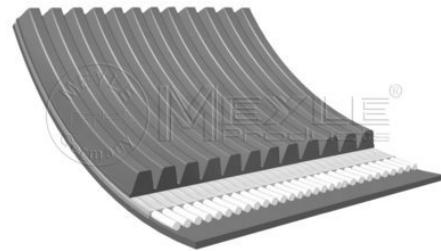

**References**

51.96820.0250

**Application info**

TGA (04/00--)	TGL (04/05--)
---------------	---------------

**V-ribbed belt**

**050 004 0790**  
51.96820.0251

**Notes**

	EPDM (ethylene propylene diene Monomer (M-class) rubber)
Width [mm]	14
Number of Ribs	4
Length [mm]	790
	One-sided

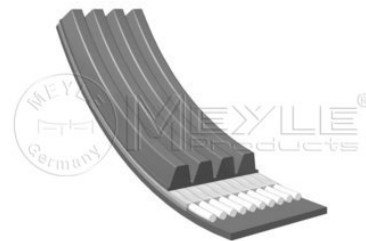

**References**

51.96820.0251

**Application info**

EL (01/93-06/97)



1

<p><b>050 005 1482</b> 51.96820.0271</p>		<p><b>V-ribbed belt</b></p>	
		<p><b>Notes</b></p> <p>EPDM (ethylene propylene diene Monomer (M-class) rubber)</p> <p>Width [mm] 18 Number of Ribs 5 Length [mm] 1482 One-sided</p> <p><b>References</b> 51.96820.0271</p>	
<p><b>Application info</b> TGA (04/00--)</p>		<p>TGX (09/07--)</p>	
<p><b>050 008 1915</b> 51.96820.0273</p>		<p><b>V-ribbed belt</b></p>	
		<p><b>Notes</b></p> <p>EPDM (ethylene propylene diene Monomer (M-class) rubber)</p> <p>Width [mm] 28 Number of Ribs 8 Length [mm] 1915 One-sided</p> <p><b>References</b> 51.96820.0273      51.96820.0335</p>	
<p><b>Application info</b> TGA (04/00--)</p>			
<p><b>050 009 1725</b> 51.96820.0308</p>		<p><b>V-ribbed belt</b></p>	
		<p><b>Notes</b></p> <p>EPDM (ethylene propylene diene Monomer (M-class) rubber)</p> <p>Width [mm] 32 Number of Ribs 9 Length [mm] 1725 One-sided</p> <p><b>References</b> 51.96820.0308</p>	
<p><b>Application info</b> TGA (04/00--)</p>			



**050 004 1390**  
 51.96820.0317

**V-ribbed belt**
**Notes**

EPDM (ethylene propylene diene Monomer (M-class) rubber)

Width [mm] 14  
 Number of Ribs 4  
 Length [mm] 1390  
 One-sided

**References**

51.96820.0304 51.96820.0317  
 51.96820.0314

**Application info**

TGA (04/00--)  
 TGL (04/05--)

TGM (10/05--)

**050 008 1158**  
 51.96820.0322

**V-ribbed belt**
**Notes**

EPDM (ethylene propylene diene Monomer (M-class) rubber)

Width [mm] 28  
 Number of Ribs 8  
 Length [mm] 1158  
 One-sided

**References**

51.96820.0322

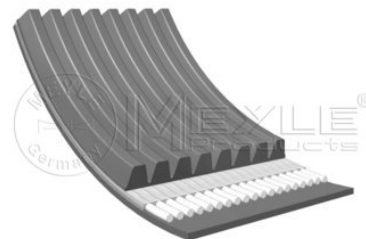
**Application info**

HOCL (01/85-05/09)  
 NG (-07/98)  
 NL (-07/98)

NÜ (09/96-07/98)  
 SÜ (-06/97)

**050 010 1688**  
 51.96820.0325

**V-ribbed belt**
**Notes**

EPDM (ethylene propylene diene Monomer (M-class) rubber)

Width [mm] 35  
 Number of Ribs 10  
 Length [mm] 1688  
 One-sided

**References**

51.96820.0325

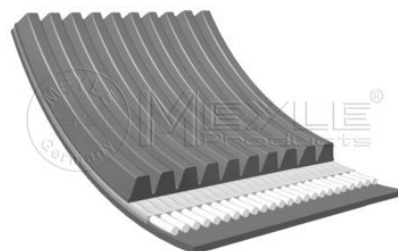



1

**050 010 1688**  
51.96820.0325

**V-ribbed belt**

**Application info**

NG (-07/98)  
NL (-07/98)

NÜ (09/96-07/98)  
SÜ (-06/97)

**050 005 1530**  
51.96820.0332

**V-ribbed belt**

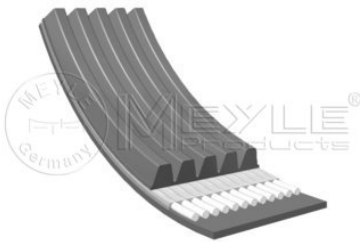

**Notes**

Width [mm]  
Number of Ribs  
Length [mm]

EPDM (ethylene propylene diene  
Monomer (M-class) rubber)  
18  
5  
1530  
One-sided

**References**

51.96820.0332

**Application info**

LION'S COACH (09/95--)

**050 008 1635**  
51.96820.0344

**V-ribbed belt**

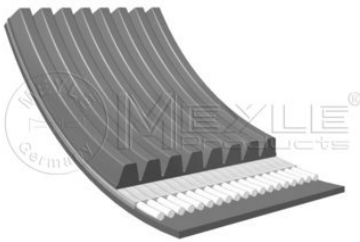

**Notes**

Width [mm]  
Number of Ribs  
Length [mm]

EPDM (ethylene propylene diene  
Monomer (M-class) rubber)  
28  
8  
1635  
One-sided

**References**

51.96820.0272

51.96820.0344

**Application info**

TGA (04/00--)

**050 008 1920**  
 51.96820.0345

**V-ribbed belt**
**Notes**

EPDM (ethylene propylene diene  
 Monomer (M-class) rubber)

Width [mm] 28  
 Number of Ribs 8  
 Length [mm] 1920  
 One-sided

**References**

51.96820.0345

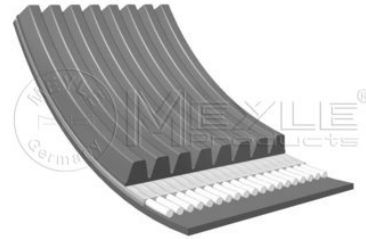
**Application info**

TGA (04/00-)

**050 008 1655**  
 51.96820.0346

**V-ribbed belt**
**Notes**

EPDM (ethylene propylene diene  
 Monomer (M-class) rubber)

Width [mm] 28  
 Number of Ribs 8  
 Length [mm] 1655  
 One-sided

**References**

51.96820.0346

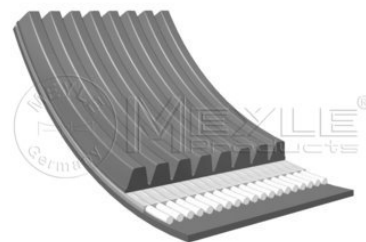
**Application info**

TGA (04/00-)

**050 012 1630**  
 81.96820.0047

**V-ribbed belt**
**Notes**

EPDM (ethylene propylene diene  
 Monomer (M-class) rubber)

Width [mm] 42  
 Number of Ribs 12  
 Length [mm] 1630  
 One-sided

**References**

81.96820.0047

**Application info**

TGA (04/00-)



1

**050 008 0855**  
81.96820.0051

**V-ribbed belt**

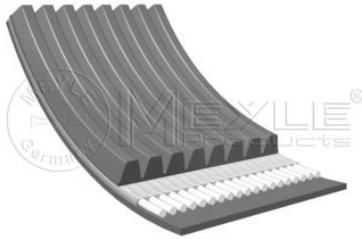

**Notes**

Width [mm]  
Number of Ribs  
Length [mm]

EPDM (ethylene propylene diene  
Monomer (M-class) rubber)  
28  
8  
855  
One-sided

**References**

81.96820.0051

**Application info**

TGL (04/05--)

**050 006 2200**  
88.96820.0001

**V-ribbed belt**

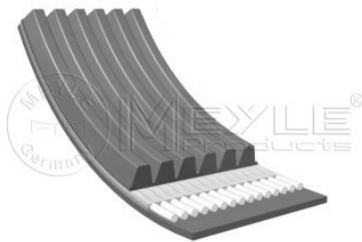

**Notes**

Width [mm]  
Number of Ribs  
Length [mm]

EPDM (ethylene propylene diene  
Monomer (M-class) rubber)  
21  
6  
2200  
One-sided

**References**

88.96820.0001

**Application info**

EL (01/93-06/97)

NL (--07/98)

**050 008 1908**  
N1.01100.1840

**V-ribbed belt**

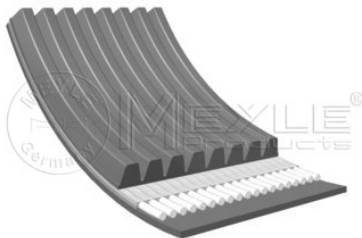

**Notes**

Width [mm]  
Number of Ribs  
Length [mm]

EPDM (ethylene propylene diene  
Monomer (M-class) rubber)  
28  
8  
1908  
One-sided

**References**

N1.01100.1840

**Application info**

TGA (04/00--)

**050 006 1180**  
 N1.01100.1846

**V-ribbed belt**
**Notes**

EPDM (ethylene propylene diene Monomer (M-class) rubber)

Width [mm] 21  
 Number of Ribs 6  
 Length [mm] 1180  
 One-sided

**References**

N1.01100.1846

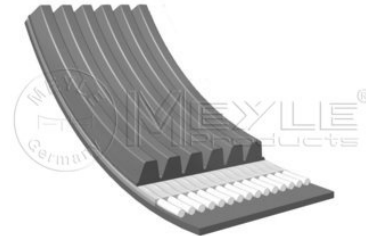

**Application info**

EL (01/93-06/97)

**050 008 1398**
**V-ribbed belt**
**Notes**

EPDM (ethylene propylene diene Monomer (M-class) rubber)

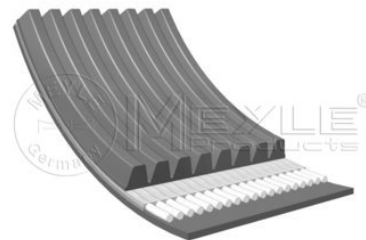
Width [mm] 28  
 Number of Ribs 8  
 Length [mm] 1398  
 One-sided

**Application info**

TGA (04/00-)

**Flex hose, exhaust system**
**12-34 152 0002**  
 81.15210.0049

**Notes**

Inner Diameter [mm] 90  
 Outer Diameter [mm] 94  
 Length [mm] 375

**References**

81.15210.0049

**Application info**

 L 2000 (10/93-07/97)  
 M 2000 L (08/95-)

M 90 (08/88-06/96)



1

**12-34 152 0003**  
81.15210.0054

**Flex hose, exhaust system**



**Notes**

Inner Diameter [mm]	110
Outer Diameter [mm]	114
Length [mm]	350

**References**

81.15210.0054

**Application info**

F 2000 (01/94-12/95)

F 90 (07/86-12/97)

**12-34 152 0007**  
81.15210.0056

**Flex hose, exhaust system**



**Notes**

Inner Diameter [mm]	80
Outer Diameter [mm]	84
Length [mm]	320

**References**

81.15210.0056

**Application info**

EM (08/87-06/97)  
L 2000 (10/93-07/97)  
M 2000 L (08/95--)

M 2000 M (--12/05)  
NM (--03/97)  
SM (11/87-02/95)

**12-34 152 0005**  
81.15210.0071

**Flex hose, exhaust system**



**Notes**

Inner Diameter [mm]	100
Outer Diameter [mm]	104
Length [mm]	325

**References**

81.15210.0071



**12-34 152 0005**  
 81.15210.0071

**Flex hose, exhaust system**
**Application info**

 F 2000 (01/94-12/95)  
 F 90 (07/86-12/97)  
 L 2000 (10/93-07/97)  
 M 2000 L (08/95-- )

 NG (--07/98)  
 NL (--07/98)  
 NÜ (09/96-07/98)

**12-34 152 0009**  
 81.15210.0078

**Flex hose, exhaust system**
**Notes**

Inner Diameter [mm]	110
Outer Diameter [mm]	115
Length [mm]	280

**References**

81.15210.0078

**Application info**

F 2000 (01/94-12/95)

F 90 (07/86-12/97)



2

**12-34 042 0014**  
81.50802.6021

**Repair kit, brake caliper**



**Notes**

Brake System  
Elsa 1  
Front Axle

**References**

81.50802.6017  
81.50802.6020  
81.50802.6021

**Application info**

F 2000 (01/94-12/95) TGA (04/00--)

**12-34 042 0015**  
81.50802.6022

**Repair kit, brake caliper**



**Notes**

Rear Axle

**References**

81.50802.6022

**Application info**

F 2000 (01/94-12/95)

**12-34 042 0017**  
81.50802.6025

**Repair kit, brake caliper**



**Notes**

Brake System  
D-Elsa 2  
Rear Axle

**References**

81.50802.6025

**Application info**

F 2000 (01/94-12/95)  
M 2000 L (08/95--)  
M 2000 M (--12/05)  
TGA (04/00--)  
TGL (04/05--)



**12-34 042 0010**  
 81.50822.6009

**Repair kit, brake caliper**

**Notes**

Front Axle

**References**

81.50822.6009



**Application info**

LION'S COACH (09/95--)

M 2000 M (--12/05)

**12-34 042 0012**  
 81.50822.6020

**Repair kit, brake caliper**

**Notes**

Diameter [mm]	69
Brake System	SK 7000
Brake System	SN 7000
Brake System	SN 6000
	Rear Axle

**References**

81.50822.6020

81.50822.6031



**Application info**

LION'S COACH (09/95--)  
 TGA (04/00--)

TGM (10/05--)

**034 042 0053**  
 81.50822.6032

**Repair kit, brake caliper**

**Notes**

Diameter [mm]	74
Brake System	SB 7000
Brake System	SB 6000
	Front Axle
	Rear Axle

**References**

81.50822.6022

81.50822.6032



**Application info**

TGA (04/00--)



2

**12-34 042 0021**  
81.50822.6034

**Repair kit, brake caliper**



**Notes**

Rear Axle

**References**

81.50822.6019  
81.50822.6034

81.50822.6037

**Application info**

TGM (10/05--)

**12-35 521 0000**  
81.50803.0010

**Brake disc**



**Notes**

Vented

Centering Diameter [mm] 135  
Minimum Thickness [mm] 24  
Outer Diameter [mm] 324  
Height [mm] 102  
Bolt Hole Circle Ø [mm] 158  
Brake Disc Thickness [mm] 30  
Number of Holes 10

Front Axle

**References**

81.50803.0010

**Application info**

L 2000 (10/93-07/97)

**12-35 521 0007**  
81.50803.0026

**Brake disc**



**Notes**

Vented

Centering Diameter [mm] 135  
Minimum Thickness [mm] 26  
Outer Diameter [mm] 330  
Height [mm] 104  
Bolt Hole Circle Ø [mm] 135  
Brake System WABCO PAN17  
Brake Disc Thickness [mm] 34  
Number of Holes 10

Front Axle

**References**

81.50803.0024

81.50803.0026



**Brake disc**
**12-35 521 0007**  
 81.50803.0026

**Application info**

L 2000 (10/93-07/97)

M 2000 L (08/95--)

**Brake disc**
**12-35 521 0008**  
 81.50803.0039

**Notes**

	Vented
Centering Diameter [mm]	145
Minimum Thickness [mm]	26
Outer Diameter [mm]	330
Height [mm]	129.5
Bolt Hole Circle Ø [mm]	177
Brake System	MERITOR D-ELSA1
Brake Disc Thickness [mm]	34
Number of Holes	8
	Rear Axle

**References**

81.50803.0039

**Application info**

L 2000 (10/93-07/97)

**Brake disc**
**12-35 521 0002**  
 81.50803.0040

**Notes**

	Vented
Centering Diameter [mm]	131
Minimum Thickness [mm]	35
Outer Diameter [mm]	432
Height [mm]	130
Bolt Hole Circle Ø [mm]	168
Brake System	MERITOR D-ELSA2
Brake Disc Thickness [mm]	45
Number of Holes	12
	Front Axle

**References**

81.50803.0023	81.50803.0036
81.50803.0031	81.50803.0038
81.50803.0033	81.50803.0040
81.50803.0034	81.50803.0046
81.50803.0035	

**Application info**

 F 2000 (01/94-12/95)  
 LION'S COACH (09/95--)  
 LION'S COMFORT (09/96--)  
 LION'S STAR (01/93-09/96)  
 M 2000 L (08/95--)

 M 2000 M (--12/05)  
 TGA (04/00--)  
 TGS (09/07--)  
 TGX (09/07--)



2

**12-35 521 0004**  
81.50803.0041

**Brake disc**



**Notes**

	Vented
Centering Diameter [mm]	208
Minimum Thickness [mm]	37
Outer Diameter [mm]	432
Height [mm]	135
Bolt Hole Circle Ø [mm]	235
Brake System	MERITOR D-ELSA1
Brake Disc Thickness [mm]	45
Number of Holes	10
	Front Axle

**References**

81.50803.0021	81.50803.0041
---------------	---------------

**Application info**

F 2000 (01/94-12/95)  
LION'S COACH (09/95--)  
LION'S STAR (01/93-09/96)  
NG (--07/98)  
NL (--07/98)

NÜ (09/96-07/98)  
TGA (04/00--)  
TGS (09/07--)  
TGX (09/07--)  
ÜL (09/89-09/96)

**12-35 521 0012**  
81.50803.0044

**Brake disc**



**Notes**

	Internally Vented
Centering Diameter [mm]	106
Minimum Thickness [mm]	37
Outer Diameter [mm]	377
Height [mm]	111
Bolt Hole Circle Ø [mm]	144
Brake Disc Thickness [mm]	45
Number of Holes	12
	Rear Axle
	Front Axle

**References**

81.50803.0044
---------------

**Application info**

TGA (04/00--)

TGM (10/05--)

**12-35 521 0003**

81.50803.0048

**Brake disc**
**Notes**

	Vented
Centering Diameter [mm]	208
Minimum Thickness [mm]	35
Outer Diameter [mm]	432
Height [mm]	135
Bolt Hole Circle Ø [mm]	235
Brake Disc Thickness [mm]	45
Number of Holes	10
	Rear Axle

**References**

81.50803.0028	81.50803.0048
---------------	---------------

**Application info**

 LION'S COACH (09/95--)  
 LION'S STAR (01/93-09/96)

ÜL (09/89-09/96)

**12-35 521 0005**

81.50803.0057

**Brake disc**
**Notes**

	Vented
Centering Diameter [mm]	162
Minimum Thickness [mm]	38
Outer Diameter [mm]	376
Height [mm]	128
Bolt Hole Circle Ø [mm]	195
Brake System	KNORR SB/SN6
Brake Disc Thickness [mm]	45
Number of Holes	10
	Front Axle

**References**

81.50803.0020	81.50803.0057
81.50803.0027	

**Application info**

 M 2000 L (08/95--)  
 M 2000 M (--12/05)

TGM (10/05--)



2

**12-35 523 0000**  
81.50803.0061

**Brake disc**



**Notes**

Centering Diameter [mm]	157
Minimum Thickness [mm]	28
Outer Diameter [mm]	330
Height [mm]	124
Bolt Hole Circle Ø [mm]	180
Brake System	MERITOR
Brake Disc Thickness [mm]	34
Number of Holes	12
	Rear Axle

**References**

81.50803.0022	81.50803.0061
---------------	---------------

**Application info**

L 2000 (10/93-07/97)

**12-35 523 0005**  
81.50803.0062

**Brake disc**

**Notes**

Centering Diameter [mm]	154
Minimum Thickness [mm]	30
Outer Diameter [mm]	335
Height [mm]	118
Brake Disc Thickness [mm]	34
Number of Holes	10
	Rear Axle

**References**

81.50803.0043	81.50803.0062
---------------	---------------

**Application info**

L 2000 (10/93-07/97)

TGL (04/05--)

**025 290 9530**  
81.50820.5017

**Brake pad set**



**Notes**

Thickness [mm]	without add-on material
Height [mm]	prepared for wear indicator
Width [mm]	30
Brake System	92.5
	210.7
	Knorr
	Rear Axle
	Front Axle

**References**

81.50820.5017	81.50820.6022
81.50820.6008	

**Brake pad set**
**025 290 9530**  
 81.50820.5017

**Application info**

M 2000 L (08/95--)

M 2000 M (--12/05)

**Brake pad set**
**025 291 1428**  
 81.50820.6017

**Notes**

Thickness [mm]	30.2
Height [mm]	118.5
Width [mm]	249.6
Brake System	Meritor D-Elsa

**References**

81.50820.5007	81.50820.6001
81.50820.5041	81.50820.6003
81.50820.5048	81.50820.6005
81.50820.5061	81.50820.6015
81.50820.5069	81.50820.6017
81.50820.5092	81.50820.6026

**Application info**

 EL (01/93-06/97)  
 F 2000 (01/94-12/95)  
 F 90 (07/86-12/97)  
 LION'S COACH (09/95--)  
 LION'S COMFORT (09/96--)  
 LION'S STAR (01/93-09/96)  
 M 2000 L (08/95--)

 M 2000 M (--12/05)  
 NÜ (09/96-07/98)  
 TGA (04/00--)  
 TGS (09/07--)  
 TGX (09/07--)  
 ÜL (09/89-09/96)

**Brake pad set**
**025 290 8826**  
 81.50820.6020

**Notes**

Thickness [mm]	26
Height [mm]	85.6
Width [mm]	175.5
Brake System	Wabco PAN 17

**References**

81.50820.5023	81.50820.6006
81.50820.5025	81.50820.6020
81.50820.5029	81.50820.6042
81.50820.5079	

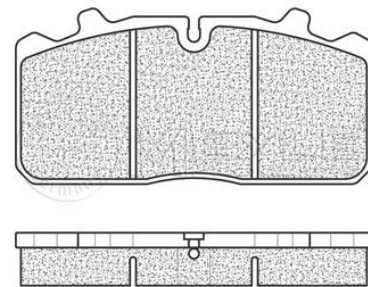
**Application info**

L 2000 (10/93-07/97)

M 2000 L (08/95--)



2

**025 290 8826/S**  
81.50820.6020

**Brake pad set**



**Notes**

Thickness [mm]  
Height [mm]  
Width [mm]  
Brake System

with add-on material  
prepared for wear indicator  
26  
85.6  
175.5  
Wabco PAN 17

**References**

81.50820.5023  
81.50820.5025  
81.50820.5029  
81.50820.5079

81.50820.6006  
81.50820.6020  
81.50820.6042

**Application info**

L 2000 (10/93-07/97)

M 2000 L (08/95--)

**025 290 8730**  
81.50820.6030

**Brake pad set**



**Notes**

Thickness [mm]  
Height [mm]  
Width [mm]  
Brake System

without accessories  
prepared for wear indicator  
30  
109.5  
247.3  
Knorr  
Rear Axle  
Front Axle

**References**

81.50820.6030

81.50820.6056

**Application info**

TGA (04/00--)  
TGS (09/07--)

TGX (09/07--)



**025 291 1328**  
 81.50820.6046

**Brake pad set**
**Notes**

without accessories  
 prepared for wear indicator

Thickness [mm] 28.2  
 Height [mm] 118.5  
 Width [mm] 249.6  
 Brake System TRW  
 Front Axle

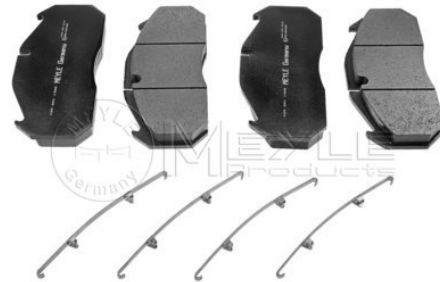
**References**

81.50820.5006	81.50820.6002
81.50820.5007	81.50820.6004
81.50820.5020	81.50820.6014
81.50820.5040	81.50820.6016
81.50820.5047	81.50820.6017
81.50820.5060	81.50820.6025
81.50820.5066	81.50820.6034
81.50820.5068	81.50820.6035
81.50820.5091	81.50820.6036
81.50820.6000	81.50820.6046

**Application info**

EL (01/93-06/97)  
 F 2000 (01/94-12/95)  
 F 90 (07/86-12/97)  
 LION'S COACH (09/95--)  
 LION'S COMFORT (09/96--)  
 LION'S STAR (01/93-09/96)

M 2000 L (08/95--)  
 M 2000 M (--12/05)  
 NÜ (09/96-07/98)  
 TGA (04/00--)  
 ÜL (09/89-09/96)

**025 291 3130**  
 81.50820.6051

**Brake pad set**
**Notes**

with add-on material  
 prepared for wear indicator

Thickness [mm] 30.2  
 Height [mm] 118.2  
 Width [mm] 249.6  
 Brake System Meritor D-Elsa 2  
 Front Axle

**References**

81.50820.5072	81.50820.6041
81.50820.5080	81.50820.6051
81.50820.6031	

**Application info**

TGA (04/00--)  
 TGS (09/07--)

TGX (09/07--)



2

**025 290 8730/S**  
81.50820.6056

**Brake pad set**



**Notes**

Thickness [mm]  
Height [mm]  
Width [mm]  
Brake System

with accessories  
prepared for wear indicator  
30  
109.5  
247.3  
Knorr  
Rear Axle  
Front Axle

**References**

81.50820.6030                      81.50820.6056

**Application info**

TGA (04/00--)

**025 290 4827**  
81.50820.6063

**Brake pad set**



**Notes**

Thickness [mm]  
Thickness [mm]  
Height [mm]  
Width [mm]  
Width [mm]  
Brake System

without add-on material  
excl. wear warning contact  
34  
27  
84  
185  
173.5  
Knorr SB 5000  
Front Axle

**References**

81.50820.5074                      81.50820.6043  
81.50820.5085                      81.50820.6054  
81.50820.6040                      81.50820.6063

**Application info**

TGL (04/05--)

**12-34 527 0001**  
81.50822.6016

**Wear sensor**



**Notes**

Warning Contact Length [mm]  
Required quantity

Disc Brake  
380  
2  
Left and right  
Front Axle

**References**

81.50822.6011                      81.50822.6016



## Wear sensor

**12-34 527 0001**  
 81.50822.6016

### Application info

 F 2000 (01/94-12/95)  
 LION'S COACH (09/95--)  
 LION'S STAR (01/93-09/96)  
 M 2000 L (08/95--)  
 M 2000 M (--12/05)

 NG (--07/98)  
 NÜ (09/96-07/98)  
 TGA (04/00--)  
 ÜL (09/89-09/96)

## ABS wheel sensor

**12-34 533 0103**  
 81.27120.0021

### Notes

	with accessories Inductive Sensor for vehicles with ABS
Cable Length [mm]	350
Operating voltage [V]	24
Length [mm]	400
Number of Poles	2
Required quantity	2
Resistance [Ohm]	1150
	Rear Axle Front Axle



### References

81.27120.0021

### Application info

 NG (--07/98)  
 NL (--07/98)

NM (--03/97)

## ABS wheel sensor

**12-34 899 0015**  
 81.27120.6105

### Notes

	with accessories Inductive Sensor for vehicles with ABS
Cable Length [mm]	2920
Operating voltage [V]	24
Length [mm]	3000
Number of Poles	2
Required quantity	2
Resistance [Ohm]	1150
	Rear Axle Front Axle



### References

81.27120.6105

### Application info

TGL (04/05--)

TGM (10/05--)



2

**12-34 899 0016**  
81.27120.6106

**ABS wheel sensor**



**Notes**

Cable Length [mm]  
Operating voltage [V]  
Length [mm]  
Number of Poles  
Required quantity  
Resistance [Ohm]

with accessories  
Inductive Sensor  
for vehicles with ABS  
2940  
24  
3000  
2  
2  
1150  
Rear Axle  
Front Axle

**References**

81.27120.6106

**Application info**

TGL (04/05--)

TGM (10/05--)

**12-34 533 0101**  
81.27120.6149

**ABS wheel sensor**



**Notes**

Cable Length [mm]  
Operating voltage [V]  
Length [mm]  
Number of Poles  
Required quantity  
Resistance [Ohm]

with accessories  
Passive sensor  
for vehicles with ABS  
2000  
24  
2090  
2  
1  
1150  
Front Axle

**References**

81.27120.6149

**Application info**

F 2000 (01/94-12/95)  
F 9 (01/83-12/86)  
G (10/79-08/88)  
M 2000 L (08/95--)  
M 2000 M (--12/05)  
M 90 (08/88-06/96)  
NG (--07/98)

NL (--07/98)  
NM (--03/97)  
R (05/85-01/93)  
SD (04/74-04/94)  
SL (05/80-04/87)  
SÜ (--06/97)  
ÜL (09/89-09/96)

**12-34 533 0100**  
 81.27120.6156

**ABS wheel sensor**
**Notes**

	with accessories Inductive Sensor for vehicles with ABS
Cable Length [mm]	2000
Operating voltage [V]	24
Length [mm]	2090
Number of Poles	2
Required quantity	1
Resistance [Ohm]	1150
	Rear Axle
	Front Axle

**References**

81.27120.6156

**Counterpart**

12-34 533 0102

**Application info**

 F 2000 (01/94-12/95)  
 L 2000 (10/93-07/97)  
 M 2000 L (08/95--)

 M 2000 M (--12/05)  
 M 90 (08/88-06/96)

**ABS wheel sensor**
**12-34 533 0102**  
 81.27120.6157

**Notes**

	with accessories Inductive Sensor for vehicles with ABS
Cable Length [mm]	2000
Operating voltage [V]	24
Length [mm]	2070
Number of Poles	2
Required quantity	1
Resistance [Ohm]	1750
	Rear Axle
	Front Axle

**References**

81.27120.6157

**Counterpart**

12-34 533 0100

**Application info**

 F 2000 (01/94-12/95)  
 L 2000 (10/93-07/97)  
 M 2000 L (08/95--)

 M 2000 M (--12/05)  
 M 90 (08/88-06/96)



2

**12-34 899 0014**  
81.27120.6164

**ABS wheel sensor**



**Notes**

Cable Length [mm]  
Operating voltage [V]  
Length [mm]  
Number of Poles  
Required quantity  
Resistance [Ohm]

with accessories  
Inductive Sensor  
for vehicles with ABS  
2080  
24  
2150  
2  
1  
1800  
Rear Axle  
Front Axle

**References**

81.27120.6110  
81.27120.6138

81.27120.6164

**Counterpart**

12-34 899 0013

**Application info**

TGA (04/00--)

**12-34 899 0013**  
81.27120.6165

**ABS wheel sensor**



**Notes**

Cable Length [mm]  
Operating voltage [V]  
Length [mm]  
Number of Poles  
Required quantity  
Resistance [Ohm]

with accessories  
Inductive Sensor  
for vehicles with ABS  
2090  
24  
2150  
2  
1  
1750  
Rear Axle  
Front Axle

**References**

81.27120.6137

81.27120.6165

**Counterpart**

12-34 899 0014

**Application info**

TGA (04/00--)

**12-34 899 0012**  
 81.27120.6168

**ABS wheel sensor**
**Notes**

	with accessories
	Inductive Sensor
	for vehicles with ABS
Cable Length [mm]	1750
Operating voltage [V]	24
Length [mm]	1800
Number of Poles	2
Required quantity	1
Resistance [Ohm]	1800
	Right
	Front Axle

**References**

81.27120.6126	81.27120.6168
---------------	---------------

**Counterpart**

12-34 899 0011

**Application info**

TGA (04/00-- )

**12-34 899 0011**  
 81.27120.6169

**ABS wheel sensor**
**Notes**

	with accessories
	Inductive Sensor
	for vehicles with ABS
Cable Length [mm]	1740
Operating voltage [V]	24
Length [mm]	1800
Number of Poles	2
Required quantity	1
Resistance [Ohm]	1800
	Left
	Front Axle

**References**

81.27120.6125	81.27120.6169
---------------	---------------

**Counterpart**

12-34 899 0012

**Application info**

TGA (04/00-- )



2

**12-34 899 0020**  
81.27120.6176

**ABS wheel sensor**



**Notes**

Cable Length [mm]  
Operating voltage [V]  
Length [mm]  
Number of Poles  
Required quantity  
Resistance [Ohm]

with accessories  
Inductive Sensor  
for vehicles with ABS  
1440  
24  
1500  
2  
1  
1150  
Front Axle Right

**References**

81.27120.6176

**Counterpart**

12-34 899 0021

**Application info**

TGA (04/00--)  
TGL (04/05--)  
TGM (10/05--)

TGS (09/07--)  
TGX (09/07--)

**12-34 899 0021**  
81.27120.6177

**ABS wheel sensor**



**Notes**

Cable Length [mm]  
Operating voltage [V]  
Length [mm]  
Number of Poles  
Required quantity  
Resistance [Ohm]

with accessories  
Inductive Sensor  
for vehicles with ABS  
1440  
24  
1500  
2  
1  
1150  
Front Axle Left

**References**

81.27120.6177

**Counterpart**

12-34 899 0020

**Application info**

TGA (04/00--)  
TGL (04/05--)  
TGM (10/05--)

TGS (09/07--)  
TGX (09/07--)



**12-34 899 0008**  
 81.27120.6178

**ABS wheel sensor**
**Notes**

	with accessories
	Inductive Sensor
	for vehicles with ABS
Cable Length [mm]	1220
Operating voltage [V]	24
Length [mm]	1300
Number of Poles	2
Required quantity	1
Resistance [Ohm]	1150
	Front Axle Right

**References**

81.27120.6178

**Counterpart**

12-34 899 0007

**Application info**

 LION'S COACH (09/95--)  
 LION'S STAR (01/93-09/96)

TGL (04/05--)

**12-34 899 0007**  
 81.27120.6179

**ABS wheel sensor**
**Notes**

	with accessories
	Inductive Sensor
	for vehicles with ABS
Cable Length [mm]	1240
Operating voltage [V]	24
Length [mm]	1300
Number of Poles	2
Required quantity	1
Resistance [Ohm]	1150
	Front Axle Left

**References**

81.27120.6179

**Counterpart**

12-34 899 0008

**Application info**

 LION'S COACH (09/95--)  
 LION'S STAR (01/93-09/96)

TGL (04/05--)

**12-34 899 0005**  
81.27120.6182

**ABS wheel sensor**



**Notes**

Cable Length [mm]  
Operating voltage [V]  
Length [mm]  
Number of Poles  
Required quantity  
Resistance [Ohm]

with accessories  
Inductive Sensor  
for vehicles with ABS  
2000  
24  
2065  
2  
1  
1150  
Rear Axle  
Front Axle

**References**

81.27120.6119

81.27120.6182

**Counterpart**

12-34 899 0006

**Application info**

LION'S COACH (09/95--)  
LION'S STAR (01/93-09/96)  
NM (--03/97)  
SÜ (--06/97)

TGA (04/00--)  
TGM (10/05--)  
TGS (09/07--)  
TGX (09/07--)

**12-34 899 0006**  
81.27120.6183

**ABS wheel sensor**



**Notes**

Cable Length [mm]  
Operating voltage [V]  
Length [mm]  
Number of Poles  
Required quantity  
Resistance [Ohm]

with accessories  
Inductive Sensor  
for vehicles with ABS  
2010  
24  
2065  
2  
1  
1150  
Rear Axle  
Front Axle

**References**

81.27120.6183

**Counterpart**

12-34 899 0005

**Application info**

LION'S COACH (09/95--)  
LION'S STAR (01/93-09/96)  
NM (--03/97)  
SÜ (--06/97)

TGA (04/00--)  
TGM (10/05--)  
TGS (09/07--)  
TGX (09/07--)

**12-34 899 0017**  
 81.27120.6184

**ABS wheel sensor**
**Notes**

	with accessories
	Inductive Sensor
	for vehicles with ABS
Cable Length [mm]	2600
Operating voltage [V]	24
Length [mm]	2670
Number of Poles	2
Required quantity	1
Resistance [Ohm]	1150
	Left

**References**

81.27120.6121	81.27120.6184
---------------	---------------

**Counterpart**

12-34 899 0018

**Application info**

TGA (04/00--)	TGS (09/07--)
---------------	---------------

**12-34 899 0018**  
 81.27120.6185

**ABS wheel sensor**
**Notes**

	Inductive Sensor
	for vehicles with ABS
Cable Length [mm]	2690
Operating voltage [V]	24
Length [mm]	2600
Number of Poles	2
Required quantity	1
Resistance [Ohm]	1150
	Front Axle Right

**References**

81.24120.6122	81.51101.6485
81.27120.6185	

**Counterpart**

12-34 899 0017

**Application info**

TGA (04/00--)	TGS (09/07--)
---------------	---------------



2

**12-34 899 0019**  
81.27120.6187

**ABS wheel sensor**



**Notes**

Cable Length [mm]  
Operating voltage [V]  
Length [mm]  
Number of Poles  
Required quantity  
Resistance [Ohm]

with accessories  
Inductive Sensor  
for vehicles with ABS  
2000  
24  
2070  
2  
2  
1150  
Rear Axle  
Front Axle

**References**

81.27120.6187

**Application info**

TGM (10/05--)

**12-34 899 0009**  
81.27120.6205

**ABS wheel sensor**



**Notes**

Cable Length [mm]  
Operating voltage [V]  
Length [mm]  
Number of Poles  
Required quantity  
Resistance [Ohm]

with accessories  
Inductive Sensor  
for vehicles with ABS  
2240  
24  
2300  
2  
1  
1150  
Rear Axle  
Front Axle

**References**

81.27120.6205

**Counterpart**

12-34 899 0010

**Application info**

TGM (10/05--)

**12-34 899 0010**  
 81.27120.6206

**ABS wheel sensor**
**Notes**

	with accessories
	Inductive Sensor
	for vehicles with ABS
Cable Length [mm]	2300
Operating voltage [V]	24
Length [mm]	2360
Number of Poles	2
Required quantity	1
Resistance [Ohm]	1150
	Rear Axle
	Front Axle

**References**

81.27120.6206

**Counterpart**

12-34 899 0009

**Application info**

TGM (10/05-- )

**Repair kit, brake shoe sleeve**
**034 042 0017**  
 81.50213.0013

**References**

81.50213.0013	81.50213.6006
81.50213.6005	

**Application info**

F 2000 (01/94-12/95)	M 90 (08/88-06/96)
F 90 (07/86-12/97)	TGL (04/05--)
F 90 Unterflur (07/86-05/94)	TGM (10/05--)
M 2000 L (08/95--)	TGS (09/07--)
M 2000 M (--12/05)	TGX (09/07--)



**034 042 0029/C**  
81.50610.6132

**Repair kit, brake adjuster**



**References**  
81.50610.6132

**Application info**

F 2000 (01/94-12/95)

F 90 (07/86-12/97)

**034 013 0006**  
51.54114.6054

**Cylinder head, compressor**



**References**

51.54114.6023	51.54114.6047
51.54114.6024	51.54114.6049
51.54114.6035	51.54114.6054
51.54114.6045	

**Application info**

E 2000 (05/00--)

TGA (04/00--)

**034 013 0008**  
81.54124.6006

**Valve plate, air compressor**



**References**

81.54124.6006



**Valve plate, air compressor**
**034 013 0008**  
 81.54124.6006

**Application info**

 E 2000 (05/00--)  
 F 2000 (01/94-12/95)  
 F 90 (07/86-12/97)  
 LION'S CITY (08/04--)  

 NG (--07/98)  
 NL (--07/98)  
 TGA (04/00--)  
**Valve plate, air compressor**
**12-14 013 0001**  
 81.54124.6013

**References**

81.54124.6013                      81.54124.6017

**Application info**

 F 2000 (01/94-12/95)  
 F 90 (07/86-12/97)  
 F 90 Unterflur (07/86-05/94)  
 NG (--07/98)  
 NL (--07/98)  

 NÜ (09/96-07/98)  
 SG (07/76-06/97)  
 SÜ (--06/97)  
 TGA (04/00--)  
 ÜL (09/89-09/96)  
**Cylinder liner, compressor**
**034 013 0001**  
 51.54105.6006

**Notes**

 Diameter [mm]                      with piston rings  
    with piston  
    90  
    Air cooled

**References**

51.54105.6006

**Application info**

 G 90 (09/87-05/95)  
 L 2000 (10/93-07/97)  
 M 2000 L (08/95--)  

 M 2000 M (--12/05)  
 M 90 (08/88-06/96)



2

**034 043 0056**  
81.52101.6275

**Silencer, compressor system**



**Notes**

Inner Diameter [mm] 40  
Outer Diameter [mm] 69

**References**

81.52101.6241 81.52101.6275  
81.52101.6246

**Application info**

F 2000 (01/94-12/95)  
M 90 (08/88-06/96)  
TGA (04/00--)  
TGL (04/05--)

TGM (10/05--)  
TGS (09/07--)  
TGX (09/07--)

**12-34 042 0026**  
81.52108.6025

**Air dryer cartridge**



**Notes**

Inner Thread [mm] M39x1,5  
Outer Diameter [mm] 141  
Height [mm] 165

**References**

81.52108.6001 81.52155.0040  
81.52108.6025 81.52155.0041

**Application info**

E 2000 (05/00--)  
EL (01/93-06/97)  
EM (08/87-06/97)  
F 2000 (01/94-12/95)  
L 2000 (10/93-07/97)  
LION'S COACH (09/95--)  
LION'S COMFORT (09/96--)  
LION'S STAR (01/93-09/96)  
M 2000 L (08/95--)  
M 2000 M (--12/05)  
NG (--07/98)

NL (--07/98)  
NM (--03/97)  
NÜ (09/96-07/98)  
SL II (--04/94)  
SM (11/87-02/95)  
SÜ (--06/97)  
TGA (04/00--)  
TGL (04/05--)  
TGM (10/05--)  
TGS (09/07--)  
TGX (09/07--)



**034 042 0032**  
 82.52102.0013

**Air dryer cartridge**
**Notes**

Inner Thread [mm] M39x1,5  
 Outer Diameter [mm] 140  
 Height [mm] 164

**References**

81.52102.0008 82.52102.0013

**Application info**

CLA (01/06--)

**Air suspension valve**
**12-34 032 0000**  
 81.43610.6129

**Notes**

Left and right

**References**

81.43610.6124 81.43610.6129

**Application info**

F 2000 (01/94-12/95)  
 F 90 (07/86-12/97)  
 M 90 (08/88-06/96)

TGA (04/00--)  
 TGS (09/07--)  
 TGX (09/07--)

**Sensor, pneumatic suspension level**
**12-34 032 0007**  
 81.25937.0015

**References**

81.25937.0010 81.25937.0015

**Application info**

F 90 (07/86-12/97)

M 90 (08/88-06/96)



2

**834 533 0004**  
81.25937.0016

**Sensor, pneumatic suspension level**



**References**  
81.25937.0016

**Application info**

F 2000 (01/94-12/95)

M 2000 M (--12/05)

**034 042 0033**  
81.51220.6024

**Brake line coupling**



**Notes**

Number of ports	Red
Port Thread	1
Operating Pressure [bar]	M22x1,5
	8.2

**References**

81.51220.6024

**Counterpart**

034 042 0034

**Application info**

F 2000 (01/94-12/95)

**034 042 0034**  
81.51220.6025

**Brake line coupling**



**Notes**

Number of ports	Yellow
Port Thread	1
Operating Pressure [bar]	M22x1,5
	8

**References**

81.51220.6025

**Counterpart**

034 042 0033

**Application info**

F 2000 (01/94-12/95)

## Brake line coupling

**034 042 0039**

81.51220.6069

### Notes

Number of ports	Yellow
Port Thread	1
Operating Pressure [bar]	M16x1,5
	8.1

### References

81.51220.6032	81.51220.6093
81.51220.6069	81.51220.6096

### Counterpart

034 042 0038



### Application info

F 2000 (01/94-12/95)

## Overflow valve

**12-35 533 0003**

81.52110.6049

### References

81.52110.6049	81.52110.6095
---------------	---------------



### Application info

 F 2000 (01/94-12/95)  
 F 90 (07/86-12/97)  
 L 2000 (10/93-07/97)  
 M 2000 L (08/95--)  
 M 2000 M (--12/05)

 M 90 (08/88-06/96)  
 TGA (04/00--)  
 TGL (04/05--)  
 TGM (10/05--)

## Quick release valve

**034 042 0048**

90.81011.4192

### References

81.52115.6009	81.52115.6021
81.52115.6017	90.81011.4192
81.52115.6018	





**034 042 0048**  
90.81011.4192

**Quick release valve**

**+** Application info  
G 90 (09/87-05/95)

**12-35 533 0000**  
81.52101.6153

**Pressure limiting valve**



**Notes**

Pressure [bar] 3.5

**References**

81.52101.6153 81.52101.6154

**Application info**

- |                      |                  |
|----------------------|------------------|
| EL (01/93-06/97)     | SG (07/76-06/97) |
| EM (08/87-06/97)     | SL II (--04/94)  |
| F 2000 (01/94-12/95) | SM (11/87-02/95) |
| F 90 (07/86-12/97)   | SÜ (--06/97)     |
| L 2000 (10/93-07/97) | TGA (04/00--)    |
| M 2000 L (08/95--)   | TGL (04/05--)    |
| M 2000 M (--12/05)   | TGM (10/05--)    |
| NG (--07/98)         | TGS (09/07--)    |
| NL (--07/98)         | TGX (09/07--)    |
| NM (--03/97)         | ÜL (09/89-09/96) |
| NÜ (09/96-07/98)     |                  |

**12-35 533 0001**  
81.52101.6269

**Pressure limiting valve**



**References**

81.52101.6269



**Pressure limiting valve**
**12-35 533 0001**  
 81.52101.6269

**Application info**

F 2000 (01/94-12/95)	NL (--07/98)
L 2000 (10/93-07/97)	NÜ (09/96-07/98)
LION'S COACH (09/95--)	TGA (04/00--)
LION'S STAR (01/93-09/96)	TGL (04/05--)
M 2000 L (08/95--)	TGM (10/05--)
M 2000 M (--12/05)	TGS (09/07--)
NG (--07/98)	TGX (09/07--)

**Pressure limiting valve**
**12-35 533 0002**  
 81.52101.6270

**References**

81.52101.6270

**Application info**

EM (08/87-06/97)	M 2000 M (--12/05)
F 2000 (01/94-12/95)	NM (--03/97)
L 2000 (10/93-07/97)	TGA (04/00--)
LION'S COACH (09/95--)	TGL (04/05--)
LION'S STAR (01/93-09/96)	

**Line filter, compressor system**
**034 042 0024**  
 81.51270.6002

**Notes**

Pressure [bar]                      8

**References**

81.51270.6002

**Application info**

G (10/79-08/88)	M 90 (08/88-06/96)
M 2000 L (08/95--)	TGA (04/00--)
M 2000 M (--12/05)	TGM (10/05--)



2

**034 043 0005**  
81.15701.6003

**Slave cylinder**



**Notes**

Diameter [mm] 35  
Thread Size M18x1

**References**  
81.15701.6003

**Application info**  
F 2000 (01/94-12/95) F 90 (07/86-12/97)

**12-34 157 0008**  
81.15701.6079

**Slave cylinder**



**Notes**

Diameter [mm] 40  
Thread Size M8x1

**References**  
81.15700.6006 81.15701.6079  
81.15700.9006

**Application info**  
G 90 (09/87-05/95) SÜ (-06/97)  
SR (10/75-11/86)

**12-34 157 0003**  
81.15701.6112

**Slave cylinder**



**Notes**

Diameter [mm] 50  
Thread Size M10x1

**References**  
81.15701.6112

+

## Slave cylinder

**12-34 157 0003**  
 81.15701.6112

### Application info

EM (08/87-06/97)	NG (--07/98)
F 2000 (01/94-12/95)	NL (--07/98)
F 90 (07/86-12/97)	NM (--03/97)
F 90 Unterflur (07/86-05/94)	NÜ (09/96-07/98)
L 2000 (10/93-07/97)	R (05/85-01/93)
LION'S COACH (09/95--)	SM (11/87-02/95)
LION'S STAR (01/93-09/96)	SÜ (--06/97)
M 2000 L (08/95--)	TGA (04/00--)
M 2000 M (--12/05)	ÜL (09/89-09/96)

## Slave cylinder

**12-34 157 0007**  
 81.15701.6119

### Notes

Diameter [mm]	44
Thread Size	M8x1

### References

81.15701.6091	81.15701.6116
81.15701.6099	81.15701.6119



### Application info

F 2000 (01/94-12/95)	NL (--07/98)
F 90 (07/86-12/97)	TGA (04/00--)
LION'S CITY (08/04--)	ÜL (09/89-09/96)
M 90 (08/88-06/96)	

## Slave cylinder

**12-34 157 0005**  
 81.15701.6120

### Notes

Diameter [mm]	48
Thread Size	M8x1

### References

81.15701.6113	81.15701.6120
---------------	---------------



### Application info

CLA (01/06--)	M 90 (08/88-06/96)
EL (01/93-06/97)	NG (--07/98)
F 2000 (01/94-12/95)	NL (--07/98)
L 2000 (10/93-07/97)	NÜ (09/96-07/98)
M 2000 L (08/95--)	TGA (04/00--)
M 2000 M (--12/05)	



2

**12-34 157 0004**  
81.15701.6124

**Slave cylinder**



**Notes**

Diameter [mm] 45  
Thread Size M8x1

**References**

81.15701.6124

**Application info**

TGA (04/00--)  
TGL (04/05--)  
TGM (10/05--)

TGS (09/07--)  
TGX (09/07--)

**12-35 533 0034**  
81.52151.6094

**Multi-circuit protection valve**



**Notes**

Thread Size M18x1,5

**References**

81.52151.6094

**Application info**

TGA (04/00--)  
TGS (09/07--)

TGX (09/07--)

**12-35 533 0005**  
81.52151.6096

**Multi-circuit protection valve**



**Notes**

Thread Size M22x1,5  
Thread Size M16x1,5

**References**

81.52151.6093                      81.52151.6096





**Multi-circuit protection valve**
**12-35 533 0005**  
 81.52151.6096

**Application info**

F 2000 (01/94-12/95)

TGA (04/00--)

**Check valve**
**034 042 0051**  
 81.52120.6029

**Notes**

Non-return Valve

**References**

81.52120.6003	81.52120.6030
81.52120.6004	81.52120.6040
81.52120.6025	81.52120.6075
81.52120.6028	85.30001.6535
81.52120.6029	88.52120.6200

**Application info**

 EL (01/93-06/97)  
 EM (08/87-06/97)  
 F 2000 (01/94-12/95)  
 F 90 (07/86-12/97)  
 F 90 Unterflur (07/86-05/94)  
 G (10/79-08/88)  
 G 90 (09/87-05/95)  
 L 2000 (10/93-07/97)  
 LION'S COACH (09/95--)  
 LION'S STAR (01/93-09/96)  
 M 2000 L (08/95--)  
 M 2000 M (--12/05)  
 M 90 (08/88-06/96)  
 NG (--07/98)

 NL (--07/98)  
 NM (--03/97)  
 NÜ (09/96-07/98)  
 R (05/85-01/93)  
 SD (04/74-04/94)  
 SG (07/76-06/97)  
 SL II (--04/94)  
 SM (11/87-02/95)  
 SÜ (--06/97)  
 TGA (04/00--)  
 TGL (04/05--)  
 TGM (10/05--)  
 ÜL (09/89-09/96)

**Control valve, trailer**
**12-35 533 0007**  
 81.52301.6189

**References**

81.52301.6183	81.52301.6192
81.52301.6189	

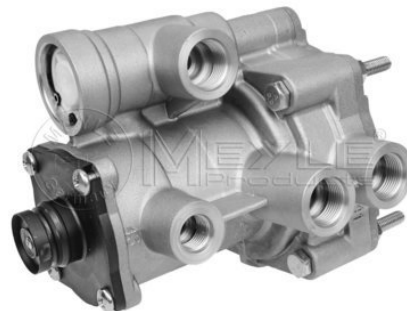



**12-35 533 0007**  
81.52301.6189

**Control valve, trailer**

**Application info**

F 2000 (01/94-12/95)  
L 2000 (10/93-07/97)  
M 2000 L (08/95--)  
M 2000 M (--12/05)

NG (--07/98)  
TGA (04/00--)  
TGL (04/05--)  
TGM (10/05--)

**12-35 533 0037**  
81.52310.6165

**Control valve, trailer**



**References**

81.52301.6120                      81.52310.6165  
81.52301.6121

**Application info**

F 90 (07/86-12/97)

**12-34 043 0002**  
81.52301.6148

**Brake valve, park brake**



**References**

81.52301.6148                      82.58000.0060  
81.52301.9148

**Application info**

TGA (04/00--)

**12-35 533 0031**  
 81.52315.6156

**Brake valve, park brake**
**Notes**

 Thread Size M16x1,5  
 Operating Pressure [bar] 10

**References**

 81.52315.6156 81.52315.6161  
 81.52315.6160

**Application info**

 CLA (01/06--)  
 F 2000 (01/94-12/95)  
 M 2000 M (--12/05)

 TGA (04/00--)  
 TGL (04/05--)

**Diaphragm, brake cylinder**
**034 043 0002**  
 81.51113.0001

**Notes**

 Equipment Variant T20  
 Diameter [in] Rubber with textile reinforcement 20"

**References**

81.51113.0001

**Application info**

M 90 (08/88-06/96)

TGA (04/00--)

**Diaphragm, brake cylinder**
**034 042 0061**  
 81.51113.0012

**Notes**

 Equipment Variant T16L  
 Diameter [in] Rubber with textile reinforcement 16"

**References**

81.51113.0012

**Application info**

F 90 (07/86-12/97)



2

<p><b>034 042 0030</b> 81.51113.0013</p>		<p><b>Diaphragm, brake cylinder</b></p>					
		<p><b>Notes</b></p> <table border="0"> <tr> <td>Equipment Variant</td> <td>T16</td> </tr> <tr> <td>Diameter [in]</td> <td>Rubber with textile reinforcement 16"</td> </tr> </table> <p><b>References</b> 81.51113.0013</p>		Equipment Variant	T16	Diameter [in]	Rubber with textile reinforcement 16"
Equipment Variant	T16						
Diameter [in]	Rubber with textile reinforcement 16"						

**Application info**  
TGA (04/00--)

<p><b>034 042 0043</b> 81.51113.0014</p>		<p><b>Diaphragm, brake cylinder</b></p>					
		<p><b>Notes</b></p> <table border="0"> <tr> <td>Equipment Variant</td> <td>T24L</td> </tr> <tr> <td>Diameter [in]</td> <td>Rubber with textile reinforcement 24"</td> </tr> </table> <p><b>References</b> 81.51113.0014                      99.10036.0792</p>		Equipment Variant	T24L	Diameter [in]	Rubber with textile reinforcement 24"
Equipment Variant	T24L						
Diameter [in]	Rubber with textile reinforcement 24"						

**Application info**  
F 90 (07/86-12/97)                      TGA (04/00--)

<p><b>034 042 0062</b> 81.51113.0020</p>		<p><b>Diaphragm, brake cylinder</b></p>					
		<p><b>Notes</b></p> <table border="0"> <tr> <td>Equipment Variant</td> <td>T20L</td> </tr> <tr> <td>Diameter [in]</td> <td>Rubber with textile reinforcement 20"</td> </tr> </table> <p><b>References</b> 81.51113.0020</p>		Equipment Variant	T20L	Diameter [in]	Rubber with textile reinforcement 20"
Equipment Variant	T20L						
Diameter [in]	Rubber with textile reinforcement 20"						

**Application info**  
F 90 (07/86-12/97)

**034 042 0001**  
 90.91157.8013

**Diaphragm, brake cylinder**
**Notes**

Equipment Variant T24  
 Rubber with textile reinforcement  
 Diameter [in] 24"

**References**

90.91157.8013

**Application info**

EL (01/93-06/97)  
 EM (08/87-06/97)  
 F 2000 (01/94-12/95)  
 F 90 (07/86-12/97)  
 F 90 Unterflur (07/86-05/94)  
 G (10/79-08/88)

G 90 (09/87-05/95)  
 L 2000 (10/93-07/97)  
 LION'S COACH (09/95--)  
 LION'S COMFORT (09/96--)  
 LION'S STAR (01/93-09/96)  
 TGA (04/00--)

**Diaphragm, brake cylinder**
**034 042 0003**  
 90.91159.0013

**Notes**

Equipment Variant T30  
 Rubber with textile reinforcement  
 Diameter [in] 30"

**References**

90.91159.0013

**Application info**

L 2000 (10/93-07/97)

TGA (04/00--)

**Diaphragm, brake cylinder**
**034 042 0002**
**Notes**

Equipment Variant T30L  
 Rubber with textile reinforcement  
 Diameter [in] 30"





**034 042 0002**

**Diaphragm, brake cylinder**

**Application info**  
TGA (04/00--)

**12-34 026 0002**  
81.52131.6015

**Valve, compressor system**



**Notes**  
Multiport Valve

**References**  
81.52131.6015                      81.52170.6151  
81.52170.6139

**Application info**  
F 2000 (01/94-12/95)  
F 90 (07/86-12/97)

F 90 Unterflur (07/86-05/94)  
M 90 (08/88-06/96)

**034 026 0027**  
81.52170.6128

**Valve, compressor system**



**Notes**  
Relay Valve

**References**  
81.52170.6064                      81.52170.6128

**Application info**  
F 2000 (01/94-12/95)  
F 90 (07/86-12/97)  
M 2000 L (08/95--)

M 2000 M (--12/05)  
M 90 (08/88-06/96)

**034 042 0007**  
 81.52116.6037

**Relay valve**
**Notes**

Pressure [bar]	10
Thread Size	M16x1,5
Thread Size	M22x1,5
Number of Inlets / Outlets	3

**References**

81.52116.6010	81.52116.6037
---------------	---------------

**Application info**

F 90 (07/86-12/97)	M 90 (08/88-06/96)
F 90 Unterflur (07/86-05/94)	

**12-34 043 0001**  
 81.52116.6069

**Relay valve**
**Notes**

Pressure [bar]	8
Thread Size	M16x1,5
Thread Size	M22x1,5
Number of Inlets / Outlets	4

**References**

81.52116.6067	81.52116.6069
81.52116.6068	

**Application info**

TGA (04/00--)

**034 043 0070**  
 81.52116.6070

**Relay valve**
**Notes**

Pressure [bar]	13
Thread Size	M22x1,5
Thread Size	M16x1,5
Number of Inlets / Outlets	4

**References**

81.52116.6070





**034 043 0070**  
81.52116.6070

**Relay valve**

**Application info**

EM (08/87-06/97)  
F 2000 (01/94-12/95)  
L 2000 (10/93-07/97)  
LION'S COACH (09/95--)  
LION'S STAR (01/93-09/96)  
M 2000 L (08/95--)  
M 2000 M (--12/05)

NG (--07/98)  
NL (--07/98)  
NM (--03/97)  
NÜ (09/96-07/98)  
TGA (04/00--)  
ÜL (09/89-09/96)

**12-35 533 0004**  
81.52116.6071

**Relay valve**



**Notes**

Pressure [bar]	10
Thread Size	M22x1,5
Thread Size	M16x1,5
Number of Inlets / Outlets	5

**References**

81.52116.6071

**Application info**

F 2000 (01/94-12/95)  
L 2000 (10/93-07/97)  
LION'S COACH (09/95--)  
LION'S STAR (01/93-09/96)  
M 2000 M (--12/05)

NG (--07/98)  
NL (--07/98)  
NÜ (09/96-07/98)  
TGA (04/00--)  
ÜL (09/89-09/96)

**034 043 0066**  
81.52116.6074

**Relay valve**



**Notes**

Pressure [bar]	8.5
Thread Size	M22x1,5
Number of Inlets / Outlets	5

**References**

81.52116.6074	81.52116.9075
81.52116.6075	

**Application info**

L 2000 (10/93-07/97)  
LION'S COACH (09/95--)  
LION'S STAR (01/93-09/96)  
M 2000 L (08/95--)  
M 2000 M (--12/05)

NG (--07/98)  
NÜ (09/96-07/98)  
TGA (04/00--)  
TGL (04/05--)  
TGM (10/05--)



**Multiway valve**
**034 026 0030**  
 81.32734.6001

**Notes**

Pressure [bar] 8.1

**References**

81.32734.6001 81.52170.6120

**Application info**

 F 2000 (01/94-12/95) M 90 (08/88-06/96)  
 F 90 (07/86-12/97)

**Multiway valve**
**12-37 142 0007**  
 81.52170.6156

**References**

81.52170.6096 81.52170.6156

**Application info**

 F 2000 (01/94-12/95) M 2000 L (08/95--)  
 F 90 (07/86-12/97) M 2000 M (--12/05)  
 F 90 Unterflur (07/86-05/94) M 90 (08/88-06/96)  
 LION'S COACH (09/95--)



3

**12-34 279 0073**

06.56279.0073

**Shaft seal, differential**



**Notes**

	FPM (fluoride rubber)
Inner Diameter [mm]	72
Outer Diameter [mm]	105
Height [mm]	13

**References**

06.56279.0027	06.56279.0073
06.56279.0072	81.96501.0907

**Application info**

F 90 (07/86-12/97)	M 2000 L (08/95--)
L 2000 (10/93-07/97)	M 2000 M (--12/05)

**12-14 753 0001**

06.56279.0366

**Shaft seal, differential**



**Notes**

	FPM (fluoride rubber)
Inner Diameter [mm]	72
Outer Diameter [mm]	105
Height [mm]	13
	inner

**References**

06.56279.0366
---------------

**Application info**

F 2000 (01/94-12/95)	M 2000 L (08/95--)
F 90 (07/86-12/97)	M 2000 M (--12/05)
G 90 (09/87-05/95)	M 90 (08/88-06/96)
L 2000 (10/93-07/97)	TGA (04/00--)

**12-14 753 0013**

06.56289.0293

**Shaft seal, differential**



**Notes**

	FPM (fluoride rubber)
Inner Diameter [mm]	80
Outer Diameter [mm]	154
Outer Diameter [mm]	135
Height [mm]	12

**References**

06.56289.0279	81.96502.6052
06.56289.0280	81.96502.6066
06.56289.0293	



**Shaft seal, differential**
**12-14 753 0013**  
 06.56289.0293

**Application info**

 F 2000 (01/94-12/95)  
 F 90 (07/86-12/97)  
 L 2000 (10/93-07/97)  
 LION'S COACH (09/95--)  
 LION'S STAR (01/93-09/96)

 M 2000 L (08/95--)  
 M 2000 M (--12/05)  
 M 90 (08/88-06/96)  
 TGA (04/00--)  
 ÜL (09/89-09/96)

**Shaft seal, differential**
**12-14 753 0014**  
 06.56289.0319

**Notes**

	FPM (fluoride rubber)/ACM (polyacrylate rubber)
Inner Diameter [mm]	85
Outer Diameter [mm]	145
Height [mm]	37

**References**

06.56289.0319	81.35412.6003
---------------	---------------

**Application info**

 F 2000 (01/94-12/95)  
 F 90 (07/86-12/97)  
 F 90 Unterflur (07/86-05/94)  
 M 2000 L (08/95--

 TGA (04/00--)  
 TGS (09/07--)  
 TGX (09/07--

**Shaft seal, differential**
**034 753 0021**  
 06.56289.0361

**Notes**

	NBR (nitrile butadiene rubber)
Inner Diameter [mm]	85
Outer Diameter [mm]	105
Height [mm]	13

**References**

06.56289.0361

**Application info**

 E 2000 (05/00--)  
 F 2000 (01/94-12/95)  
 F 90 (07/86-12/97)

 F 90 Unterflur (07/86-05/94)  
 TGA (04/00--



3

**036 026 0016**

81.95301.0045

**Shift rod connector**



**Notes**

Thread Measurement 2	with right-hand thread
Thread Measurement 1	M14x1,5
Length [mm]	M10x1
Cone Size [mm]	86
	12

**References**

81.95301.0045	81.95301.6176
81.95301.6016	81.95301.6266
81.95301.6169	81.95301.6269
81.95301.6172	

**Application info**

F 90 Unterflur (07/86-05/94)  
 M 2000 L (08/95--)  
 M 2000 M (--12/05)  
 M 90 (08/88-06/96)  
 R (05/85-01/93)

SG (07/76-06/97)  
 SL (05/80-04/87)  
 SR (10/75-11/86)  
 SÜ (--06/97)

**034 026 0018**

81.95301.6170

**Shift rod connector**



**Notes**

Thread Measurement 2	with right-hand thread
Thread Measurement 1	M12x1,75
Length [mm]	M10x1,5
Cone Size [mm]	55
	10.8

**References**

81.95301.6064	81.95301.6170
81.95301.6130	81.95301.6173

**Counterpart**

034 026 0017

**Application info**

EL (01/93-06/97)  
 EM (08/87-06/97)  
 F 2000 (01/94-12/95)  
 F 90 (07/86-12/97)  
 F 90 Unterflur (07/86-05/94)  
 G (10/79-08/88)  
 G 90 (09/87-05/95)  
 L 2000 (10/93-07/97)  
 LION'S COACH (09/95--)  
 LION'S COMFORT (09/96--)  
 LION'S STAR (01/93-09/96)  
 M 2000 L (08/95--)  
 M 2000 M (--12/05)  
 M 90 (08/88-06/96)  
 NG (--07/98)

NL (--07/98)  
 NM (--03/97)  
 NÜ (09/96-07/98)  
 R (05/85-01/93)  
 SD (04/74-04/94)  
 SG (07/76-06/97)  
 SL (05/80-04/87)  
 SM (11/87-02/95)  
 SR (10/75-11/86)  
 SÜ (--06/97)  
 TGA (04/00--)  
 TGL (04/05--)  
 TGM (10/05--)  
 ÜL (09/89-09/96)

**034 026 0017**

81.95301.6171

**Shift rod connector**
**Notes**

	with left-hand thread
Thread Measurement 2	M12x1,75
Thread Measurement 1	M10x1,5
Length [mm]	55
Cone Size [mm]	12.8

**References**

81.95301.6063	81.95301.6171
81.95301.6131	81.95301.6174

**Counterpart**

034 026 0018

**Application info**

 F 2000 (01/94-12/95)  
 F 90 (07/86-12/97)  
 F 90 Unterflur (07/86-05/94)  
 L 2000 (10/93-07/97)

 M 90 (08/88-06/96)  
 TGL (04/05--)  
 TGM (10/05--)
**Shift rod connector**
**034 026 0015**

81.95301.6235

**Notes**

	with right-hand thread
Thread Measurement 2	M14x1,5
Thread Measurement 1	M10x1
Length [mm]	88
Cone Size [mm]	12

**References**

81.95301.0038	81.95301.6172
81.95301.6016	81.95301.6176
81.95301.6169	81.95301.6235

**Application info**

 F 90 Unterflur (07/86-05/94)  
 M 90 (08/88-06/96)  
 R (05/85-01/93)  
 SG (07/76-06/97)

 SL (05/80-04/87)  
 SR (10/75-11/86)  
 SÜ (--06/97)
**Switch, splitter gearbox**
**034 026 0032**

81.32550.0003

**Notes**

Number of ports 3

**References**

81.32550.0003





**034 026 0032**  
81.32550.0003

**Switch, splitter gearbox**

**+** Application info  
F 90 (07/86-12/97)

**034 026 0029**  
81.52170.6095

**Switch, splitter gearbox**



<b>Notes</b>	
Number of ports	2
<b>References</b>	
81.52170.6095	81.52170.6097

**Application info**  
F 90 (07/86-12/97)

**14-34 043 0001**  
85.32734.6001

**Switch, splitter gearbox**

<b>References</b>	
85.30001.9636	85.32734.6001

**Application info**  
F 2000 (01/94-12/95)

3

**034 026 0025**

81.32735.6040

**Neutral safety switch**
**Notes**

Operating Pressure [bar]	Pneumatic 8
--------------------------	----------------

**References**

81.32735.6011	81.32735.6039
81.32735.6035	81.32735.6040

**Application info**

M 90 (08/88-06/96)

**12-34 410 0002**

81.39410.6019

**Drive shaft support**
**Notes**

Thickness [mm]	90
Thickness [mm]	70
Inner Diameter [mm]	65
Outer Diameter [mm]	185
	with ball bearing
	Centre

**References**

81.39410.6013	81.39410.6019
81.39410.6017	

**Application info**

F 2000 (01/94-12/95)	TGA (04/00--)
F 90 (07/86-12/97)	TGL (04/05--)
L 2000 (10/93-07/97)	TGM (10/05--)
M 2000 L (08/95--)	TGS (09/07--)
M 2000 M (--12/05)	TGX (09/07--)
M 90 (08/88-06/96)	

**Drive shaft support**
**12-34 151 0002**

81.39410.6020

**Notes**

Thickness [mm]	60
Thickness [mm]	40
Inner Diameter [mm]	75
Outer Diameter [mm]	180
	with ball bearing
	Centre

**References**

81.39410.6020





**12-34 151 0002**

81.39410.6020

**Drive shaft support**

**Application info**

TGA (04/00--)

**12-34 151 0003**

81.39410.6031

**Drive shaft support**



**Notes**

Thickness [mm]	60
Thickness [mm]	40
Inner Diameter [mm]	85
Outer Diameter [mm]	180
	with ball bearing
	Centre

**References**

81.39410.6023	81.39410.6031
---------------	---------------

**Application info**

F 2000 (01/94-12/95)	NÜ (09/96-07/98)
F 90 (07/86-12/97)	SD (04/74-04/94)
G 90 (09/87-05/95)	SG (07/76-06/97)
L 2000 (10/93-07/97)	SR (10/75-11/86)
M 2000 L (08/95--)	SÜ (--06/97)
M 2000 M (--12/05)	TGL (04/05--)
M 90 (08/88-06/96)	TGM (10/05--)
NG (--07/98)	TGS (09/07--)
NL (--07/98)	TGX (09/07--)
NM (--03/97)	ÜL (09/89-09/96)

**034 041 9022**

81.39108.6048

**Joint, propeller shaft**



**Notes**

	Piece with add-on material
	Universal Joint
Outer Diameter [mm]	57
Length [mm]	152
	Centre

**References**

81.39108.6048	81.39374.6003
---------------	---------------

**Application info**

F 2000 (01/94-12/95)	TGA (04/00--)
LION'S COACH (09/95--)	TGL (04/05--)
LION'S STAR (01/93-09/96)	TGM (10/05--)
M 2000 L (08/95--)	



**12-34 126 6017**

81.39126.6017

**Joint, propeller shaft**
**Notes**

Piece  
with add-on material  
Universal Joint

Outer Diameter [mm] 57  
Length [mm] 144  
Centre

**References**

81.39126.6017 81.39200.6015

**Application info**

F 90 (07/86-12/97) L 2000 (10/93-07/97)  
F 90 Unterflur (07/86-05/94)

**12-34 126 6020**

81.39126.6030

**Joint, propeller shaft**
**Notes**

Piece  
with add-on material  
Universal Joint

Outer Diameter [mm] 52  
Length [mm] 148  
Centre

**References**

81.39126.6020 81.99917.8470  
81.39126.6030

**Application info**

F 2000 (01/94-12/95) TGS (09/07--)  
F 90 (07/86-12/97) TGX (09/07--)  
TGA (04/00--)

**12-31 106 6032**

81.30550.0050

**Release bearing**
**Notes**

Parameter KZIS-4  
Height [mm] 55

**References**

81.30550.0041 81.30550.6019  
81.30550.0050





**12-31 106 6032**

81.30550.0050

**Release bearing**

**+** Application info  
M 90 (08/88-06/96)

**12-31 106 0003**

81.30560.0075

**Release fork, clutch**



**References**

81.30560.0070

81.30560.0075

**Application info**

TGL (04/05--)

**12-31 106 0002**

81.32411.0007

**Release fork, clutch**



**References**

81.32411.0006

81.32411.0007

**Parts list**

12-31 106 0001

Repair kit, clutch releaser

**Application info**

F 2000 (01/94-12/95)  
F 90 (07/86-12/97)

TGA (04/00--)

3

**12-31 106 0005**

81.93021.0424

**Release fork, clutch**
**References**

81.30560.0067	81.30560.6024
81.30560.0068	81.32411.0009
81.30560.0078	81.93021.0424
81.30560.6023	N2.93021.0137

**Parts list**

12-31 106 0006	Repair kit, clutch releaser
----------------	-----------------------------

**Application info**

TGL (04/05--)

**Repair kit, clutch releaser**
**034 600 6000**

81.30300.6002

**References**

81.30300.6002	81.30300.6003
---------------	---------------

**Application info**

F 2000 (01/94-12/95)	TGM (10/05--)
M 2000 L (08/95--)	TGS (09/07--)
TGA (04/00--)	TGX (09/07--)
TGL (04/05--)	

**Repair kit, clutch releaser**
**12-31 106 0001**

81.30560.6019

**Notes**

with pressure pin

**References**

81.30560.6019	81.30560.6022
---------------	---------------





**12-31 106 0001**  
81.30560.6019

**Repair kit, clutch releaser**

**Application info**  
F 2000 (01/94-12/95)  
F 90 (07/86-12/97)

TGA (04/00--)

**12-31 106 0006**  
81.95302.0079

**Repair kit, clutch releaser**



**References**

81.95302.0079

81.95302.0080

**Application info**  
TGL (04/05--)

**12-31 106 0004**  
81.30530.0037

**Bolt, release fork**



**References**

81.30530.0037

**Application info**  
TGA (04/00--)  
TGL (04/05--)

TGM (10/05--)

3

**12-34 725 6025**  
 81.30725.6026

**Clutch booster**
**Notes**

Force output F [N]	Brake Fluid
Stroke [mm]	4000
	85

**References**

81.30725.6007	81.30725.6026
81.30725.6024	81.30725.9025
81.30725.6025	

**Application info**

SL II (-04/94)	SÜ (-06/97)
----------------	-------------

**12-34 725 6027**  
 81.30725.6027

**Clutch booster**
**Notes**

Force output F [N]	Brake Fluid
Stroke [mm]	4000
	85

**References**

81.30725.6027	81.30725.6045
81.30725.6028	81.30725.6046

**Application info**

M 90 (08/88-06/96)

**12-34 725 6032**  
 81.30725.6053

**Clutch booster**
**Notes**

Force output F [N]	Brake Fluid
Operating Pressure [bar]	6000
Stroke [mm]	8.1
	85

**References**

81.30725.6031	81.30725.6053
81.30725.6032	81.30725.6054

**Application info**

F 90 (07/86-12/97)	SÜ (-06/97)
F 90 Unterflur (07/86-05/94)	



3

**12-37 142 0003**  
81.30725.6065

**Clutch booster**



**Notes**

Force output F [N]	6000
Operating Pressure [bar]	8.2
Stroke [mm]	85

**References**

81.30725.6065	81.30725.6086
---------------	---------------

**Application info**

F 2000 (01/94-12/95)

F 90 (07/86-12/97)

**12-37 142 0004**  
81.30725.6084

**Clutch booster**



**Notes**

Force output F [N]	6000
Stroke [mm]	85

**References**

81.30725.6084	81.30725.6107
81.30725.6085	81.30725.6116
81.30725.6092	

**Application info**

LION'S COACH (09/95--)  
TGA (04/00--)

TGS (09/07--)  
TGX (09/07--)

**034 029 0034**  
81.30725.6104

**Clutch booster**



**Notes**

Force output F [N]	3900
Operating Pressure [bar]	8.4
Stroke [mm]	80
	Mineral Oil

**References**

81.30725.6104
---------------

**Application info**

HOCL (01/85-05/09)

**12-37 142 0001**

81.30715.6119

**Clutch master cylinder**
**Notes**

	Silver
	Grey Cast Iron
Bore Ø [mm]	23.81

**References**

81.30715.6111	81.30715.6121
81.30715.6119	

**Application info**

EM (08/87-06/97)	M 2000 M (--12/05)
F 2000 (01/94-12/95)	M 90 (08/88-06/96)
F 90 (07/86-12/97)	NG (--07/98)
F 90 Unterflur (07/86-05/94)	NM (--03/97)
LION'S COACH (09/95--)	SM (11/87-02/95)
LION'S STAR (01/93-09/96)	ÜL (09/89-09/96)

**Clutch master cylinder**
**12-37 142 0002**

81.30715.6120

**Notes**

	Silver
	Aluminium
Bore Ø [mm]	25.4

**References**

81.30715.6108	81.30715.6120
---------------	---------------

**Application info**

F 2000 (01/94-12/95)	F 90 Unterflur (07/86-05/94)
F 90 (07/86-12/97)	



**12-34 205 6013**  
81.44205.6013

**Repair kit, kingpin**



**Notes**

Outer Diameter [mm]	49.5
Outer Diameter [mm]	50
Length [mm]	223
	with ball bearing
	Front Axle

**References**

81.44205.6013

**Application info**

F 2000 (01/94-12/95)  
F 90 (07/86-12/97)  
F 90 Unterflur (07/86-05/94)  
M 2000 L (08/95--)  
M 2000 M (--12/05)  
M 90 (08/88-06/96)  
NG (--07/98)

NL (--07/98)  
NM (--03/97)  
SD (04/74-04/94)  
SG (07/76-06/97)  
SÜ (--06/97)  
ÜL (09/89-09/96)

**12-34 205 0001**  
81.44205.6023

**Repair kit, kingpin**



**Notes**

Outer Diameter [mm]	50
Outer Diameter [mm]	51
Length [mm]	222.5
	with ball bearing
	Front Axle

**References**

81.44205.6023

**Application info**

F 2000 (01/94-12/95)  
LION'S COACH (09/95--)  
M 2000 L (08/95--)  
M 2000 M (--12/05)

NG (--07/98)  
NL (--07/98)  
NÜ (09/96-07/98)



**12-34 798 0001**

81.44205.6025

**Repair kit, kingpin**
**Notes**

Outer Diameter [mm]	36
Outer Diameter [mm]	35
Length [mm]	172
	with ball bearing
	Front Axle Right
	Front Axle Left

**References**

81.44205.6025

**Application info**

L 2000 (10/93-07/97)

M 2000 L (08/95--)

**Bushing, leaf spring**
**12-34 610 0001**

81.43722.0044

**Notes**

Inner Diameter [mm]	24
Outer Diameter [mm]	70
Height [mm]	95
	Front Axle

**References**

81.43722.0044

81.43722.0061

83.43722.0001

**Application info**

E 2000 (05/00--)

F 2000 (01/94-12/95)

**Bushing, leaf spring**
**12-34 032 0003**

81.43722.0060

**Notes**

Inner Diameter [mm]	20
Outer Diameter [mm]	41
Outer Diameter 1 [mm]	58
Height [mm]	70
Length [mm]	84
	Rear
	Front

**References**

81.43722.0051

81.43722.0060

**Application info**

M 2000 L (08/95--)

M 2000 M (--12/05)



**12-34 032 0002**  
81.96020.0231

**Bushing, leaf spring**



**Notes**

Inner Diameter [mm]	16
Outer Diameter [mm]	50
Outer Diameter 1 [mm]	55
Height [mm]	95
	Left and right
	Rear Axle

**References**

81.96020.0231	81.96020.0252
81.96020.0250	

**Application info**

G (10/79-08/88)	L 2000 (10/93-07/97)
G 90 (09/87-05/95)	M 2000 M (--12/05)

**12-34 722 0062**  
81.43722.0062

**Mount, leaf spring**



**Notes**

Rear Axle

**References**

81.43722.0062

**Application info**

F 2000 (01/94-12/95)

**12-34 742 0000**  
81.96210.0554

**Mount, leaf spring**



**Notes**

Right  
Rear Axle

**References**

81.96210.0554

**Counterpart**

12-34 742 0001

**Application info**

TGA (04/00--)	TGS (09/07--)
TGM (10/05--)	TGX (09/07--)

**12-34 742 0001**  
81.96210.0555

**Mount, leaf spring**

**Notes**

Left  
Rear Axle

**References**

81.96210.0555

**Counterpart**

12-34 742 0000



**Application info**

TGA (04/00--)  
TGM (10/05--)

TGS (09/07--)  
TGX (09/07--)

**12-34 742 0006**  
81.96210.5022

**Mount, leaf spring**

**Notes**

Height [mm]                      127  
Rear Axle left and right

**References**

81.96210.5022



**Application info**

F 2000 (01/94-12/95)

F 90 (07/86-12/97)

**12-34 742 0005**  
81.96210.5025

**Mount, leaf spring**

**Notes**

Rear Axle left and right

**References**

81.96210.5025  
81.96210.5026

81.96210.5027



**Application info**

F 2000 (01/94-12/95)



**12-36 030 0013**  
81.43220.6247

**Control arm**



**Notes**

Hole Pitch 1/ Hole Pitch 2  
Bore Ø [mm]  
Pipe Ø [mm]  
Length [mm]

Steel  
130mm/130mm  
23  
50  
414  
Trailing Arm  
Rear Axle left and right

**References**

81.43220.6247

**Application info**

TGA (04/00--)  
TGS (09/07--)

TGX (09/07--)

**12-34 050 0003**  
81.43220.6260

**Control arm**



**Notes**

Hole Pitch 1/ Hole Pitch 2  
Bore Ø [mm]  
Pipe Ø [mm]  
Length [mm]

Steel  
115mm/115mm  
17  
48  
941  
Trailing Arm  
Front Axle

**References**

81.43220.6222  
81.43220.6260

81.43220.6283  
81.43220.6284

**Application info**

TGA (04/00--)  
TGS (09/07--)

TGX (09/07--)

**12-34 050 0002**  
81.43220.6268

**Control arm**



**Notes**

Hole Pitch 1/ Hole Pitch 2  
Bore Ø [mm]  
Pipe Ø [mm]  
Length [mm]

Steel  
130mm/130mm  
19  
52  
572  
Trailing Arm  
Trailing Axle

**References**

81.43220.6268

81.43220.6291



**12-34 050 0002**  
 81.43220.6268

**Control arm**
**Application info**

 TGA (04/00--)  
 TGS (09/07--)

TGX (09/07--)

**12-36 030 0016**  
 81.43220.6276

**Control arm**
**Notes**

Pipe Ø [mm]	48
Length [mm]	570
	Trailing Arm
	Rear Axle

**References**

36.43220.6002	81.43220.6183
36.43220.6043	81.43220.6276
81.43220.6139	81.43220.6277
81.43220.6151	

**Application info**

LION'S COACH (09/95--)

LION'S STAR (01/93-09/96)

**12-36 050 0001**  
 81.43270.6077

**Control arm**
**Notes**

	Steel
Hole Pitch 1/ Hole Pitch 2	152mm/152mm
Bore Ø [mm]	23
Pipe Ø [mm]	58
Length [mm]	627
	Wishbone (CV)
	Rear Axle

**References**

81.43270.6056	81.43270.6077
81.43270.6067	81.43270.6081
81.43270.6075	

**Application info**

F 2000 (01/94-12/95)

F 90 (07/86-12/97)



**12-36 050 0000**  
81.43270.6078

**Control arm**



**Notes**

Hole Pitch 1/ Hole Pitch 2	Steel
Bore Ø [mm]	152mm/152mm
Pipe Ø [mm]	23
Length [mm]	50
	621
	Wishbone (CV)
	Rear Axle

**References**

81.43270.6030	81.43270.6078
81.43270.6034	81.43270.6082
81.43270.6054	81.43270.9054
81.43270.6057	81.43270.9078
81.43270.6076	

**Parts list**

12-34 301 6132	Repair kit, control arm
----------------	-------------------------

**Application info**

F 2000 (01/94-12/95)	F 90 Unterflur (07/86-05/94)
F 90 (07/86-12/97)	

**12-36 035 6087**  
81.43270.6087

**Control arm**



**Notes**

Hole Pitch 1/ Hole Pitch 2	Steel
Bore Ø [mm]	130mm/130mm/152mm
Pipe Ø [mm]	25
Length [mm]	48
	627
	Wishbone (CV)
	Rear Axle

**References**

81.43270.6087	81.43270.6094
81.43270.6088	81.43270.6095

**Application info**

F 2000 (01/94-12/95)	TGS (09/07--)
TGA (04/00--)	TGX (09/07--)
TGM (10/05--)	

4

**12-34 035 0002**  
 81.43270.6096

**Control arm**
**Notes**

Hole Pitch 1/ Hole Pitch 2	Steel
Bore Ø [mm]	130mm/130mm
Pipe Ø [mm]	23
Length [mm]	48
	627
	Wishbone (CV)
	Rear Axle

**References**

81.43220.6221	81.43270.6114
81.43270.6096	

**Parts list**

12-34 301 6132	Repair kit, control arm
----------------	-------------------------

**Application info**

TGA (04/00--)	TGX (09/07--)
TGS (09/07--)	

**12-34 050 0001**  
 81.43270.6113

**Control arm**
**Notes**

Hole Pitch 1/ Hole Pitch 2	Steel
Bore Ø [mm]	130mm/152mm
Pipe Ø [mm]	25
Length [mm]	48
	627
	Wishbone (CV)
	Rear Axle

**References**

81.43270.6097	81.43270.6135
81.43270.6113	

**Application info**

TGA (04/00--)	TGX (09/07--)
TGS (09/07--)	

**12-34 035 0006**  
 81.43270.6117

**Control arm**
**Notes**

Hole Pitch 1/ Hole Pitch 2	Steel
Bore Ø [mm]	130mm/130mm
Pipe Ø [mm]	25
Length [mm]	58
	627
	Wishbone (CV)
	Rear Axle

**References**

81.43270.6117	
---------------	--





**12-34 035 0006**  
81.43270.6117

**Control arm**

**Application info**  
TGA (04/00--)

TGX (09/07--)

**12-34 035 0005**  
81.43270.6137

**Control arm**



**Notes**

Hole Pitch 1/ Hole Pitch 2  
Bore Ø [mm]  
Pipe Ø [mm]  
Length [mm]

Steel  
130mm/130mm/152mm  
25  
48  
627  
Wishbone (CV)  
Rear Axle

**References**

81.43270.6116

81.43270.6137

**Parts list**

12-34 230 6105

Repair kit, control arm

**Application info**  
F 2000 (01/94-12/95)  
TGA (04/00--)

TGS (09/07--)  
TGX (09/07--)

**12-36 035 0002**  
81.43220.6090

**Rod/strut, suspension**



**Notes**

Bore Ø 1 [mm]  
Bore Ø 2 [mm]  
Hole Pitch 1/ Hole Pitch 2  
Pipe Ø [mm]  
Length [mm]

19  
19  
Guide Rod  
130mm/130mm  
48  
590  
Trailing Arm  
Rear Axle

**References**

81.43220.6067  
81.43220.6068  
81.43220.6090

81.43220.6092  
81.43220.6120  
81.43220.9092

**Parts list**

12-34 220 6055

Repair kit, control arm

**Application info**  
F 2000 (01/94-12/95)  
F 90 (07/86-12/97)

TGA (04/00--)



**12-36 035 0003**  
 81.43220.6091

**Rod/strut, suspension**
**Notes**

Bore Ø 1 [mm]	21
Bore Ø 2 [mm]	21
	Guide Rod
Hole Pitch 1/ Hole Pitch 2	130mm/130mm
Pipe Ø [mm]	58
Length [mm]	585
	Trailing Arm
	Rear Axle

**References**

81.43220.6070	81.43220.6091
81.43220.6071	81.43220.6093
81.43220.6072	81.43220.6119

**Parts list**

12-34 001 0009	Repair kit, control arm
----------------	-------------------------

**Application info**

F 2000 (01/94-12/95)	TGA (04/00--)
F 90 (07/86-12/97)	

**12-36 030 0004**  
 81.43220.6129

**Rod/strut, suspension**
**Notes**

Bore Ø 1 [mm]	19
Bore Ø 2 [mm]	19
	Guide Rod
Hole Pitch 1/ Hole Pitch 2	130mm/130mm
Pipe Ø [mm]	48
Length [mm]	571
	Trailing Arm
	Rear Axle Lower

**References**

81.43220.6030	81.43220.6098
81.43220.6096	81.43220.6129
81.43220.6097	81.43230.6014

**Parts list**

12-34 220 6108	Repair kit, control arm
----------------	-------------------------

**Application info**

F 90 (07/86-12/97)	TGA (04/00--)
F 90 Unterflur (07/86-05/94)	TGS (09/07--)
M 90 (08/88-06/96)	TGX (09/07--)



**12-36 050 0002**  
81.43220.6190

**Rod/strut, suspension**



**Notes**

Bore Ø 1 [mm]	19
Bore Ø 2 [mm]	19
Guide Rod	130mm/130mm
Hole Pitch 1/ Hole Pitch 2	48
Pipe Ø [mm]	531
Length [mm]	Trailing Arm Rear Axle

**References**

81.43220.6161	81.43220.6190
---------------	---------------

**Parts list**

12-34 220 6055	Repair kit, control arm
----------------	-------------------------

**Application info**

TGA (04/00--)	TGX (09/07--)
TGS (09/07--)	

**12-36 035 6196**  
81.43220.6196

**Rod/strut, suspension**



**Notes**

Bore Ø 1 [mm]	19
Bore Ø 2 [mm]	19
Guide Rod	130mm/130mm
Hole Pitch 1/ Hole Pitch 2	48
Pipe Ø [mm]	596
Length [mm]	Trailing Arm Rear Axle

**References**

81.43220.6196	81.43220.6233
81.43220.6232	

**Parts list**

12-34 001 0004	Repair kit, control arm
----------------	-------------------------

**Application info**

F 2000 (01/94-12/95)	TGA (04/00--)
----------------------	---------------

4

**12-34 035 0003**  
 81.43220.6229

**Rod/strut, suspension**
**Notes**

Bore Ø 1 [mm]	19
Bore Ø 2 [mm]	19
	Guide Rod
Hole Pitch 1/ Hole Pitch 2	130mm/130mm
Pipe Ø [mm]	50
Length [mm]	572
	Trailing Arm
	Rear Axle

**References**

81.43220.6229	81.43220.6304
81.43220.6236	81.43220.6305
81.43220.6267	81.43220.9236
81.43220.6272	

**Parts list**

12-34 220 6108	Repair kit, control arm
----------------	-------------------------

**Application info**

TGA (04/00--)	TGX (09/07--)
TGS (09/07--)	

**Repair kit, control arm**
**12-34 220 6055**  
 81.43220.6107

**Notes**

Hole Pitch 1/ Hole Pitch 2	130,0
Bore Ø [mm]	19
Thickness [mm]	30
Outer Diameter [mm]	85
	for wishbone (CV)
	Rear Axle

**References**

81.43220.6006	81.43220.6073
81.43220.6055	81.43220.6107

**Application info**

EL (01/93-06/97)	NL (--07/98)
EM (08/87-06/97)	NM (--03/97)
LION'S COACH (09/95--)	NÜ (09/96-07/98)
LION'S STAR (01/93-09/96)	TGA (04/00--)
NG (--07/98)	ÜL (09/89-09/96)



**12-34 220 6108**

81.43220.6108

**Repair kit, control arm**



**Notes**

Thickness [mm]	30
Inner Diameter [mm]	19
Outer Diameter [mm]	72
Outer Diameter [mm]	65
Length [mm]	129.5
	for wishbone (CV)
	Left and right

**References**

81.43220.6108	81.43220.6132
---------------	---------------

**Application info**

F 2000 (01/94-12/95)

TGA (04/00--)

**16-34 653 0001**

81.43220.6197

**Repair kit, control arm**

**Notes**

Bore Ø [mm]	15
Outer Diameter [mm]	67
Length [mm]	129
	for drag link
	Front Axle

**References**

81.43220.6197	81.95302.0057
81.95302.0038	

**Application info**

M 2000 L (08/95--)

M 2000 M (--12/05)

**14-36 035 0003**

81.43220.6203

**Repair kit, control arm**



**Notes**

Hole Pitch 1/ Hole Pitch 2	130
Thickness [mm]	30
	for drag link
	Rear Axle

**References**

81.43220.6203

**Application info**

LION'S COACH (09/95--)  
LION'S STAR (01/93-09/96)

ÜL (09/89-09/96)

**12-34 001 0009**

81.43220.6241

**Repair kit, control arm**
**Notes**

Hole Pitch 1/ Hole Pitch 2	130
Bore Ø [mm]	21
	for drag link
	Front Axle

**References**

81.43220.6241

**Application info**

E 2000 (05/00--)	TGA (04/00--)
F 2000 (01/94-12/95)	TGS (09/07--)
F 90 (07/86-12/97)	TGX (09/07--)

**Repair kit, control arm**
**12-34 250 6244**

81.43220.6244

**Notes**

Hole Pitch 1/ Hole Pitch 2	115
Bore Ø [mm]	17
Thickness [mm]	24
Outer Diameter [mm]	75
Length [mm]	149
	for drag link
	Front Axle

**References**

81.43220.6244

**Application info**

TGA (04/00--)

**Repair kit, control arm**
**12-34 230 6051**

81.43230.6051

**Notes**

Hole Pitch 1/ Hole Pitch 2	115
Bore Ø [mm]	17
Thickness [mm]	24
Outer Diameter [mm]	75
Length [mm]	150
	for drag link
	Rear Axle

**References**

81.43230.6051	81.43230.6068
---------------	---------------





**12-34 230 6051**  
81.43230.6051

**Repair kit, control arm**

+ <b>Application info</b>	F 2000 (01/94-12/95)	M 2000 L (08/95--)
	F 90 (07/86-12/97)	M 2000 M (--12/05)
	F 90 Unterflur (07/86-05/94)	M 90 (08/88-06/96)

**034 035 0029**  
81.43270.6040

**Repair kit, control arm**



<b>Notes</b>	
Hole Pitch 1/ Hole Pitch 2	152
Bore Ø [mm]	21
Thickness [mm]	24
Outer Diameter [mm]	95
Length [mm]	190
	for wishbone (CV) Front and Rear Rear Axle

<b>References</b>	
81.43270.6040	81.43270.6045

**Application info**

R (05/85-01/93)	SL II (--04/94)
SG (07/76-06/97)	SÜ (--06/97)
SL (05/80-04/87)	

**12-34 001 0001**  
81.43270.6065

**Repair kit, control arm**



<b>Notes</b>	
	for wishbone (CV) Rear Axle

<b>References</b>	
81.43270.6065	

**Application info**

F 90 Unterflur (07/86-05/94)	M 2000 M (--12/05)
M 2000 L (08/95--)	M 90 (08/88-06/96)

**12-34 270 6079**  
 81.43270.6079

**Repair kit, control arm**
**Notes**

Hole Pitch 1/ Hole Pitch 2	152
Bore Ø [mm]	23
Thickness [mm]	24
Outer Diameter [mm]	95
Length [mm]	193
	for wishbone (CV)
	Rear Axle
	Front Axle

**References**

81.43270.6079	81.43270.6099
---------------	---------------

**Application info**

F 90 (07/86-12/97)

**12-34 301 6132**  
 81.43270.6080

**Repair kit, control arm**
**Notes**

Thickness [mm]	61
Outer Diameter [mm]	80
Outer Diameter [mm]	90
	for wishbone (CV)
	Left and right

**References**

81.43270.6080	81.95301.6132
---------------	---------------

**Application info**

 F 2000 (01/94-12/95)  
 F 90 (07/86-12/97)  
 F 90 Unterflur (07/86-05/94)

 M 2000 M (--12/05)  
 M 90 (08/88-06/96)  
 TGA (04/00--)

**12-34 301 6133**  
 81.95301.6133

**Repair kit, control arm**
**Notes**

Thickness [mm]	35
Inner Diameter [mm]	23
Outer Diameter [mm]	80
Outer Diameter [mm]	90
Length [mm]	152
	for wishbone (CV)
	Left and right

**References**

81.43270.6083	81.95301.6133
---------------	---------------





**12-34 301 6133**  
81.95301.6133

**Repair kit, control arm**

**Application info**  
F 2000 (01/94-12/95)  
F 90 (07/86-12/97)  
F 90 Unterflur (07/86-05/94)

M 2000 M (--12/05)  
M 90 (08/88-06/96)

**12-34 271 0029**  
81.43271.0029

**Bushing, stabilizer**



**Notes**

Inner Diameter [mm]	16
Outer Diameter [mm]	45
Outer Diameter [mm]	42
Height [mm]	35
	Rear Axle

**References**

81.43271.0008	81.43271.0029
---------------	---------------

**Application info**

M 2000 L (08/95--)

M 90 (08/88-06/96)

**12-34 271 0081**  
81.43271.0081

**Bushing, stabilizer**



**Notes**

Inner Diameter [mm]	52
Outer Diameter [mm]	94
Outer Diameter [mm]	70
Height [mm]	80
	Rear Axle

**References**

81.43271.0081

**Application info**

F 2000 (01/94-12/95)  
F 90 (07/86-12/97)

F 90 Unterflur (07/86-05/94)  
M 90 (08/88-06/96)

4



**12-34 704 0057**  
 81.43704.0057

**Bushing, stabilizer**
**Notes**

Inner Diameter [mm]	45
Outer Diameter [mm]	69
Height [mm]	60
	Front Axle

**References**

81.43704.0057

**Application info**

 F 2000 (01/94-12/95)  
 F 90 (07/86-12/97)

 F 90 Unterflur (07/86-05/94)  
 M 90 (08/88-06/96)

**12-34 704 0060**  
 81.43704.0060

**Bushing, stabilizer**
**Notes**

Inner Diameter [mm]	54
Outer Diameter [mm]	78
Height [mm]	60
	Rear Axle

**References**

81.43704.0060

**Application info**

 F 2000 (01/94-12/95)  
 F 90 (07/86-12/97)  
 F 90 Unterflur (07/86-05/94)

 M 2000 L (08/95--)  
 M 2000 M (--12/05)  
 M 90 (08/88-06/96)

**12-34 704 0061**  
 81.43704.0061

**Bushing, stabilizer**
**Notes**

Inner Diameter [mm]	59
Outer Diameter [mm]	78
Height [mm]	60
	Rear Axle

**References**

81.43704.0061





**12-34 704 0061**  
81.43704.0061

**Bushing, stabilizer**

**Application info**

F 2000 (01/94-12/95)  
F 90 (07/86-12/97)

F 90 Unterflur (07/86-05/94)  
M 90 (08/88-06/96)

**12-34 271 0095**  
81.43704.0077

**Bushing, stabilizer**



**Notes**

Inner Diameter [mm]	50
Outer Diameter [mm]	75
Height [mm]	51
	Front Axle

**References**

81.43704.0077

**Application info**

L 2000 (10/93-07/97)  
LION'S COACH (09/95--)  
NG (-07/98)  
NL (-07/98)

NÜ (09/96-07/98)  
TGA (04/00--)  
TGL (04/05--)  
TGM (10/05--)

**12-34 722 0019**  
81.43722.0019

**Bushing, stabilizer**



**Notes**

Inner Diameter [mm]	22
Outer Diameter [mm]	75
Height [mm]	62
	Rear Axle

**References**

81.43722.0019                      81.43722.6051

**Application info**

F 2000 (01/94-12/95)  
F 90 (07/86-12/97)

F 90 Unterflur (07/86-05/94)  
TGA (04/00--)

**12-34 271 0040**  
 81.43722.0040

**Bushing, stabilizer**
**Notes**

Inner Diameter [mm]	56
Outer Diameter [mm]	84
Height [mm]	70
	Rear Axle

**References**

81.43722.0040	81.43722.0042
81.43722.0041	

**Application info**

CLA (01/06--)	M 90 (08/88-06/96)
EM (08/87-06/97)	NM (--03/97)
F 2000 (01/94-12/95)	TGA (04/00--)
F 90 (07/86-12/97)	TGL (04/05--)
M 2000 L (08/95--)	TGM (10/05--)
M 2000 M (--12/05)	

**Bushing, stabilizer**
**12-34 271 0101**  
 81.43722.0052

**Notes**

Inner Diameter [mm]	34.5
Outer Diameter [mm]	55
Height [mm]	60
	Left and right
	Front Axle

**References**

81.43722.0052

**Application info**

L 2000 (10/93-07/97)	M 2000 M (--12/05)
M 2000 L (08/95--)	

**Bushing, stabilizer**
**12-34 271 0094**  
 81.43722.0053

**Notes**

Inner Diameter [mm]	38
Outer Diameter [mm]	55
Height [mm]	60
	Rear Axle

**References**

81.43722.0053	85.93020.0005
---------------	---------------





**12-34 271 0094**  
81.43722.0053

**Bushing, stabilizer**

<p><b>Application info</b> L 2000 (10/93-07/97) M 2000 L (08/95--)</p>	<p>M 2000 M (--12/05)</p>
--	---------------------------

**12-34 271 0088**  
81.43722.0083

**Bushing, stabilizer**



**Notes**

Inner Diameter [mm]	60
Outer Diameter [mm]	89
Height [mm]	62
	Rear Axle

**References**  
81.43722.0083

**Application info**  
TGA (04/00--)  
TGM (10/05--)

TGS (09/07--)  
TGX (09/07--)

**12-34 271 0100**  
81.96210.0294

**Bushing, stabilizer**



**Notes**

Inner Diameter [mm]	12
Outer Diameter [mm]	31.5
Height [mm]	32
	Front Axle

**References**  
81.96210.0294

**Application info**  
G 90 (09/87-05/95)

M 90 (08/88-06/96)

4

**12-34 271 0089**  
 85.43704.0002

**Bushing, stabilizer**
**Notes**

Inner Diameter [mm]	31
Outer Diameter [mm]	53
Height [mm]	46
	Rear Axle

**References**

85.43704.0002

**Application info**

TGL (04/05--)

**12-34 271 0090**  
 85.43704.0004

**Bushing, stabilizer**
**Notes**

Inner Diameter [mm]	38.25
Outer Diameter [mm]	51.95
Height [mm]	46.2
	Left and right

**References**

85.43704.0004

**Application info**

TGL (04/05--)

**12-34 271 0092**  
 85.43704.0005

**Bushing, stabilizer**
**Notes**

Inner Diameter [mm]	26
Outer Diameter [mm]	46
Height [mm]	66
	Left and right

**References**

85.43704.0005

**Application info**

TGL (04/05--)



**12-34 271 0091**  
85.43722.0007

**Bushing, stabilizer**



**Notes**

Inner Diameter [mm]	14
Outer Diameter [mm]	42.5
Height [mm]	35
	Left and right
	Rear Axle
	Front Axle

**References**

85.43722.0007

**Application info**

TGL (04/05--)

**12-34 271 0080**  
81.43271.0080

**Mount, stabilizer**



**Notes**

Inner Diameter [mm]	15
Outer Diameter [mm]	65
	Rear Axle

**References**

81.43271.0080

**Application info**

F 2000 (01/94-12/95)  
F 90 (07/86-12/97)

F 90 Unterflur (07/86-05/94)  
M 90 (08/88-06/96)

**12-34 271 0082**  
81.43271.0082

**Mount, stabilizer**



**Notes**

Inner Diameter [mm]	21
Outer Diameter [mm]	65
	Rear Axle

**References**

81.43271.0082

**Application info**

F 2000 (01/94-12/95)  
F 90 (07/86-12/97)

F 90 Unterflur (07/86-05/94)  
M 2000 L (08/95--)

4

**12-34 704 0029**

81.43704.0029

**Mount, stabilizer**
**Notes**

Inner Diameter [mm]	45
Outer Diameter 2 [mm]	70
Outer Diameter 1 [mm]	58
Height [mm]	80
	Front Axle

**References**

81.43704.0029

**Application info**

 G 90 (09/87-05/95)  
 L 2000 (10/93-07/97)

 M 2000 L (08/95--)  
 M 90 (08/88-06/96)

**12-34 271 0096**

81.43704.0074

**Mount, stabilizer**
**Notes**

Inner Diameter [mm]	44
Outer Diameter [mm]	64
Height [mm]	65
	Front Axle left and right

**References**

81.43704.0074

**Application info**

CLA (01/06--)

**12-34 271 0084**

81.43704.0078

**Mount, stabilizer**
**Notes**

Inner Diameter [mm]	45
Outer Diameter [mm]	75
Height [mm]	51
	Front Axle

**References**

81.43704.0078



4

+



**12-34 271 0084**  
81.43704.0078

**Mount, stabilizer**

<b>+</b> Application info	LION'S COACH (09/95--)	TGS (09/07--)
	LION'S STAR (01/93-09/96)	TGX (09/07--)
	TGA (04/00--)	ÜL (09/89-09/96)
	TGM (10/05--)	

**12-34 271 0086**  
81.43722.0038

**Mount, stabilizer**



<b>Notes</b>	
Inner Diameter [mm]	16
Outer Diameter [mm]	47.5
Height [mm]	47
	Front Axle
<b>References</b>	
81.43722.0022	81.96210.0450
81.43722.0038	81.96210.0469

<b>Application info</b>	F 2000 (01/94-12/95)	M 90 (08/88-06/96)
	F 90 (07/86-12/97)	TGA (04/00--)
	F 90 Unterflur (07/86-05/94)	TGL (04/05--)
	G 90 (09/87-05/95)	TGM (10/05--)
	L 2000 (10/93-07/97)	TGS (09/07--)
	M 2000 L (08/95--)	TGX (09/07--)
	M 2000 M (--12/05)	

**12-34 271 0085**  
81.43722.0059

**Mount, stabilizer**



<b>Notes</b>	
Inner Diameter [mm]	16
Outer Diameter [mm]	50
Height [mm]	47
	Front Axle
<b>References</b>	
81.43722.0059	

<b>Application info</b>	CLA (01/06--)	M 90 (08/88-06/96)
	F 2000 (01/94-12/95)	NL (--07/98)
	F 90 (07/86-12/97)	TGA (04/00--)
	F 90 Unterflur (07/86-05/94)	TGL (04/05--)
	L 2000 (10/93-07/97)	TGM (10/05--)
	LION'S STAR (01/93-09/96)	TGS (09/07--)
	M 2000 L (08/95--)	TGX (09/07--)
	M 2000 M (--12/05)	ÜL (09/89-09/96)



**12-34 722 0021**  
 81.43722.0063

**Mount, stabilizer**
**Notes**

Inner Diameter [mm]	22
Outer Diameter [mm]	68
Height [mm]	62
	Rear Axle left and right

**References**

81.43722.0021	81.43722.0081
81.43722.0039	81.43722.0082
81.43722.0063	

**Application info**

CLA (01/06--)	M 2000 M (--12/05)
EM (08/87-06/97)	M 90 (08/88-06/96)
F 2000 (01/94-12/95)	NM (--03/97)
F 90 (07/86-12/97)	TGA (04/00--)
F 90 Unterflur (07/86-05/94)	TGM (10/05--)
L 2000 (10/93-07/97)	TGS (09/07--)
M 2000 L (08/95--)	TGX (09/07--)

**Mount, stabilizer**
**12-34 271 0098**  
 81.43722.0068

**Notes**

Inner Diameter [mm]	49
Outer Diameter [mm]	83
Height [mm]	72
	Rear Axle

**References**

81.43722.0068

**Application info**

TGA (04/00--)

**Mount, stabilizer**
**12-34 271 0083**  
 81.43722.0072

**Notes**

Inner Diameter [mm]	15
Outer Diameter [mm]	68.5
	Rear Axle

**References**

81.43722.0072





**12-34 271 0083**  
81.43722.0072

**Mount, stabilizer**

**Application info**  
TGA (04/00--)

TGS (09/07--)

**12-14 650 0005**  
06.32489.0003

**Wheel bearing**



**Notes**

Inner Diameter [mm]	45
Outer Diameter [mm]	85
Height [mm]	32.2
	Tapered Roller Bearing
	Outer
	Front Axle

**References**

06.32489.0003	81.93420.0078
06.32489.0044	

**Application info**

M 2000 L (08/95--)  
M 2000 M (--12/05)

M 90 (08/88-06/96)

**034 650 0001**  
06.32499.0016

**Wheel bearing**



**Notes**

Inner Diameter [mm]	50
Outer Diameter [mm]	110
Height [mm]	42.25
DIN / ISO	32310 A
	Tapered Roller Bearing
	Outer
	Rear Axle left and right
	Front Axle left and right

**References**

06.32490.3200	81.93420.0131
06.32499.0016	87.52340.0820
06.32499.0034	

**Application info**

EL (01/93-06/97)  
F 2000 (01/94-12/95)  
F 90 (07/86-12/97)  
F 90 Unterflur (07/86-05/94)  
LION'S COACH (09/95--)  
LION'S STAR (01/93-09/96)  
M 2000 M (--12/05)

M 90 (08/88-06/96)  
NG (--07/98)  
NL (--07/98)  
NM (--03/97)  
SL II (--04/94)  
ÜL (09/89-09/96)

**034 650 0000**  
 06.32499.0020

**Wheel bearing**
**Notes**

Inner Diameter [mm]	70
Outer Diameter [mm]	150
Height [mm]	54
DIN / ISO	32314
	Tapered Roller Bearing inner
	Left and right
	Front Axle

**References**

06.32499.0020	06.32499.0085
06.32499.0082	06.32499.0157
06.32499.0084	87.52340.1240

**Application info**

F 2000 (01/94-12/95)	TGS (09/07--)
F 90 (07/86-12/97)	TGX (09/07--)
F 90 Unterflur (07/86-05/94)	

**Wheel bearing**
**12-14 650 0002**  
 06.32499.0079

**Notes**

Inner Diameter [mm]	35
Outer Diameter [mm]	72
Height [mm]	24.25
DIN / ISO	32207
	Tapered Roller Bearing Outer
	Front Axle left and right

**References**

06.32499.0068	87.52330.0200
06.32499.0079	

**Application info**

G (10/79-08/88)	L 2000 (10/93-07/97)
G 90 (09/87-05/95)	M 2000 L (08/95--)

**Wheel bearing**
**300 334 1103**  
 51.93410.0079

**Notes**

Alternative Repair Kit	300 334 1103/S
Inner Diameter [mm]	37
Outer Diameter [mm]	74
Height [mm]	45
	Rear Axle

**References**

51.93410.0079





**300 334 1103**  
51.93410.0079

**Wheel bearing**

**Application info**

F 2000 (01/94-12/95)  
F 90 (07/86-12/97)

F 90 Unterflur (07/86-05/94)  
M 90 (08/88-06/96)

**12-14 751 0006**  
81.93420.0320

**Wheel bearing**



**Notes**

Inner Diameter [mm]	105
Outer Diameter [mm]	160
Height [mm]	140

**References**

81.93420.0320	81.93420.0376
81.93420.0342	81.93420.6097

**Application info**

L 2000 (10/93-07/97)  
LION'S COACH (09/95--)  
LION'S STAR (01/93-09/96)  
M 2000 L (08/95--)  
M 2000 M (--12/05)  
NG (--07/98)

NL (--07/98)  
NÜ (09/96-07/98)  
TGA (04/00--)  
TGM (10/05--)  
TGS (09/07--)  
TGX (09/07--)

**12-14 650 0006**  
81.93420.0330

**Wheel bearing**



**Notes**

Inner Diameter [mm]	57.8
Outer Diameter [mm]	110
Height [mm]	115
	Tapered Roller Bearing
	Front Axle
	Rear Axle

**References**

81.93420.0288	81.93420.0349
81.93420.0330	

**Application info**

F 2000 (01/94-12/95)  
LION'S COACH (09/95--)  
LION'S STAR (01/93-09/96)

TGA (04/00--)  
TGM (10/05--)

**Wheel bearing**
**034 650 0020**  
 81.93420.0336

**Notes**

Inner Diameter [mm]	78
Outer Diameter [mm]	130
Height [mm]	90

**References**

81.93420.0336	81.93420.6083
81.93420.0379	81.93420.6099

**Application info**

L 2000 (10/93-07/97)	TGL (04/05--)
----------------------	---------------

**Wheel bearing**
**12-34 751 0001**  
 81.93420.0336

**Notes**

Inner Diameter [mm]	78
Outer Diameter [mm]	130
Height [mm]	90
	Rear Axle

**References**

81.93420.0336

**Application info**

L 2000 (10/93-07/97)	TGM (10/05--)
TGL (04/05--)	

**Wheel bearing**
**12-14 751 0007**  
 81.93420.0346

**Notes**

Inner Diameter [mm]	110
Outer Diameter [mm]	170
Height [mm]	145.8
	Rear Axle

**References**

81.93420.0346



+



**12-14 751 0007**  
81.93420.0346

**Wheel bearing**

**Application info**

F 2000 (01/94-12/95)  
TGA (04/00--)  
TGM (10/05--)

TGS (09/07--)  
TGX (09/07--)

**034 035 0005**  
81.90801.0224

**Gasket set, planetary gear box**

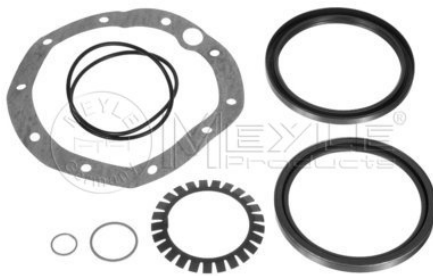

**Notes**

with lock ring

**References**

81.90801.0224

**Parts list**

034 035 0005/S

Gasket set, planetary gear box

**Application info**

EM (08/87-06/97)  
F 2000 (01/94-12/95)  
F 90 (07/86-12/97)  
F 90 Unterflur (07/86-05/94)  
G 90 (09/87-05/95)  
L 2000 (10/93-07/97)  
LION'S COACH (09/95--)  
LION'S STAR (01/93-09/96)  
M 2000 L (08/95--)  
M 2000 M (--12/05)  
M 90 (08/88-06/96)  
NG (--07/98)

NL (--07/98)  
NM (--03/97)  
NÜ (09/96-07/98)  
R (05/85-01/93)  
SD (04/74-04/94)  
SG (07/76-06/97)  
SL (05/80-04/87)  
SL II (--04/94)  
SR (10/75-11/86)  
SÜ (--06/97)  
TGA (04/00--)  
ÜL (09/89-09/96)

**034 035 0013**  
81.96601.0298

**Gasket set, planetary gear box**



**Notes**

with seal  
with lock ring

**References**

81.96601.0298

4

+

## Gasket set, planetary gear box

**034 035 0013**  
 81.96601.0298

### Application info

EL (01/93-06/97)  
 EM (08/87-06/97)  
 F 2000 (01/94-12/95)  
 F 90 (07/86-12/97)  
 F 90 Unterflur (07/86-05/94)  
 G 90 (09/87-05/95)  
 L 2000 (10/93-07/97)  
 LION'S COACH (09/95--)  
 LION'S COMFORT (09/96--)  
 LION'S STAR (01/93-09/96)

M 2000 L (08/95--)  
 M 2000 M (--12/05)  
 M 90 (08/88-06/96)  
 NG (--07/98)  
 NL (--07/98)  
 NM (--03/97)  
 NÜ (09/96-07/98)  
 TGA (04/00--)  
 ÜL (09/89-09/96)

## Ring, wheel hub

**034 035 0003**  
 81.35710.0044

### Notes

Inner Diameter [mm]	115
Outer Diameter [mm]	145
Height [mm]	32
Axle Load [t]	13

### References

81.35710.0044



### Application info

F 2000 (01/94-12/95)  
 F 90 (07/86-12/97)

F 90 Unterflur (07/86-05/94)  
 M 90 (08/88-06/96)

## Ring, wheel hub

**034 035 0001**  
 81.35710.0045

### Notes

Inner Diameter [mm]	110
Outer Diameter [mm]	145
Height [mm]	32
Axle Load [t]	10

### References

81.35710.0045



### Application info

F 2000 (01/94-12/95)  
 F 90 (07/86-12/97)  
 F 90 Unterflur (07/86-05/94)  
 M 2000 L (08/95--)

M 90 (08/88-06/96)  
 SG (07/76-06/97)  
 SL (05/80-04/87)  
 SR (10/75-11/86)



**12-14 753 0000**  
06.56289.0307

**Shaft seal, wheel hub**



**Notes**

Inner Diameter [mm]	145
Outer Diameter [mm]	174
Height [mm]	16
	Rear Axle

**References**

06.56289.0257	06.56289.0308
06.56289.0261	06.56289.0309
06.56289.0272	06.56289.0386
06.56289.0307	

**Application info**

F 2000 (01/94-12/95)	M 2000 M (--12/05)
F 90 (07/86-12/97)	M 90 (08/88-06/96)
LION'S STAR (01/93-09/96)	

**12-34 753 0000**  
06.56289.0330

**Shaft seal, wheel hub**



**Notes**

Inner Diameter [mm]	145
Outer Diameter [mm]	175
Height [mm]	13
	Rear Axle

**References**

06.56279.0033	06.56289.0333
06.56289.0065	06.56289.0334
06.56289.0330	81.96503.0154
06.56289.0331	

**Application info**

F 2000 (01/94-12/95)	M 2000 L (08/95--)
F 90 (07/86-12/97)	M 2000 M (--12/05)
F 90 Unterflur (07/86-05/94)	M 90 (08/88-06/96)
G 90 (09/87-05/95)	TGA (04/00--)
L 2000 (10/93-07/97)	

**12-14 753 0002**  
06.56289.0357

**Shaft seal, wheel hub**



**Notes**

Inner Diameter [mm]	85
Outer Diameter [mm]	105
Height [mm]	13
	Rear Axle

**References**

06.56289.0047	06.56289.0357
06.56289.0048	





**12-14 753 0002**  
 06.56289.0357

**Shaft seal, wheel hub**
**Application info**

 F 2000 (01/94-12/95)  
 F 90 (07/86-12/97)

 F 90 Unterflur (07/86-05/94)  
 TGA (04/00--)

**034 753 0020**  
 06.56289.0371

**Shaft seal, wheel hub**
**Notes**

Inner Diameter [mm]	145
Outer Diameter [mm]	205
Outer Diameter [mm]	175
Height [mm]	9
	Outer
	Rear Axle
	Front Axle

**References**

06.56289.0371

**Application info**

 EL (01/93-06/97)  
 F 2000 (01/94-12/95)  
 F 90 (07/86-12/97)  
 F 90 Unterflur (07/86-05/94)  
 M 2000 L (08/95--)  
 M 2000 M (--12/05)

 M 90 (08/88-06/96)  
 NG (--07/98)  
 NL (--07/98)  
 TGA (04/00--)  
 TGS (09/07--)  
 TGX (09/07--)  
 4

**12-14 753 0007**  
 06.56289.0387

**Shaft seal, wheel hub**
**Notes**

Inner Diameter [mm]	132
Outer Diameter [mm]	160
Height [mm]	10
	Rear Axle

**References**

06.56289.0387

**Application info**

 M 2000 L (08/95--)  
 M 2000 M (--12/05)  
 TGA (04/00--)

 TGM (10/05--)  
 TGS (09/07--)  
 TGX (09/07--)  
 181



**12-14 653 0001**  
81.52403.6001

**Shaft seal, wheel hub**



**Notes**

Inner Diameter [mm]	81
Outer Diameter [mm]	137
Outer Diameter [mm]	100
Height [mm]	15.5
	Front Axle

**References**

81.52403.6001

**Application info**

L 2000 (10/93-07/97)

M 2000 L (08/95--)

**12-14 753 0004**  
81.96501.0861

**Shaft seal, wheel hub**



**Notes**

Inner Diameter [mm]	145
Outer Diameter [mm]	175
Height [mm]	14
	Rear Axle
	Front Axle

**References**

06.56289.0027	06.56289.0335
06.56289.0064	81.96501.0861
06.56289.0332	81.96506.0155

**Application info**

F 2000 (01/94-12/95)  
F 90 (07/86-12/97)  
M 2000 L (08/95--)

M 2000 M (--12/05)  
M 90 (08/88-06/96)  
TGA (04/00--)

**12-14 653 0000**  
81.96502.6081

**Shaft seal, wheel hub**



**Notes**

Inner Diameter [mm]	100
Outer Diameter [mm]	130
Height [mm]	12
	Front Axle

**References**

81.96502.6081



**Shaft seal, wheel hub**
**12-14 653 0000**  
 81.96502.6081

**Application info**

F 2000 (01/94-12/95)	M 2000 M (--12/05)
F 90 (07/86-12/97)	NG (--07/98)
F 90 Unterflur (07/86-05/94)	NL (--07/98)
LION'S COACH (09/95--)	SG (07/76-06/97)
LION'S STAR (01/93-09/96)	SL II (--04/94)
M 2000 L (08/95--)	ÜL (09/89-09/96)

**Shaft seal, wheel hub**
**034 753 0017**  
 81.96503.0155

**Notes**

Inner Diameter [mm]	145
Outer Diameter [mm]	175
Height [mm]	14
	Rear Axle

**References**

81.96503.0155

**Application info**

F 2000 (01/94-12/95)	M 2000 M (--12/05)
F 90 (07/86-12/97)	M 90 (08/88-06/96)
M 2000 L (08/95--)	TGA (04/00--)

**Shaft seal, wheel hub**
**12-14 753 0005**  
 81.96503.0161

**Notes**

Inner Diameter [mm]	87.3
Outer Diameter [mm]	120.7
Height [mm]	13
	inner
	Rear Axle

**References**

81.96503.0161

**Application info**

G 90 (09/87-05/95)	L 2000 (10/93-07/97)
--------------------	----------------------



**12-14 753 0008**  
81.96503.0333

**Shaft seal, wheel hub**



**Notes**

Inner Diameter [mm]	132
Outer Diameter [mm]	172
Height [mm]	12
	inner
	Rear Axle

**References**

81.96503.0333	81.96503.0399
---------------	---------------

**Application info**

L 2000 (10/93-07/97)  
M 2000 L (08/95--)  
M 2000 M (--12/05)  
TGA (04/00--)

TGM (10/05--)  
TGS (09/07--)  
TGX (09/07--)

**12-14 753 0006**  
81.96503.0398

**Shaft seal, wheel hub**



**Notes**

Inner Diameter [mm]	135
Outer Diameter [mm]	175
Outer Diameter [mm]	205
Height [mm]	11
	Rear Axle

**References**

81.96503.0188	81.96503.0398
---------------	---------------

**Application info**

F 2000 (01/94-12/95)  
F 90 (07/86-12/97)  
F 90 Unterflur (07/86-05/94)  
L 2000 (10/93-07/97)

M 2000 L (08/95--)  
M 2000 M (--12/05)  
M 90 (08/88-06/96)

**12-14 753 0009**  
81.96503.0530

**Shaft seal, wheel hub**



**Notes**

Inner Diameter [mm]	139
Outer Diameter [mm]	170
Height [mm]	11
	Outer
	Rear Axle

**References**

81.96503.0339	81.96503.0530
81.96503.0445	



**12-14 753 0009**  
 81.96503.0530

**Shaft seal, wheel hub**
**Application info**

F 2000 (01/94-12/95)

TGA (04/00--)

**12-14 753 0010**  
 81.96503.6000

**Shaft seal, wheel hub**
**Notes**

Inner Diameter [mm]	139
Outer Diameter [mm]	175
Outer Diameter [mm]	205
Height [mm]	16.3
	Rear Axle

**References**

81.96503.6000

**Application info**

F 2000 (01/94-12/95)

TGA (04/00--)

TGM (10/05--)

**Wheel nut**
**034 040 0002**  
 81.45503.0056

**Notes**

Inner Thread [mm]	M22x1,5
Spanner Size	32
Quality/ Grade	10

**References**

81.45503.0049

81.45503.0056

**Application info**

F 2000 (01/94-12/95)

F 90 (07/86-12/97)

G 90 (09/87-05/95)

L 2000 (10/93-07/97)



**12-34 632 0001**  
81.05504.6001

**Hydraulic filter, steering system**



**References**

81.05504.6001	82.05504.6001
81.47307.0001	

**Application info**

F 2000 (01/94-12/95)	TGA (04/00--)
F 90 (07/86-12/97)	

**034 046 0000**  
81.47301.6005

**Hydraulic filter, steering system**



**Notes**

Thickness [mm]	100
Inner Diameter [mm]	17.1
Outer Diameter [mm]	59

**References**

81.47301.6005

**Application info**

CLA (01/06--)	NG (--07/98)
EL (01/93-06/97)	NL (--07/98)
F 2000 (01/94-12/95)	NÜ (09/96-07/98)
F 90 (07/86-12/97)	SÜ (--06/97)
L 2000 (10/93-07/97)	TGA (04/00--)
LION'S COACH (09/95--)	TGL (04/05--)
LION'S COMFORT (09/96--)	TGM (10/05--)
LION'S STAR (01/93-09/96)	TGS (09/07--)
M 2000 L (08/95--)	TGX (09/07--)
M 2000 M (--12/05)	ÜL (09/89-09/96)

5

**Tie rod assembly**

**12-36 030 0011/HD**

81.46711.6721

**Notes**

	Guide Rod
Pipe Ø [mm]	Nut with lateral notches 50 with metric thread
Thread Measurement 2	M30x1,5
Thread Measurement 1	M24x1,5
Length [mm]	1406
Cone Size [mm]	30
Reinforced Version	Front Axle

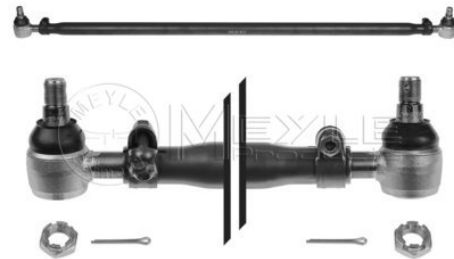
**References**

81.46610.6689	81.46711.6721
81.46610.6720	

**Parts list**

036 020 0004/HD	Tie rod end
036 020 0005/HD	Tie rod end

**Application info**

F 2000 (01/94-12/95)

**Tie rod assembly**
**12-36 030 0002**

81.46711.6725

**Notes**

	Guide Rod
Pipe Ø [mm]	Nut with lateral notches 50 with metric thread
Thread Measurement 2	M30x1,5
Thread Measurement 1	M24x1,5
Length [mm]	1652
Cone Size [mm]	30
	Front Axle

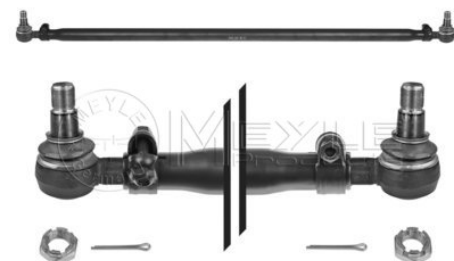
**References**

81.46710.6112	81.46710.6354
81.46710.6163	81.46710.6361
81.46710.6165	81.46711.6725
81.46710.6198	81.46711.6820
81.46710.6353	81.46711.6849

**Parts list**

036 020 0004	Tie rod end
036 020 0005	Tie rod end

**Application info**

 F 90 (07/86-12/97)  
 TGA (04/00-)

 TGS (09/07--)  
 TGX (09/07--)



**12-36 030 0002/HD**  
81.46711.6725

**Tie rod assembly**

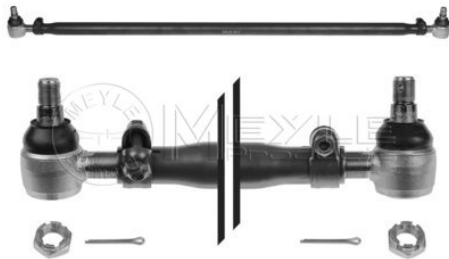

**Notes**

Pipe Ø [mm]  
Thread Measurement 2  
Thread Measurement 1  
Length [mm]  
Cone Size [mm]

Guide Rod  
Nut with lateral notches  
50  
with metric thread  
M30x1,5  
M24x1,5  
1652  
30  
Front Axle

Reinforced Version

**References**

81.46710.6112	81.46710.6354
81.46710.6163	81.46711.6725
81.46710.6165	81.46711.6820
81.46710.6198	81.46711.6849
81.46710.6353	

**Parts list**

036 020 0004/HD	Tie rod end
036 020 0005/HD	Tie rod end

**Application info**

F 90 (07/86-12/97)  
TGA (04/00--)

TGS (09/07--)  
TGX (09/07--)

**12-34 250 6860**  
81.46711.6921

**Tie rod assembly**



**Notes**

Pipe Ø [mm]  
Thread Measurement 2  
Thread Measurement 1  
Length [mm]  
Cone Size [mm]

Guide Rod  
Self-locking  
52  
with metric thread  
M30x1,5  
M24x1,5  
1679  
30  
Front Axle

**References**

81.46711.6773	81.46711.6860
81.46711.6791	81.46711.6861
81.46711.6848	81.46711.6862
81.46711.6858	81.46711.6863
81.46711.6859	81.46711.6921

**Parts list**

836 020 0003	Bolt, wheel alignment
12-36 020 0041	Tie rod end

**Application info**

M 2000 L (08/95--)  
M 2000 M (--12/05)  
NÜ (09/96-07/98)  
TGA (04/00--)

TGM (10/05--)  
TGS (09/07--)  
TGX (09/07--)



**Drag link**

**12-34 250 6374/HD**
**81.46610.6374**
**Notes**

	Push Rod
Pipe Ø [mm]	Nut with lateral notches 42 with metric thread
Thread Measurement 2	M30x1,5
Thread Measurement 1	M24x1,5
Length [mm]	1050
Cone Size [mm]	30
	Pitman Arm to track rod

**References**

81.46610.6019	82.46610.6189
81.46610.6374	82.46610.6190
82.46610.6080	

**Parts list**

036 020 0004/HD	Tie rod end
036 020 0005/HD	Tie rod end

**Application info**

EL (01/93-06/97)	NL (--07/98)
F 2000 (01/94-12/95)	NM (--03/97)
NG (--07/98)	

**Drag link**
**12-34 250 6656**
**81.46610.6656**
**Notes**

	Push Rod
Pipe Ø [mm]	Nut with lateral notches 48 with metric thread
Thread Measurement 2	M30x1,5
Thread Measurement 1	M24x1,5
Length [mm]	1070
Cone Size [mm]	for left-hand drive vehicles 30
	Pitman Arm to track rod

**References**

81.46610.6656	81.46610.6669
81.46610.6659	

**Parts list**

036 020 0004	Tie rod end
--------------	-------------

**Application info**

F 2000 (01/94-12/95)	F 90 (07/86-12/97)
----------------------	--------------------



**12-34 250 6767/HD**  
81.46610.6767

**Drag link**



**Notes**

Pipe Ø [mm]  
Thread Measurement 2  
Thread Measurement 1  
Length [mm]  
Cone Size [mm]

Push Rod  
Nut with lateral notches  
38  
with metric thread  
M30x1,5  
M24x1,5  
900  
30  
Steering Rod at steering arm

**References**

81.46610.6767  
81.46610.6768

81.46611.6014

**Parts list**

036 020 0004/HD  
036 020 0005/HD

Tie rod end  
Tie rod end

**Application info**

F 2000 (01/94-12/95)

5

**12-34 250 6197**  
81.46611.6197

**Drag link**



**Notes**

Pipe Ø [mm]  
Thread Measurement 2  
Thread Measurement 1  
Length [mm]  
Cone Size [mm]

Push Rod  
Nut with lateral notches  
52  
with metric thread  
M30x1,5  
M24x1,5  
993  
for left-hand drive vehicles  
30  
at steering arm

**References**

81.46610.6087  
81.46610.6808  
81.46610.6836  
81.46610.6837  
81.46611.6088  
81.46611.6096  
81.46611.6097

81.46611.6099  
81.46611.6132  
81.46611.6133  
81.46611.6136  
81.46611.6197  
81.46611.6198  
81.46611.6205

**Parts list**

12-36 020 0036

Tie rod end

**Application info**

TGA (04/00--)  
TGS (09/07--)

TGX (09/07--)

**12-34 250 6135**  
 81.46611.6199

**Drag link**
**Notes**

Push Rod	
Self-locking	
Pipe Ø [mm]	52
Thread Measurement 2	with metric thread
Thread Measurement 1	M30x1,5
Length [mm]	M24x1,5
Cone Size [mm]	967
	for left-hand drive vehicles
	30
	Pitman arm to 1st front axle

**References**

81.46610.6809	81.46611.6134
81.46610.6810	81.46611.6135
81.46610.6823	81.46611.6137
81.46610.6839	81.46611.6199
81.46611.6104	81.46611.6200
81.46611.6105	81.46611.6206
81.46611.6107	

**Parts list**

836 020 0006	Tie rod end
--------------	-------------

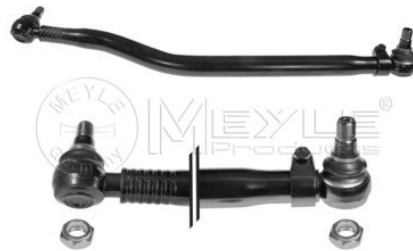
**Application info**

TGA (04/00--)	TGX (09/07--)
TGS (09/07--)	

**12-36 040 0009**  
 81.46611.6216

**Drag link**
**Notes**

Push Rod	
Nut with lateral notches	
Pipe Ø [mm]	48
Thread Measurement 2	with metric thread
Thread Measurement 1	M30x1,5
Length [mm]	M24x1,5
Cone Size [mm]	1040
	for left-hand drive vehicles
	30
	Pitman Arm to track rod

**References**

81.46610.6333	81.46610.6361
81.46610.6334	81.46610.6721
81.46610.6354	81.46610.6722
81.46610.6355	81.46610.6723
81.46610.6360	81.46611.6216

**Parts list**

036 020 0004	Tie rod end
--------------	-------------

**Application info**

F 2000 (01/94-12/95)	F 90 Unterflur (07/86-05/94)
F 90 (07/86-12/97)	



**12-34 250 6418**  
81.46710.6418

**Drag link**



**Notes**

Pipe Ø [mm]  
Thread Measurement 2  
Thread Measurement 1  
Length [mm]  
Cone Size [mm]

Push Rod  
Nut with lateral notches  
50  
with metric thread  
M30x1,5  
M24x1,5  
1795  
for left-hand drive vehicles  
30  
Pitman Arm to track rod

**References**

81.46710.6418

**Application info**

F 90 (07/86-12/97)

**12-34 035 0004**  
85.46610.6104

**Drag link**



**Notes**

Pipe Ø [mm]  
Thread Measurement 2  
Thread Measurement 1  
Length [mm]  
Cone Size [mm]

Push Rod  
Nut with lateral notches  
38  
with metric thread  
M28x1,5  
M18x1,5  
825  
for left-hand drive vehicles  
22  
Pitman Arm to track rod

**References**

81.46610.6004  
81.46610.6006  
81.46610.6753  
81.46610.6754

85.46610.6031  
85.46610.6104  
85.46610.6203

**Parts list**

036 020 0003

Tie rod end

**Application info**

L 2000 (10/93-07/97)

5

## Tie rod end

**036 020 0008**  
 81.95301.0079

### Notes

Thread Measurement 2	Nut with lateral notches with left-hand thread
Thread Measurement 1	M28x1,5L
Length [mm]	M18x1,5
Cone Size [mm]	106
	for left-/right-hand traffic
	22
	Front Axle

### References

81.95301.0079	81.95301.6315
81.95301.6139	81.95301.6329
81.95301.6222	81.95301.6359

### Counterpart

036 020 0003



### Application info

G (10/79-08/88)

## Tie rod end

**036 020 0004**  
 81.95301.6154

### Notes

Thread Measurement 2	Nut with lateral notches with right-hand thread
Thread Measurement 1	M30x1,5
Length [mm]	M24x1,5
Cone Size [mm]	125
	for left-/right-hand traffic
	30
	Front Axle

### References

81.95301.0016	81.95301.6156
81.95301.0084	81.95301.6194
81.95301.6048	81.95301.6224
81.95301.6049	81.95301.6234
81.95301.6053	81.95301.6242
81.95301.6061	81.95301.6274
81.95301.6090	81.95301.6278
81.95301.6112	81.95301.6308
81.95301.6126	81.95301.6312
81.95301.6143	81.95301.6350
81.95301.6149	81.95301.6352
81.95301.6154	

### Counterpart

036 020 0005



### Application info

 CLA (01/06--)  
 F 2000 (01/94-12/95)  
 F 90 (07/86-12/97)  
 F 90 Unterflur (07/86-05/94)

 M 2000 L (08/95--)  
 M 90 (08/88-06/96)  
 TGA (04/00--)



**036 020 0004/HD**  
81.95301.6154

**Tie rod end**



**Notes**

Thread Measurement 2  
Thread Measurement 1  
Length [mm]

Cone Size [mm]

Reinforced Version

Nut with lateral notches  
with right-hand thread  
M30x1,5  
M24x1,5  
125  
for left-/right-hand traffic  
30  
Front Axle

**References**

81.95301.0016	81.95301.6154
81.95301.0084	81.95301.6156
81.95301.6048	81.95301.6194
81.95301.6049	81.95301.6224
81.95301.6053	81.95301.6234
81.95301.6061	81.95301.6242
81.95301.6090	81.95301.6274
81.95301.6112	81.95301.6278
81.95301.6126	81.95301.6308
81.95301.6143	81.95301.6312
81.95301.6149	81.95301.6350

**Counterpart**  
036 020 0005/HD

**Application info**

CLA (01/06--)  
F 2000 (01/94-12/95)  
F 90 (07/86-12/97)  
F 90 Unterflur (07/86-05/94)

M 2000 L (08/95--)  
M 90 (08/88-06/96)  
TGA (04/00--)

**12-36 020 0032**  
81.95301.6263

**Tie rod end**



**Notes**

Thread Measurement 2  
Thread Measurement 1  
Length [mm]

Cone Size [mm]

Nut with lateral notches  
with right-hand thread  
M30x1,5  
M24x1,5  
158  
for left-/right-hand traffic  
30  
Front Axle

**References**

81.95301.6263

**Application info**

F 2000 (01/94-12/95)  
F 90 (07/86-12/97)

F 90 Unterflur (07/86-05/94)

**12-36 020 0039**  
 81.95301.6270

**Tie rod end**
**Notes**

Thread Measurement 2 M24x1,5  
 Thread Measurement 1 M30x1,5  
 Length [mm] 141  
 Cone Size [mm] 26  
 for left-/right-hand traffic  
 Front Axle

**References**

81.95301.6270

**Application info**

EL (01/93-06/97) NG (--07/98)  
 HOCL (01/85-05/09) NL (--07/98)  
 M 2000 L (08/95--) NM (--03/97)  
 M 2000 M (--12/05) TGM (10/05--)

**Tie rod end**
**036 020 0001**  
 81.95301.6272

**Notes**

Thread Measurement 2 M30x1,5  
 Thread Measurement 1 M20x1,5  
 Length [mm] 114  
 Cone Size [mm] 26  
 for left-/right-hand traffic  
 Front Axle

**References**

81.95301.0014 81.95301.6239  
 81.95301.0064 81.95301.6272  
 81.95301.6067 90.80415.3111  
 81.95301.6162

**Counterpart**

036 020 0002

**Application info**

F 2000 (01/94-12/95) M 2000 L (08/95--)  
 F 90 (07/86-12/97) M 90 (08/88-06/96)  
 F 90 Unterflur (07/86-05/94)



**036 020 0002**  
81.95301.6273

**Tie rod end**



**Notes**

Thread Measurement 2  
Thread Measurement 1  
Length [mm]  
Cone Size [mm]

Nut with lateral notches  
with left-hand thread  
M30x1,5  
M20x1,5  
114  
for left-/right-hand traffic  
26  
Front Axle

**References**

81.95301.0013	81.95301.6273
81.95301.0074	90.80415.3107
81.95301.6068	90.80415.3113
81.95301.6163	

**Counterpart**  
036 020 0001

**Application info**

F 2000 (01/94-12/95)  
F 90 (07/86-12/97)  
F 90 Unterflur (07/86-05/94)

M 2000 L (08/95--)  
M 90 (08/88-06/96)

5

**036 020 0005**  
81.95301.6275

**Tie rod end**



**Notes**

Thread Measurement 2  
Thread Measurement 1  
Length [mm]  
Cone Size [mm]

Nut with lateral notches  
with left-hand thread  
M30x1,5  
M24x1,5  
125  
for left-/right-hand traffic  
30  
Front Axle

**References**

81.95301.0015	81.95301.6152
81.95301.6030	81.95301.6155
81.95301.6043	81.95301.6167
81.95301.6091	81.95301.6179
81.95301.6120	81.95301.6237
81.95301.6125	81.95301.6275

**Counterpart**  
036 020 0004

**Application info**

CLA (01/06--)  
F 90 (07/86-12/97)  
F 90 Unterflur (07/86-05/94)

M 90 (08/88-06/96)  
TGA (04/00--)



**Tie rod end**

**036 020 0005/HD**
**81.95301.6275**
**Notes**

Thread Measurement 2	Nut with lateral notches with left-hand thread
Thread Measurement 1	M30x1,5
Length [mm]	M24x1,5
Cone Size [mm]	125
Reinforced Version	for left-/right-hand traffic
	30
	Front Axle

**References**

81.95301.0015	81.95301.6152
81.95301.6030	81.95301.6155
81.95301.6043	81.95301.6167
81.95301.6091	81.95301.6179
81.95301.6120	81.95301.6237
81.95301.6125	81.95301.6275

**Counterpart**

036 020 0004/HD

**Application info**

 CLA (01/06--)  
 F 90 (07/86-12/97)  
 F 90 Unterflur (07/86-05/94)

 M 90 (08/88-06/96)  
 TGA (04/00--)

**Tie rod end**
**12-36 020 0041**
**81.95301.6288**
**Notes**

Thread Measurement 2	Nut with lateral notches with right-hand thread
Thread Measurement 1	M30x1,5
Length [mm]	M24x1,5
Cone Size [mm]	120
	for left-/right-hand traffic
	30
	Steering Rod at steering arm

**References**

81.95301.6288

**Application info**

 NÜ (09/96-07/98)  
 TGA (04/00--)  
 TGM (10/05--)

 TGS (09/07--)  
 TGX (09/07--)



**036 020 0015**  
81.95301.6304

**Tie rod end**



**Notes**

Thread Measurement 2  
Thread Measurement 1  
Length [mm]  
Cone Size [mm]

Nut with lateral notches  
with left-hand thread  
M24x1,5  
M16x1,5  
104  
for left-/right-hand traffic  
20  
Front Axle

**References**

81.85301.0076  
81.95301.0078

81.95301.6141  
81.95301.6304

**Counterpart**

036 020 0016

**Application info**

G (10/79-08/88)  
G 90 (09/87-05/95)

L 2000 (10/93-07/97)  
TGA (04/00--)

**036 020 0016**  
81.95301.6321

**Tie rod end**



**Notes**

Thread Measurement 2  
Thread Measurement 1  
Length [mm]  
Cone Size [mm]

Nut with lateral notches  
with right-hand thread  
M24x1,5  
M16x1,5  
104  
for left-/right-hand traffic  
20  
Front Axle

**References**

81.95301.0077  
81.95301.0388  
81.95301.6134

81.95301.6142  
81.95301.6303  
81.95301.6321

**Counterpart**

036 020 0015

**Application info**

G (10/79-08/88)  
G 90 (09/87-05/95)

L 2000 (10/93-07/97)  
TGA (04/00--)

5

**036 020 0003**  
 81.95301.6328

**Tie rod end**
**Notes**

Thread Measurement 2	Nut with lateral notches with right-hand thread
Thread Measurement 1	M28x1,5
Length [mm]	M18x1,5
Cone Size [mm]	106
	for left-/right-hand traffic
	22
	Front Axle

**References**

81.95301.6060	81.95301.6249
81.95301.6135	81.95301.6328
81.95301.6140	81.95301.6358

**Parts list**

036 030 0041	Drag link
--------------	-----------

**Counterpart**

036 020 0008

**Application info**

G (10/79-08/88)	L 2000 (10/93-07/97)
G 90 (09/87-05/95)	M 2000 L (08/95--)

**Hydraulic pump, P/S**
**12-34 471 0001**  
 81.47101.6031

**Notes**

Thread Measurement 2	Hydraulic
Number of ports	Steel
Thread Measurement 1	M26x1,5
Operating Pressure [bar]	2
	M18x1,5
	130
	Clockwise rotation

**References**

81.47101.6000	81.47101.6040
81.47101.6001	81.47101.6051
81.47101.6031	81.47101.6169

**Application info**

F 2000 (01/94-12/95)	LION'S COACH (09/95--)
F 90 (07/86-12/97)	LION'S COMFORT (09/96--)
F 90 Unterflur (07/86-05/94)	LION'S STAR (01/93-09/96)



**12-34 631 0001**  
81.47101.6136

**Hydraulic pump, P/S**



**Notes**

Thread Measurement 2  
Number of ports  
Thread Measurement 1  
Operating Pressure [bar]

Hydraulic  
Cast Aluminium  
M26x1,5  
2  
M18x1,5  
150  
Anti-clockwise rotation

**References**

81.47101.6121  
81.47101.6136

81.47101.6161

**Application info**

SL (05/80-04/87)

TGA (04/00--)

**12-34 471 0003**  
81.47101.6137

**Hydraulic pump, P/S**



**Notes**

Thread Measurement 2  
Number of ports  
Thread Measurement 1  
Operating Pressure [bar]

Hydraulic  
Cast Aluminium  
M26x1,5  
2  
M18x1,5  
150  
Clockwise rotation

**References**

81.47101.6137  
81.47101.6162  
81.47101.6181

81.47101.9137  
81.47101.9162

**Application info**

F 2000 (01/94-12/95)  
F 90 (07/86-12/97)  
F 90 Unterflur (07/86-05/94)  
LION'S COACH (09/95--)

LION'S COMFORT (09/96--)  
LION'S STAR (01/93-09/96)  
TGA (04/00--)

**12-34 631 0002**  
81.47101.6189

**Hydraulic pump, P/S**



**Notes**

Thread Measurement 2  
Number of ports  
Thread Measurement 1  
Operating Pressure [bar]

Hydraulic  
Cast Aluminium  
M26x1,5  
2  
M18x1,5  
130  
Clockwise rotation

**References**

81.47101.6102  
81.47101.6108

81.47101.6189



## Hydraulic pump, P/S

**12-34 631 0002**  
 81.47101.6189

### Application info

EL (01/93-06/97)	NG (--07/98)
EM (08/87-06/97)	NL (--07/98)
F 90 (07/86-12/97)	NM (--03/97)
LION'S COACH (09/95--)	NÜ (09/96-07/98)
LION'S STAR (01/93-09/96)	

## P/S fluid reservoir

**12-34 632 0002**  
 81.47301.6048

### Notes

with lid

### References

81.47301.6048



### Application info

F 2000 (01/94-12/95)	TGS (09/07--)
TGA (04/00--)	TGX (09/07--)



**12-34 026 0001**  
81.32620.0043

**Gear shift knob**



**Notes**

Width 2 [mm]  
Width 1 [mm]  
Number of ports  
Length [mm]

Black  
ZF Transmission  
65  
47  
6  
155

**References**

81.32620.0039  
81.32620.0043

81.32620.0085

**Application info**

TGA (04/00--)  
TGS (09/07--)

TGX (09/07--)

**12-34 026 0000**  
81.32620.0049

**Gear shift knob**



**Notes**

Width 2 [mm]  
Width 1 [mm]  
Number of ports  
Length [mm]

Black  
Silver  
ZF Transmission  
65  
47  
4  
150

**References**

81.32620.0049

**Application info**

TGA (04/00--)  
TGS (09/07--)

TGX (09/07--)

**12-34 026 0004**  
81.97010.6010

**Gear shift knob**



**Notes**

Number of ports  
Length [mm]

Black  
Manual Transmission  
2  
128

**References**

81.97010.6010



**12-34 026 0004**  
 81.97010.6010

**Gear shift knob**
**Application info**

 F 2000 (01/94-12/95)  
 F 90 (07/86-12/97)  
 M 2000 L (08/95--)

 M 2000 M (--12/05)  
 M 90 (08/88-06/96)

**12-34 026 0003**  
 81.97010.6011

**Gear shift knob**
**Notes**

	Black
Width 2 [mm]	67
Width 1 [mm]	50
Number of ports	3
Length [mm]	115

**References**

81.97010.6011

**Application info**

 F 2000 (01/94-12/95)  
 F 90 (07/86-12/97)  
 F 90 Unterflur (07/86-05/94)  
 L 2000 (10/93-07/97)

 M 2000 L (08/95--)  
 M 2000 M (--12/05)  
 M 90 (08/88-06/96)

**12-34 255 0001**  
 81.25509.0020

**Column switch**
**Notes**

	Black with light dimmer function with indicator function
Number of Poles	9
Voltage [V]	24

**References**

81.25509.0020

**Application info**

 EL (01/93-06/97)  
 F 90 (07/86-12/97)  
 F 90 Unterflur (07/86-05/94)  
 M 90 (08/88-06/96)  
 NG (--07/98)  
 NL (--07/98)  
 NM (--03/97)

 R (05/85-01/93)  
 SD (04/74-04/94)  
 SG (07/76-06/97)  
 SL II (--04/94)  
 SÜ (--06/97)  
 ÜL (09/89-09/96)



**12-34 255 0002**  
81.25509.0124

**Column switch**



**Notes**

Black  
with wipe interval function  
with wipe-wash function  
with light dimmer function  
with indicator function

Number of Poles  
Voltage [V]

17  
24

**References**

81.25509.0028  
81.25509.0067  
81.25509.0093

81.25509.0119  
81.25509.0124

**Application info**

CLA (01/06--)  
EL (01/93-06/97)  
F 2000 (01/94-12/95)  
F 90 (07/86-12/97)  
F 90 Unterflur (07/86-05/94)  
L 2000 (10/93-07/97)  
LION'S COACH (09/95--)

M 2000 L (08/95--)  
M 2000 M (--12/05)  
M 90 (08/88-06/96)  
NG (--07/98)  
NL (--07/98)  
NÜ (09/96-07/98)  
TGA (04/00--)

**12-34 255 0009**  
81.25509.0125

**Column switch**



**Notes**

Black  
172  
6  
24

Cable Length [mm]  
Number of Poles  
Voltage [V]

**References**

81.25509.0125

**Application info**

TGA (04/00--)  
TGL (04/05--)  
TGM (10/05--)

TGS (09/07--)  
TGX (09/07--)

6



**12-34 255 0010**  
 81.25509.0126

**Column switch**
**Notes**

Black  
 with cruise control

Cable Length [mm] 155  
 Number of Poles 6  
 Voltage [V] 24

**References**

81.25509.0126

**Application info**

LION'S CITY (08/04--)  
 LION'S COACH (09/95--)  
 LION'S COMFORT (09/96--)

LION'S STAR (01/93-09/96)  
 TGA (04/00--)  
 TGS (09/07--)

**12-34 255 0003**  
 81.25509.0144

**Column switch**
**Notes**

Grey  
 with horn  
 with wipe interval function  
 with wipe-wash function  
 with light dimmer function  
 with indicator function

Number of Poles 13  
 Voltage [V] 24

**References**

81.25509.0085 81.25509.0127  
 81.25509.0118 81.25509.0128  
 81.25509.0123 81.25509.0144

**Application info**

LION'S COACH (09/95--)  
 LION'S STAR (01/93-09/96)  
 NG (--07/98)  
 NL (--07/98)

NÜ (09/96-07/98)  
 TGA (04/00--)  
 TGL (04/05--)  
 TGM (10/05--)



**12-12 319 0000**  
81.61910.0011

**Cabin air filter**



**Notes**

Height [mm]	31
Width [mm]	187
Length [mm]	401.8
	Filter Insert
	Particulate Filter

**References**

81.61910.0011

**Application info**

F 2000 (01/94-12/95)  
F 90 (07/86-12/97)  
F 90 Unterflur (07/86-05/94)  
L 2000 (10/93-07/97)

LION'S COMFORT (09/96--)  
M 2000 L (08/95--)  
M 2000 M (--12/05)  
M 90 (08/88-06/96)

**12-12 319 0003**  
81.61910.0018

**Cabin air filter**



**Notes**

Height [mm]	70
Width [mm]	177
Length [mm]	466.5
	Filter Insert
	Particulate Filter

**References**

81.61910.0018

**Application info**

TGA (04/00--)  
TGL (04/05--)

TGS (09/07--)  
TGX (09/07--)

**12-12 320 0008**  
81.61910.0019

**Cabin air filter**



**Notes**

Height [mm]	70
Width [mm]	177
Length [mm]	466.5
	Filter Insert
	Activated Carbon Filter

**References**

81.61910.0019



### Cabin air filter

**12-12 320 0008**  
81.61910.0019

**+** Application info

TGA (04/00--)  
TGL (04/05--)  
TGM (10/05--)

TGS (09/07--)  
TGX (09/07--)

### Cabin air filter

**12-12 319 0009**  
81.77910.0012

**Notes**

Height [mm] 30  
Width [mm] 237  
Length [mm] 448  
Particulate Filter  
Filter Insert

**References**

36.77910.0020 81.77972.0155  
81.77910.0012 83.77910.0526  
81.77910.0027



**Application info**

LION'S CITY (08/04--)  
NG (--07/98)  
NL (--07/98)

NM (--03/97)  
NÜ (09/96-07/98)  
SÜ (--06/97)

### Cabin air filter

**12-12 319 0001**  
85.61950.0025

**Notes**

Height [mm] 40  
Width [mm] 159  
Length [mm] 361  
Filter Insert  
Particulate Filter

**References**

85.61950.0025



**Application info**

CLA (01/06--)

L 2000 (10/93-07/97)



**12-14 910 0001**  
81.61851.6023

**Latch, driver cabine**



**References**

81.61851.6019	81.61851.6029
81.61851.6023	

**Application info**

F 2000 (01/94-12/95)	M 90 (08/88-06/96)
F 90 (07/86-12/97)	TGA (04/00--)
M 2000 M (--12/05)	

**12-34 210 0348**  
81.96210.0348

**Hinge, driver cab**



**Notes**

Inner Diameter [mm]	22
Outer Diameter [mm]	58.5
Height [mm]	47.5
	Left and right
	Front

**References**

81.96210.0340	81.96210.0349
81.96210.0348	

**Application info**

LION'S COACH (09/95--)	M 90 (08/88-06/96)
LION'S STAR (01/93-09/96)	TGA (04/00--)
M 2000 M (--12/05)	

**12-34 210 0403**  
81.96210.0462

**Hinge, driver cab**



**Notes**

Inner Diameter [mm]	14
Outer Diameter [mm]	38
Outer Diameter [mm]	30
Height [mm]	48
	Left and right
	Rear

**References**

81.96210.0369	81.96210.0462
---------------	---------------



**Hinge, driver cab**
**12-34 210 0403**  
 81.96210.0462

**Application info**

CLA (01/06--)	TGA (04/00--)
F 2000 (01/94-12/95)	TGL (04/05--)
F 90 (07/86-12/97)	TGM (10/05--)
L 2000 (10/93-07/97)	TGS (09/07--)
M 2000 L (08/95--)	TGX (09/07--)
M 2000 M (--12/05)	

**Spacer, driver cab stabiliser**
**12-34 089 0001**  
 81.90713.0909

**Notes**

Thickness [mm]                      6

**References**

81.90712.0844                      81.90713.0909

**Application info**

F 2000 (01/94-12/95)                      F 90 (07/86-12/97)

**Spacer, driver cab stabiliser**
**12-34 210 0401**  
 81.96101.0638

**Notes**

Thickness [mm]                      4

**References**

81.96101.0638

**Application info**

 F 2000 (01/94-12/95)                      F 90 Unterflur (07/86-05/94)  
 F 90 (07/86-12/97)



**12-34 210 0400**  
81.96210.0400

**Bushing, driver cab suspension**



**Notes**

Inner Diameter 1 [mm]	16
Outer Diameter 2 [mm]	64
Outer Diameter 1 [mm]	50
Height 1 [mm]	29
	Left and right
	Front

**References**

81.96210.0400

**Application info**

F 90 (07/86-12/97)  
F 90 Unterflur (07/86-05/94)

M 90 (08/88-06/96)

**12-34 210 0437**  
81.96210.0437

**Bushing, driver cab suspension**



**Notes**

Inner Diameter 1 [mm]	11
Outer Diameter 2 [mm]	70
Outer Diameter 1 [mm]	63
Height 1 [mm]	68
	Left and right
	Front

**References**

81.96210.0424                      81.96210.0437

**Application info**

F 2000 (01/94-12/95)

F 90 (07/86-12/97)

**12-34 210 0409**  
85.41715.0006

**Bushing, driver cab suspension**



**Notes**

Inner Diameter 1 [mm]	17
Outer Diameter 1 [mm]	75
Height 1 [mm]	22
	Left and right

**References**

85.41715.0006

**Application info**

TGA (04/00--)  
TGS (09/07--)

TGX (09/07--)

**12-34 210 0404**  
 85.94299.0015

**Bushing, driver cab suspension**
**Notes**

Inner Diameter 1 [mm]	13
Outer Diameter 1 [mm]	22
Height 1 [mm]	79.5
	Left and right
	Rear

**References**

85.94299.0015

**Application info**

TGA (04/00--)	TGS (09/07--)
TGL (04/05--)	TGX (09/07--)
TGM (10/05--)	

**Bushing, driver cab suspension**
**12-34 210 0405**  
 85.96020.0004

**Notes**

Inner Diameter 1 [mm]	22
Outer Diameter 1 [mm]	53
Height 1 [mm]	42
	Left and right
	Rear

**References**

85.96020.0004

**Application info**

TGA (04/00--)	TGS (09/07--)
TGL (04/05--)	TGX (09/07--)
TGM (10/05--)	

**Bushing, driver cab suspension**
**12-34 210 0406**  
 85.96210.0019

**Notes**

Inner Diameter 1 [mm]	16.5
Outer Diameter 1 [mm]	60
Height 2 [mm]	80
Height 1 [mm]	64
	Left and right
	Front

**References**

85.96210.0019





**12-34 210 0406**  
85.96210.0019

**Bushing, driver cab suspension**

**Application info**

TGA (04/00--)  
TGS (09/07--)

TGX (09/07--)

**12-34 210 0408**  
85.96210.0021

**Bushing, driver cab suspension**



**References**

85.96210.0021

**Application info**

TGA (04/00--)  
TGL (04/05--)

TGM (10/05--)

**12-34 210 0515**  
81.96210.0515

**Rubber stop, cabin**



**Notes**

Outer Diameter [mm]	50
Height [mm]	36
Thread Size	M10x1,5
Thread Length [mm]	18

**References**

81.96210.0482	81.96210.0515
---------------	---------------

**Application info**

E 2000 (05/00--)  
F 2000 (01/94-12/95)

M 2000 M (--12/05)



**12-34 210 0402**  
 81.96503.0129

**Seal, driver cab stabiliser**
**References**  
 81.96503.0129

**Application info**

 F 2000 (01/94-12/95)  
 F 90 (07/86-12/97)

F 90 Unterflur (07/86-05/94)

**12-34 058 0003**  
 81.41700.6095

**Repair kit, driver cab mounting**
**References**  
 81.41700.6095

**Application info**

 F 2000 (01/94-12/95)  
 F 90 (07/86-12/97)

F 90 Unterflur (07/86-05/94)

**12-34 058 0001**  
 81.41715.6013

**Repair kit, driver cab mounting**
**Notes**

 with bush  
 with gaskets/seals

**References**  
 81.41715.6013



**12-34 058 0001**  
81.41715.6013

**Repair kit, driver cab mounting**

**Application info**

TGA (04/00--)  
TGS (09/07--)

TGX (09/07--)

**12-34 058 0002**  
81.41715.6014

**Repair kit, driver cab mounting**



**References**

81.41715.6014

**Application info**

TGA (04/00--)

**12-34 058 0004**  
81.96210.0407

**Repair kit, driver cab mounting**



**References**

81.96210.0362

81.96210.0407

**Application info**

F 2000 (01/94-12/95)

F 90 (07/86-12/97)

**12-14 910 0102**  
 81.41723.6114

**Tilt pump, driver cab**
**References**

81.41723.6059	81.41723.6114
81.41723.6103	81.41723.9114

**Application info**

F 2000 (01/94-12/95)	M 2000 L (08/95--)
F 90 (07/86-12/97)	M 2000 M (--12/05)
L 2000 (10/93-07/97)	

**12-14 910 0100**  
 85.41723.6020

**Tilt pump, driver cab**
**References**

85.41723.6011	85.41723.6020
---------------	---------------

**Application info**

TGA (04/00--)	TGM (10/05--)
---------------	---------------

**12-14 910 0005**  
 81.41723.6123

**Tilt cylinder, driver cab**
**Notes**

Outer Thread [mm]	M12x1,5
Pressure [bar]	250
Outer Diameter [mm]	50
Length 2 [mm]	1545
Length 1 [mm]	890
Stroke [mm]	655

**References**

81.41723.6123	83.41723.6123
---------------	---------------

**Application info**

TGA (04/00--)



**12-14 910 0004**

81.41723.6124

**Tilt cylinder, driver cab**



**References**

81.41723.6124

83.41723.6124

**Application info**

TGA (04/00-)

**12-34 920 1002**

81.74821.0109

**Gas spring, front hood**



**Notes**

Eject Force [N]

260

Length [mm]

580

Stroke [mm]

280

**References**

81.74821.0109

**Application info**

F 2000 (01/94-12/95)

F 90 (07/86-12/97)

**12-34 830 0101**

81.25260.6105

**Side marker**



**Notes**

Yellow  
with bulb  
Left and right

**References**

81.25260.6105



**12-34 830 0101**  
 81.25260.6105

**Side marker**
**Application info**

 F 2000 (01/94-12/95)  
 L 2000 (10/93-07/97)  
 M 2000 L (08/95--)  
 M 2000 M (--12/05)

 TGA (04/00--)  
 TGS (09/07--)  
 TGX (09/07--)

**12-34 910 0005**  
 81.62641.0099

**Door handle**
**Notes**

 Black  
 Left

**References**

81.62641.0099

**Application info**

F 2000 (01/94-12/95)

M 2000 M (--12/05)

**12-34 910 0006**  
 81.62641.0100

**Door handle**
**Notes**

 Black  
 Right

**References**

81.62641.0100

**Application info**

F 2000 (01/94-12/95)

M 2000 M (--12/05)



**12-34 910 0001**

81.62641.6085

**Door handle**



**Notes**

Black  
without lock barrel  
Left

**References**

81.62641.6085

**Counterpart**

12-34 910 0002

**Application info**

TGA (04/00--)  
TGL (04/05--)  
TGM (10/05--)

TGS (09/07--)  
TGX (09/07--)

**12-34 910 0002**

81.62641.6086

**Door handle**



**Notes**

Black  
without lock barrel  
Right

**References**

81.62641.6086

**Counterpart**

12-34 910 0001

**Application info**

TGA (04/00--)  
TGL (04/05--)  
TGM (10/05--)

TGS (09/07--)  
TGX (09/07--)

**12-34 910 0003**

81.97100.6099

**Door handle**



**Notes**

Black  
with key  
with lock barrel  
Left and right

**References**

81.97100.6079

81.97100.6099



**Door handle**
**12-34 910 0003**  
 81.97100.6099

**Application info**

 F 2000 (01/94-12/95)  
 F 90 (07/86-12/97)  
 F 90 Unterflur (07/86-05/94)

 M 2000 M (--12/05)  
 M 90 (08/88-06/96)

**Door lock**
**12-34 910 0009**  
 81.62680.6095

**Notes**

Left

**References**

81.62680.6095

**Counterpart**

12-34 910 0008

**Application info**

 F 2000 (01/94-12/95)  
 F 90 (07/86-12/97)

 F 90 Unterflur (07/86-05/94)  
 M 90 (08/88-06/96)

**Door lock**
**12-34 910 0008**  
 81.62680.6096

**Notes**

Right

**References**

81.62680.6096

**Counterpart**

12-34 910 0009

**Application info**

 F 2000 (01/94-12/95)  
 F 90 (07/86-12/97)

 F 90 Unterflur (07/86-05/94)  
 M 90 (08/88-06/96)



**12-34 899 0002**  
81.97100.6034

**Lock cylinder set**



**References**

81.46433.6006	81.97100.6034
81.46433.6011	81.97100.6095

**Application info**

CLA (01/06--)	M 90 (08/88-06/96)
EL (01/93-06/97)	NG (--07/98)
EM (08/87-06/97)	NL (--07/98)
F 2000 (01/94-12/95)	NM (--03/97)
F 90 (07/86-12/97)	NÜ (09/96-07/98)
F 90 Unterflur (07/86-05/94)	R (05/85-01/93)
L 2000 (10/93-07/97)	SG (07/76-06/97)
LION'S COACH (09/95--)	SM (11/87-02/95)
LION'S STAR (01/93-09/96)	SÜ (--06/97)
M 2000 L (08/95--)	ÜL (09/89-09/96)
M 2000 M (--12/05)	

**12-34 910 0010**  
81.62640.6055

**Window lifter**



**Notes**

Electric  
Left

**References**

81.62640.6045	81.62640.6055
81.62640.6049	

**Counterpart**

12-34 910 0011

**Application info**

F 2000 (01/94-12/95)	M 2000 M (--12/05)
----------------------	--------------------

6



**12-34 910 0011**  
 81.62640.6056

**Window lifter**
**Notes**

 Electric  
 Right

**References**

 81.62640.6046  
 81.62640.6050

81.62640.6056

**Counterpart**

12-34 910 0010

**Application info**

F 2000 (01/94-12/95)

M 2000 M (--12/05)

**12-34 870 0004**  
 81.26485.6008

**Windshield washer pump**
**Notes**

 Mono Pump  
 Electric  
 24

Voltage [V]

**References**

81.26485.6008

**Application info**

 EL (01/93-06/97)  
 EM (08/87-06/97)  
 LION'S COACH (09/95--)  
 LION'S STAR (01/93-09/96)  
 NG (--07/98)  
 NM (--03/97)

 NÜ (09/96-07/98)  
 SG (07/76-06/97)  
 SL (05/80-04/87)  
 SR (10/75-11/86)  
 ÜL (09/89-09/96)

**12-34 870 0002**  
 81.26485.6027

**Windshield washer pump**
**Notes**

 Dual Pump  
 Grey  
 Black  
 Electric  
 24

Voltage [V]

**References**

81.26485.6027

81.26485.6030





**12-34 870 0002**  
**81.26485.6027**

**Windshield washer pump**

**Application info**

CLA (01/06--)  
F 2000 (01/94-12/95)  
F 90 (07/86-12/97)  
F 90 Unterflur (07/86-05/94)  
L 2000 (10/93-07/97)

M 2000 L (08/95--)  
M 2000 M (--12/05)  
M 90 (08/88-06/96)  
NÜ (09/96-07/98)

**12-34 870 0001**  
**81.26485.6033**

**Windshield washer pump**



**Notes**

Dual Pump  
Black  
Electric  
24

Voltage [V]

**References**

81.26485.6032 81.26485.6033

**Application info**

NG (--07/98)  
NL (--07/98)  
NÜ (09/96-07/98)  
TGA (04/00--)

TGL (04/05--)  
TGM (10/05--)  
TGS (09/07--)  
TGX (09/07--)

**029 100 4071**  
**81.26440.0049**

**Wiper Blade**



**Notes**

Length [in]  
Length [mm]

Beam wiper blade  
40  
1000  
Front

**References**

81.26440.0049 81.26440.6027  
81.26440.6016 83.26440.0001

**Application info**

LION'S COACH (09/95--)  
R (05/85-01/93)

SR (10/75-11/86)  
ÜL (09/89-09/96)

**029 600 2470**
**81.26440.0065**
**Wiper Blade**
**Notes**

	Beam wiper blade
Length [in]	24
Length [mm]	600
	Front

**References**

81.26440.0053	85.20000.9975
81.26440.0065	85.26440.0046
81.26440.6034	

**Application info**

F 2000 (01/94-12/95)	M 2000 M (--12/05)
F 90 (07/86-12/97)	M 90 (08/88-06/96)
F 90 Unterflur (07/86-05/94)	TGA (04/00--)

**Wiper Blade**
**029 700 2870**
**81.26440.6006**
**Notes**

	Beam wiper blade
Length [in]	28
Length [mm]	700
	Front

**References**

81.26440.0029	81.26440.6035
81.26440.0043	81.70701.0331
81.26440.6006	84.26440.0003

**Application info**

TGA (04/00--)	TGS (09/07--)
TGL (04/05--)	TGX (09/07--)
TGM (10/05--)	

**Wiper Blade**
**029 650 2670**
**Notes**

	Beam wiper blade
Length [in]	26
Length [mm]	650
	Front





**029 650 2670**

**Wiper Blade**

**+ Application info**

TGA (04/00--)  
TGL (04/05--)  
TGM (10/05--)

TGS (09/07--)  
TGX (09/07--)

**6**

## Multifunction relay

**12-34 830 0006**

81.25902.0155

### Notes

Rated current [A]	70
	Clamp 87
	Directional Contact
Height [mm]	42
Width [mm]	27
Operating voltage [V]	24
Length [mm]	27
Number of Poles	4
	with retaining strap

### References

81.25902.0155	81.25902.0274
---------------	---------------



### Application info

E 2000 (05/00--)	M 2000 L (08/95--)
F 2000 (01/94-12/95)	M 2000 M (--12/05)
L 2000 (10/93-07/97)	TGA (04/00--)

## Multifunction relay

**12-34 830 0005**

81.25902.0474

### Notes

Rated current [A]	20
	ABS
	Indicator
	with headlight flasher
Height [mm]	40
Width [mm]	27
Operating voltage [V]	24
Length [mm]	27
Number of Poles	5

### References

81.25902.0460	81.25902.0474
---------------	---------------



### Application info

E 2000 (05/00--)	M 2000 M (--12/05)
EL (01/93-06/97)	M 90 (08/88-06/96)
EM (08/87-06/97)	SD (04/74-04/94)
F 2000 (01/94-12/95)	SL (05/80-04/87)
F 90 (07/86-12/97)	SM (11/87-02/95)
F 90 Unterflur (07/86-05/94)	SR (10/75-11/86)
G 90 (09/87-05/95)	SÜ (--06/97)
L 2000 (10/93-07/97)	TGA (04/00--)
LION'S CITY (08/04--)	TGL (04/05--)
LION'S COACH (09/95--)	TGM (10/05--)
LION'S COMFORT (09/96--)	TGS (09/07--)
LION'S STAR (01/93-09/96)	TGX (09/07--)
M 2000 L (08/95--)	ÜL (09/89-09/96)



MEYLE no.	Ref. no.	Page
<b>MAN</b>		
012 094 0024	81.08304.0049 81.08304.0055 81.08304.0056	16
014 018 0009	51.05504.0048 51.05504.0049 51.05504.0068 51.05504.0084 51.05504.0085 51.05504.0086 51.05504.0091 81.00000.0239 81.05504.0038 81.05504.0040	14
014 018 0015	51.05500.6073 51.05504.0105	13
014 323 0008	51.12503.0051 51.12503.6000	26
025 290 4827	81.50820.5074 81.50820.5085 81.50820.6040 81.50820.6043 81.50820.6054 81.50820.6063	102
025 290 8730	81.50820.6030 81.50820.6056	100
025 290 8730/S	81.50820.6030 81.50820.6056	102
025 290 8826	81.50820.5023 81.50820.5025 81.50820.5029 81.50820.5079 81.50820.6006 81.50820.6020 81.50820.6042	99
025 290 8826/S	81.50820.5023 81.50820.5025 81.50820.5029 81.50820.5079 81.50820.6006 81.50820.6020 81.50820.6042	100
025 290 9530	81.50820.5017 81.50820.6008 81.50820.6022	98
025 291 1328	81.50820.5006 81.50820.5007	101

MEYLE no.	Ref. no.	Page
<b>MAN</b>		
	81.50820.5020 81.50820.5040 81.50820.5047 81.50820.5060 81.50820.5066 81.50820.5068 81.50820.5091 81.50820.6000 81.50820.6002 81.50820.6004 81.50820.6014 81.50820.6016 81.50820.6017 81.50820.6025 81.50820.6034 81.50820.6035 81.50820.6036 81.50820.6046	
025 291 1428	81.50820.5007 81.50820.5041 81.50820.5048 81.50820.5061 81.50820.5069 81.50820.5092 81.50820.6001 81.50820.6003 81.50820.6005 81.50820.6015 81.50820.6017 81.50820.6026	99
025 291 3130	81.50820.5072 81.50820.5080 81.50820.6031 81.50820.6041 81.50820.6051	101
028 283 0000	51.06402.0058 51.06402.0060 51.06402.0063 51.06402.0066	61
029 100 4071	81.26440.0049 81.26440.6016 81.26440.6027 83.26440.0001	222
029 600 2470	81.26440.0053 81.26440.0065 81.26440.6034	223





MEYLE no.	Ref. no.	Page
<b>MAN</b>		
	85.20000.9975 85.26440.0046	
029 650 2670	-	223
029 700 2870	81.26440.0029 81.26440.0043 81.26440.6006 81.26440.6035 81.70701.0331 84.26440.0003	223
033 020 0022	51.06500.6282 51.06500.6384 51.06500.6387 51.06500.9282	54
033 020 0043	51.06500.6426	55
033 020 0048	51.06500.6479 51.06500.9479	56
034 003 1024	51.02130.0013 51.93020.0236	6
034 005 1004	51.04201.6111	5
034 005 1015	51.04202.5034	4
034 009 0003	81.11101.6012 81.11101.6016 81.12102.0002	26
034 009 0015	51.12150.7003 51.12150.7005 81.12150.6003 81.12150.6013	23
034 013 0001	51.54105.6006	115
034 013 0006	51.54114.6023 51.54114.6024 51.54114.6035 51.54114.6045 51.54114.6047 51.54114.6049 51.54114.6054	114
034 013 0008	81.54124.6006	114
034 015 0005	81.25601.6024	10
034 018 1002	51.05601.0148	15
034 026 0015	81.95301.0038 81.95301.6016 81.95301.6169 81.95301.6172 81.95301.6176 81.95301.6235	137
034 026 0017	81.95301.6063 81.95301.6131	137

MEYLE no.	Ref. no.	Page
<b>MAN</b>		
	81.95301.6171 81.95301.6174	
034 026 0018	81.95301.6064 81.95301.6130 81.95301.6170 81.95301.6173	136
034 026 0025	81.32735.6011 81.32735.6035 81.32735.6039 81.32735.6040	139
034 026 0027	81.52170.6064 81.52170.6128	130
034 026 0029	81.52170.6095 81.52170.6097	138
034 026 0030	81.32734.6001 81.52170.6120	133
034 026 0032	81.32550.0003	137
034 029 0034	81.30725.6104	146
034 035 0001	81.35710.0045	179
034 035 0003	81.35710.0044	179
034 035 0005	81.90801.0224	178
034 035 0013	81.96601.0298	178
034 035 0029	81.43270.6040 81.43270.6045	162
034 035 0038	51.01510.0150	6
034 040 0002	81.45503.0049 81.45503.0056	185
034 041 9022	81.39108.6048 81.39374.6003	140
034 042 0001	90.91157.8013	129
034 042 0002	-	129
034 042 0003	90.91159.0013	129
034 042 0007	81.52116.6010 81.52116.6037	131
034 042 0017	81.50213.0013 81.50213.6005 81.50213.6006	113
034 042 0024	81.51270.6002	121
034 042 0029/C	81.50610.6132	114
034 042 0030	81.51113.0013	128
034 042 0032	81.52102.0008 82.52102.0013	117
034 042 0033	81.51220.6024	118
034 042 0034	81.51220.6025	118
034 042 0039	81.51220.6032 81.51220.6069	119



MEYLE no.	Ref. no.	Page
<b>MAN</b>		
	81.51220.6093 81.51220.6096	
034 042 0043	81.51113.0014 99.10036.0792	128
034 042 0048	81.52115.6009 81.52115.6017 81.52115.6018 81.52115.6021 90.81011.4192	119
034 042 0051	81.52120.6003 81.52120.6004 81.52120.6025 81.52120.6028 81.52120.6029 81.52120.6030 81.52120.6040 81.52120.6075 85.30001.6535 88.52120.6200	125
034 042 0053	81.50822.6022 81.50822.6032	93
034 042 0061	81.51113.0012	127
034 042 0062	81.51113.0020	128
034 043 0002	81.51113.0001	127
034 043 0005	81.15701.6003	122
034 043 0056	81.52101.6241 81.52101.6246 81.52101.6275	116
034 043 0066	81.52116.6074 81.52116.6075 81.52116.9075	132
034 043 0070	81.52116.6070	131
034 046 0000	81.47301.6005	186
034 321 0009	81.08304.0100	19
034 323 0003	81.11101.6013 81.11101.6151	27
034 600 6000	81.30300.6002 81.30300.6003	143
034 650 0000	06.32499.0020 06.32499.0082 06.32499.0084 06.32499.0085 06.32499.0157 87.52340.1240	175
034 650 0001	06.32490.3200 06.32499.0016	174

MEYLE no.	Ref. no.	Page
<b>MAN</b>		
	06.32499.0034 81.93420.0131 87.52340.0820	
034 650 0020	81.93420.0336 81.93420.0379 81.93420.6083 81.93420.6099	177
034 753 0017	81.96503.0155	183
034 753 0020	06.56289.0371	181
034 753 0021	06.56289.0361	135
036 020 0001	81.95301.0014 81.95301.0064 81.95301.6067 81.95301.6162 81.95301.6239 81.95301.6272 90.80415.3111	195
036 020 0002	81.95301.0013 81.95301.0074 81.95301.6068 81.95301.6163 81.95301.6273 90.80415.3107 90.80415.3113	196
036 020 0003	81.95301.6060 81.95301.6135 81.95301.6140 81.95301.6249 81.95301.6328 81.95301.6358	199
036 020 0004	81.95301.0016 81.95301.0084 81.95301.6048 81.95301.6049 81.95301.6053 81.95301.6061 81.95301.6090 81.95301.6112 81.95301.6126 81.95301.6143 81.95301.6149 81.95301.6154 81.95301.6156 81.95301.6194 81.95301.6224 81.95301.6234	193





MEYLE no.	Ref. no.	Page
<b>MAN</b>		
	81.95301.6242 81.95301.6274 81.95301.6278 81.95301.6308 81.95301.6312 81.95301.6350 81.95301.6352	
036 020 0004/HD	81.95301.0016 81.95301.0084 81.95301.6048 81.95301.6049 81.95301.6053 81.95301.6061 81.95301.6090 81.95301.6112 81.95301.6126 81.95301.6143 81.95301.6149 81.95301.6154 81.95301.6156 81.95301.6194 81.95301.6224 81.95301.6234 81.95301.6242 81.95301.6274 81.95301.6278 81.95301.6308 81.95301.6312 81.95301.6350	194
036 020 0005	81.95301.0015 81.95301.6030 81.95301.6043 81.95301.6091 81.95301.6120 81.95301.6125 81.95301.6152 81.95301.6155 81.95301.6167 81.95301.6179 81.95301.6237 81.95301.6275	196
036 020 0005/HD	81.95301.0015 81.95301.6030 81.95301.6043 81.95301.6091 81.95301.6120	197

MEYLE no.	Ref. no.	Page
<b>MAN</b>		
	81.95301.6125 81.95301.6152 81.95301.6155 81.95301.6167 81.95301.6179 81.95301.6237 81.95301.6275	
036 020 0008	81.95301.0079 81.95301.6139 81.95301.6222 81.95301.6315 81.95301.6329 81.95301.6359	193
036 020 0015	81.85301.0076 81.95301.0078 81.95301.6141 81.95301.6304	198
036 020 0016	81.95301.0077 81.95301.0388 81.95301.6134 81.95301.6142 81.95301.6303 81.95301.6321	198
036 026 0016	81.95301.0045 81.95301.6016 81.95301.6169 81.95301.6172 81.95301.6176 81.95301.6266 81.95301.6269	136
039 238 0001	81.06111.0018	66
050 004 0790	51.96820.0251	83
050 004 1295	51.96820.0205	81
050 004 1390	51.96820.0304 51.96820.0314 51.96820.0317	85
050 005 1482	51.96820.0271	84
050 005 1530	51.96820.0332	86
050 006 1180	N1.01100.1846	89
050 006 2200	88.96820.0001	88
050 008 0855	81.96820.0051	88
050 008 0880	51.96820.0238	81
050 008 1158	51.96820.0322	85
050 008 1275	51.96820.0243 51.96820.0257 51.96820.0280	82



MEYLE no.	Ref. no.	Page
<b>MAN</b>		
050 008 1376	51.96820.0239	82
050 008 1398	-	89
050 008 1635	51.96820.0272 51.96820.0344	86
050 008 1655	51.96820.0346	87
050 008 1908	N1.01100.1840	88
050 008 1915	51.96820.0273 51.96820.0335	84
050 008 1920	51.96820.0345	87
050 009 1725	51.96820.0308	84
050 010 1688	51.96820.0325	85
050 010 1980	51.96820.0248	82
050 012 1515	51.96820.0250	83
050 012 1630	81.96820.0047	87
052 010 0975	06.58043.0120 06.58072.1201 06.58073.1201 6.58043.0120 6.58043.2120 6.58072.1201	77
052 010 1075	06.58073.1241 6.58043.0124 6.58043.2124 6.58072.1241	77
052 010 1100	06.58047.0125 06.58073.1251 6580 430 125 6580 432 125 6580 470 125 6580 721 251	78
052 010 1250	06.58043.2131	76
052 010 1375	06.58073.1361 06.58073.1362	78
052 010 1380	06.58073.1361 06.58073.1362 6.58043.0136 6.58043.2136 6.58072.1361	78
052 010 1425	06.58072.1361 06.58072.1381 06.58073.1381 51.96820.0132	79
052 010 1500	06.58073.1412	79
052 013 1000	06.58043.0221 06.58072.2211 65.80430.221	77

MEYLE no.	Ref. no.	Page
<b>MAN</b>		
052 013 1050	06.58043.0223 06.58072.2231 6.58072.2231	75
052 013 1155	06.58073.2272	79
052 013 1450	06.58043.0239 06.58043.2239 06.58046.0239 06.58046.2239 06.58072.2391 06.58072.2392 06.58073.2391	76
052 013 1475	06.58042.2240 06.58045.0240 06.58072.2401 06.58072.2402 06.58073.2401 51.96820.0128	80
052 013 1500	06.58043.0241 06.58045.0241 06.58047.2241 06.58072.2412 06.58073.2411 6.58041.0241 6.58041.2241 6.58043.0241 6.58043.2241	80
052 013 1525	06.58042.0242 06.58043.0242 06.58043.2242 06.58047.2242 06.58072.2422 06.58073.2421 6.58041.0242 6.58043.0242 6.58043.2242 6.58072.2421	75
052 013 1550	06.58043.0243 06.58043.2243 06.58047.2243 06.58072.2431 06.58072.2432 06.58072.2433 06.58073.2431 51.96820.0143 51.96820.0153	81
052 013 1600	06.58043.2245	76



MEYLE no.	Ref. no.	Page
<b>MAN</b>		
	06.58072.2452 51.96820.3001 51.96820.6001 51.96820.6027	
114 323 0001	51.12503.0004 51.12503.0005 51.12503.0009 51.12503.0010 51.12503.0012 51.12503.0016 51.12503.0018 51.12503.0028 51.12503.0029 51.12503.0030	23
12-12 319 0000	81.61910.0011	206
12-12 319 0001	85.61950.0025	207
12-12 319 0003	81.61910.0018	206
12-12 319 0009	36.77910.0020 81.77910.0012 81.77910.0027 81.77972.0155 83.77910.0526	207
12-12 320 0008	81.61910.0019	206
12-14 013 0001	81.54124.6013 81.54124.6017	115
12-14 223 0001	81.06102.6110 81.06102.6112 81.06102.6205 81.06102.6209 81.06102.6222 81.06102.6227	63
12-14 223 0002	81.06111.0019 81.06111.0020	37
12-14 223 0003	81.06102.6117 81.06102.6206 81.06102.6208 81.06102.6221 81.06102.6226	65
12-14 223 0004	81.06102.6098 81.06102.6099 81.06102.6201 81.06102.6202 81.06102.6218	63
12-14 223 0005	81.06102.6109 81.06102.6204 81.06102.6219	64

MEYLE no.	Ref. no.	Page
<b>MAN</b>		
12-14 223 0006	81.06102.6089 81.06102.6100 81.06102.6203 81.06102.6220	65
12-14 234 0001	51.06601.7002 51.06601.7003 51.06601.7006 51.06601.7008 51.06630.0060 51.06630.0065 51.06630.0070	40
12-14 234 0002	51.06630.0062 51.06630.0066	40
12-14 234 0003	51.06500.6637 51.06500.7049 51.06500.9049	60
12-14 234 0004	51.06630.0096 51.06630.0129	44
12-14 234 0005	51.06630.0107 51.06630.0131	45
12-14 234 0006	51.06630.0106 51.06630.0130	44
12-14 234 0007	51.06630.0076 51.06630.0108 51.06630.0115	43
12-14 234 0008	51.06630.0055 51.06630.0061 51.06630.0068 51.06630.9068	41
12-14 234 0009	51.06630.0073 51.06630.0077	42
12-14 234 0010	51.06630.0050 51.06630.0067	41
12-14 234 0011	51.06630.0071	41
12-14 234 0012	51.06630.0093 51.06630.0112	43
12-14 234 0013	51.06600.7030 51.06600.9030	35
12-14 234 0014	51.06600.7017 51.06600.7026 51.06600.7031 51.06600.7033 51.06600.7036 51.06601.7019	34
12-14 234 0015	51.06601.7013 51.06630.0064	40



MEYLE no.	Ref. no.	Page
<b>MAN</b>		
	51.06630.0069 51.06630.0072	
12-14 234 0016	51.06601.7009	36
12-14 234 0017	51.06601.7010	36
12-14 234 0018	51.06601.7015	36
12-14 234 0019	51.06630.0047	39
12-14 234 0020	51.06630.0037 51.06630.0049 51.06630.0058 51.06630.9037	38
12-14 234 0021	51.06630.0031 51.06630.0042 51.06630.0043	38
12-14 234 0022	51.06630.0038	38
12-14 234 0023	51.06630.0007	37
12-14 234 0024	51.06630.0053	39
12-14 234 0025	51.06600.7008 51.06600.7015 51.06600.7045 51.06600.9045	35
12-14 234 0026	51.06630.0082	42
12-14 234 0027	51.06600.7006	34
12-14 234 0028	51.06630.0119 51.06630.0136 51.06630.0140	45
12-14 234 0029	51.06600.7025	34
12-14 234 0030	51.06630.0094 51.06630.0113 51.06630.0117	43
12-14 234 0031	51.06630.0124 51.06630.0127	44
12-14 322 0000	51.05504.0098 81.05504.0025	14
12-14 322 0001	51.05504.0096 82.05504.6096	14
12-14 322 0003	51.05501.7160 51.05501.7161 51.05501.7163 51.05501.7166 51.05501.7180	13
12-14 322 0004	51.05504.0107 51.05504.0108 51.05504.0122	15
12-14 323 0002	51.12503.0037 51.12503.0042 51.12503.0056	24

MEYLE no.	Ref. no.	Page
<b>MAN</b>		
	82.12503.0042	
12-14 650 0002	06.32499.0068 06.32499.0079 87.52330.0200	175
12-14 650 0005	06.32489.0003 06.32489.0044 81.93420.0078	174
12-14 650 0006	81.93420.0288 81.93420.0330 81.93420.0349	176
12-14 653 0000	81.96502.6081	182
12-14 653 0001	81.52403.6001	182
12-14 751 0006	81.93420.0320 81.93420.0342 81.93420.0376 81.93420.6097	176
12-14 751 0007	81.93420.0346	177
12-14 753 0000	06.56289.0257 06.56289.0261 06.56289.0272 06.56289.0307 06.56289.0308 06.56289.0309 06.56289.0386	180
12-14 753 0001	06.56279.0366	134
12-14 753 0002	06.56289.0047 06.56289.0048 06.56289.0357	180
12-14 753 0004	06.56289.0027 06.56289.0064 06.56289.0332 06.56289.0335 81.96501.0861 81.96506.0155	182
12-14 753 0005	81.96503.0161	183
12-14 753 0006	81.96503.0188 81.96503.0398	184
12-14 753 0007	06.56289.0387	181
12-14 753 0008	81.96503.0333 81.96503.0399	184
12-14 753 0009	81.96503.0339 81.96503.0445 81.96503.0530	184
12-14 753 0010	81.96503.6000	185
12-14 753 0013	06.56289.0279 06.56289.0280	134



MEYLE no.	Ref. no.	Page
<b>MAN</b>		
	06.56289.0293 81.96502.6052 81.96502.6066	
12-14 753 0014	06.56289.0319 81.35412.6003	135
12-14 820 0000	81.27421.0098 81.27421.0109	11
12-14 910 0001	81.61851.6019 81.61851.6023 81.61851.6029	208
12-14 910 0004	81.41723.6124 83.41723.6124	216
12-14 910 0005	81.41723.6123 83.41723.6123	215
12-14 910 0100	85.41723.6011 85.41723.6020	215
12-14 910 0102	81.41723.6059 81.41723.6103 81.41723.6114 81.41723.9114	215
12-28 279 0000	51.06402.0034 51.06402.0050 51.06402.0056 51.06402.0061 51.06402.0064 51.06402.0067	62
12-31 106 0001	81.30560.6019 81.30560.6022	143
12-31 106 0002	81.32411.0006 81.32411.0007	142
12-31 106 0003	81.30560.0070 81.30560.0075	142
12-31 106 0004	81.30530.0037	144
12-31 106 0005	81.30560.0067 81.30560.0068 81.30560.0078 81.30560.6023 81.30560.6024 81.32411.0009 81.93021.0424 N2.93021.0137	143
12-31 106 0006	81.95302.0079 81.95302.0080	144
12-31 106 6032	81.30550.0041 81.30550.0050 81.30550.6019	141

MEYLE no.	Ref. no.	Page
<b>MAN</b>		
12-33 220 0001	51.06500.7033 51.06500.7036 51.06500.7043 51.06500.7045 51.06500.7047 51.06500.7048 51.06500.7051 51.06500.7052 51.06500.7065 51.06500.7066 51.06500.9048 51.06500.9052 51.06500.9066 51.06500.9548	61
12-33 220 0003	51.06500.6616 51.06500.9616	58
12-33 500 0001	51.06500.6546 51.06500.9546	57
12-33 500 6408	51.06500.6408 51.06500.9408	55
12-33 500 6547	51.06500.6545 51.06500.6547 51.06500.9545 51.06500.9547	57
12-33 500 6548	51.06500.6548 51.06500.9548	58
12-34 000 1002	51.95800.7437 51.95800.7479	73
12-34 000 1003	51.95800.7428 51.95800.7429 51.95800.7436 51.95800.7459 51.95800.7477	73
12-34 000 1004	51.95800.6087	74
12-34 000 1100	51.95800.6076 51.95800.6092 51.95800.6099	75
12-34 000 1101	51.95800.6061 51.95800.6075	74
12-34 001 0001	81.43270.6065	162
12-34 001 0009	81.43220.6241	161
12-34 003 0001	51.27120.0005 51.27120.0008 51.27120.0011	9
12-34 003 0002	51.27120.0006 51.27120.0009	9



MEYLE no.	Ref. no.	Page
<b>MAN</b>		
	51.27120.0012	
12-34 003 0009	51.27120.0014	10
12-34 003 0010	51.27120.0015	10
12-34 003 0011	51.27120.0016 51.27120.7035 51.27120.7037 51.27120.7038	11
12-34 009 0003	51.12101.7045 51.12101.7046 51.12101.7120 51.12101.7128 51.12101.7137	22
12-34 020 0001	51.06601.0275	51
12-34 026 0000	81.32620.0049	202
12-34 026 0001	81.32620.0039 81.32620.0043 81.32620.0085	202
12-34 026 0002	81.52131.6015 81.52170.6139 81.52170.6151	130
12-34 026 0003	81.97010.6011	203
12-34 026 0004	81.97010.6010	202
12-34 029 0001	81.25503.0244	-
12-34 030 0000	81.96210.0525 81.96210.0553 81.96210.0574	32
12-34 030 0001	81.96210.6065 81.96210.6071 81.96210.6072	33
12-34 030 0002	81.96210.0572 81.96210.0592 81.96210.0597	33
12-34 030 0003	81.96210.0562 81.96210.0571 81.96210.0575 81.96210.0577	32
12-34 030 0004	81.41506.0096	29
12-34 030 0006	81.96020.0402	31
12-34 030 0007	81.96020.0341 81.96020.0373 81.96020.0408	30
12-34 030 0008	81.96210.0388 81.96210.0494 81.96210.0495	32
12-34 030 0009	64.96020.0003 81.96020.0205	29

MEYLE no.	Ref. no.	Page
<b>MAN</b>		
	81.96020.0235 81.96020.0382 88.96210.0004	
12-34 030 0011	81.96020.0202 81.96020.0239	30
12-34 030 0012	81.96020.0340 81.96020.0372	30
12-34 030 0013	81.96020.0391 81.96020.0403	31
12-34 032 0000	81.43610.6124 81.43610.6129	117
12-34 032 0002	81.96020.0231 81.96020.0250 81.96020.0252	150
12-34 032 0003	81.43722.0051 81.43722.0060	149
12-34 032 0007	81.25937.0010 81.25937.0015	117
12-34 035 0002	81.43220.6221 81.43270.6096 81.43270.6114	155
12-34 035 0003	81.43220.6229 81.43220.6236 81.43220.6267 81.43220.6272 81.43220.6304 81.43220.6305 81.43220.9236	159
12-34 035 0004	81.46610.6004 81.46610.6006 81.46610.6753 81.46610.6754 85.46610.6031 85.46610.6104 85.46610.6203	192
12-34 035 0005	81.43270.6116 81.43270.6137	156
12-34 035 0006	81.43270.6117	155
12-34 040 0001	51.00900.6531 51.00900.6604	4
12-34 042 0010	81.50822.6009	93
12-34 042 0012	81.50822.6020 81.50822.6031	93
12-34 042 0014	81.50802.6017 81.50802.6020 81.50802.6021	92



MEYLE no.	Ref. no.	Page
<b>MAN</b>		
12-34 042 0015	81.50802.6022	92
12-34 042 0017	81.50802.6025	92
12-34 042 0021	81.50822.6019 81.50822.6034 81.50822.6037	94
12-34 042 0026	81.52108.6001 81.52108.6025 81.52155.0040 81.52155.0041	116
12-34 043 0001	81.52116.6067 81.52116.6068 81.52116.6069	131
12-34 043 0002	81.52301.6148 81.52301.9148 82.58000.0060	126
12-34 050 0001	81.43270.6097 81.43270.6113 81.43270.6135	155
12-34 050 0002	81.43220.6268 81.43220.6291	152
12-34 050 0003	81.43220.6222 81.43220.6260 81.43220.6283 81.43220.6284	152
12-34 058 0001	81.41715.6013	213
12-34 058 0002	81.41715.6014	214
12-34 058 0003	81.41700.6095	213
12-34 058 0004	81.96210.0362 81.96210.0407	214
12-34 089 0001	81.90712.0844 81.90713.0909	209
12-34 099 0003	51.01510.0172 51.01510.0174 51.01510.0179 51.01510.0219 51.01510.0237 51.01510.7000	7
12-34 099 0004	51.01510.0133 51.01510.0134 51.01510.0140 51.01510.0141 51.01510.0184 51.01510.0196 51.01510.0206 51.01510.0207 51.01510.0208	6

MEYLE no.	Ref. no.	Page
<b>MAN</b>		
12-34 099 0005	51.01510.0151 51.01510.0218	7
12-34 099 0006	51.01510.0197 51.01510.0199 51.01510.0226 51.01510.6003 51.01510.6004 51.01510.6006 51.01510.6007	8
12-34 099 0007	51.01510.0236 51.01510.0273 51.01510.0282 51.01510.6005 51.01510.6008	8
12-34 100 6558	51.00900.6536 51.00900.6552 51.00900.6558	1
12-34 126 6017	81.39126.6017 81.39200.6015	141
12-34 126 6020	81.39126.6020 81.39126.6030 81.99917.8470	141
12-34 130 0032	51.02130.0005 51.02130.0007 51.02130.0008 51.02130.0012 51.02130.0032	5
12-34 151 0002	81.39410.6020	139
12-34 151 0003	81.39410.6023 81.39410.6031	140
12-34 152 0002	81.15210.0049	89
12-34 152 0003	81.15210.0054	90
12-34 152 0005	81.15210.0071	90
12-34 152 0007	81.15210.0056	90
12-34 152 0009	81.15210.0078	91
12-34 157 0003	81.15701.6112	122
12-34 157 0004	81.15701.6124	124
12-34 157 0005	81.15701.6113 81.15701.6120	123
12-34 157 0007	81.15701.6091 81.15701.6099 81.15701.6116 81.15701.6119	123
12-34 157 0008	81.15700.6006 81.15700.9006 81.15701.6079	122



MEYLE no.	Ref. no.	Page
<b>MAN</b>		
12-34 205 0001	81.44205.6023	148
12-34 205 6013	81.44205.6013	148
12-34 210 0348	81.96210.0340 81.96210.0348 81.96210.0349	208
12-34 210 0400	81.96210.0400	210
12-34 210 0401	81.96101.0638	209
12-34 210 0402	81.96503.0129	213
12-34 210 0403	81.96210.0369 81.96210.0462	208
12-34 210 0404	85.94299.0015	211
12-34 210 0405	85.96020.0004	211
12-34 210 0406	85.96210.0019	211
12-34 210 0408	85.96210.0021	212
12-34 210 0409	85.41715.0006	210
12-34 210 0437	81.96210.0424 81.96210.0437	210
12-34 210 0515	81.96210.0482 81.96210.0515	212
12-34 220 0004	51.06500.6587 51.06500.6651 51.06500.6680 51.06500.7070 51.06500.7079 51.06500.9079	60
12-34 220 6055	81.43220.6006 81.43220.6055 81.43220.6073 81.43220.6107	159
12-34 220 6108	81.43220.6108 81.43220.6132	160
12-34 223 0001	81.27421.0152 81.27421.0169	66
12-34 230 6051	81.43230.6051 81.43230.6068	161
12-34 232 0001	51.06601.0256	48
12-34 232 0002	51.06601.0257	49
12-34 232 0003	51.06601.0250	48
12-34 232 0004	51.06601.0172	46
12-34 232 0005	51.06601.0263	50
12-34 232 0006	51.06601.0268	51
12-34 232 0007	81.06601.0069	53
12-34 232 0008	51.06601.0234	48
12-34 232 0009	51.06601.0177 51.06601.0230	46
12-34 232 0010	51.06601.0198	47

MEYLE no.	Ref. no.	Page
<b>MAN</b>		
	51.06601.0199	
12-34 232 0011	51.06601.0102	46
12-34 232 0012	51.06601.0178	47
12-34 232 0013	51.06601.0265	50
12-34 232 0014	51.06601.0266	50
12-34 232 0015	51.06601.0258	49
12-34 232 0016	81.06601.0042	53
12-34 232 0017	51.06601.0233	47
12-34 232 0018	51.06601.0273 51.06601.0279	52
12-34 232 0019	51.06601.0283	52
12-34 232 0020	51.06601.0282	52
12-34 250 6135	81.46610.6809 81.46610.6810 81.46610.6823 81.46610.6839 81.46611.6104 81.46611.6105 81.46611.6107 81.46611.6134 81.46611.6135 81.46611.6137 81.46611.6199 81.46611.6200 81.46611.6206	191
12-34 250 6197	81.46610.6087 81.46610.6808 81.46610.6836 81.46610.6837 81.46611.6088 81.46611.6096 81.46611.6097 81.46611.6099 81.46611.6132 81.46611.6133 81.46611.6136 81.46611.6197 81.46611.6198 81.46611.6205	190
12-34 250 6244	81.43220.6244	161
12-34 250 6374/HD	81.46610.6019 81.46610.6374 82.46610.6080 82.46610.6189 82.46610.6190	189
12-34 250 6418	81.46710.6418	192





MEYLE no.	Ref. no.	Page
<b>MAN</b>		
12-34 250 6656	81.46610.6656	189
	81.46610.6659	
	81.46610.6669	
12-34 250 6767/HD	81.46610.6767	190
	81.46610.6768	
	81.46611.6014	
12-34 250 6860	81.46711.6773	188
	81.46711.6791	
	81.46711.6848	
	81.46711.6858	
	81.46711.6859	
	81.46711.6860	
	81.46711.6861	
	81.46711.6862	
	81.46711.6921	
12-34 255 0001	81.25509.0020	203
12-34 255 0002	81.25509.0028	204
	81.25509.0067	
	81.25509.0093	
	81.25509.0119	
12-34 255 0003	81.25509.0085	205
	81.25509.0118	
	81.25509.0123	
	81.25509.0127	
	81.25509.0128	
12-34 255 0009	81.25509.0125	204
12-34 255 0010	81.25509.0126	205
12-34 270 6079	81.43270.6079	163
	81.43270.6099	
12-34 271 0029	81.43271.0008	164
	81.43271.0029	
12-34 271 0040	81.43722.0040	167
	81.43722.0041	
	81.43722.0042	
12-34 271 0080	81.43271.0080	170
12-34 271 0081	81.43271.0081	164
12-34 271 0082	81.43271.0082	170
12-34 271 0083	81.43722.0072	173
12-34 271 0084	81.43704.0078	171
12-34 271 0085	81.43722.0059	172
12-34 271 0086	81.43722.0022	172
	81.43722.0038	
	81.96210.0450	

MEYLE no.	Ref. no.	Page
<b>MAN</b>		
	81.96210.0469	
12-34 271 0088	81.43722.0083	168
12-34 271 0089	85.43704.0002	169
12-34 271 0090	85.43704.0004	169
12-34 271 0091	85.43722.0007	170
12-34 271 0092	85.43704.0005	169
12-34 271 0094	81.43722.0053	167
	85.93020.0005	
12-34 271 0095	81.43704.0077	166
12-34 271 0096	81.43704.0074	171
12-34 271 0098	81.43722.0068	173
12-34 271 0100	81.96210.0294	168
12-34 271 0101	81.43722.0052	167
12-34 279 0073	06.56279.0027	134
	06.56279.0072	
	06.56279.0073	
	81.96501.0907	
12-34 301 6132	81.43270.6080	163
	81.95301.6132	
12-34 301 6133	81.43270.6083	163
	81.95301.6133	
12-34 321 0002	81.08304.0084	17
12-34 321 0003	81.08405.0016	21
	81.08405.0020	
	81.08405.0021	
12-34 321 0004	81.08304.0085	18
	81.08405.0012	
12-34 321 0005	81.08405.0017	20
12-34 321 0006	81.08304.0087	20
	81.08405.0015	
12-34 321 0008	81.08304.0046	19
	81.08405.0008	
12-34 321 0009	81.08405.0018	20
	81.08405.0018	
12-34 321 0010	81.08304.0038	16
	81.08304.0043	
	81.08304.0044	
	81.08304.0091	
	81.08401.6213	
12-34 321 0011	81.08304.0074	17
	81.08304.0076	
12-34 321 0014	81.08304.0093	18
12-34 321 0017	81.08405.0022	21
12-34 321 0018	81.08405.0023	21
12-34 321 0019	81.08304.0101	19
	81.08304.0103	
12-34 321 0021	81.08405.0029	22



MEYLE no.	Ref. no.	Page
<b>MAN</b>		
12-34 321 0022	81.08405.0030	22
12-34 323 0001	51.12503.0059 51.12503.0060	24
12-34 323 0003	81.12501.0021 81.12501.0026 81.12501.0030 81.12503.0033 81.12503.0086	28
12-34 323 0004	81.12501.0022 81.12501.0032 81.12501.0034 81.12503.0080 85.12501.0002	28
12-34 323 0005	81.12501.0031 81.12503.0085 82.12503.0069	28
12-34 323 0006	81.00000.0246 81.12503.0021 81.12503.0022 81.12503.0042 81.12503.0048 81.12503.0054 81.12503.0063	27
12-34 323 0007	51.12503.0061 51.12503.0063	25
12-34 323 0009	51.12503.0047 51.12503.0062	25
12-34 323 0012	51.12503.0048	24
12-34 410 0002	81.39410.6013 81.39410.6017 81.39410.6019	139
12-34 471 0001	81.47101.6000 81.47101.6001 81.47101.6031 81.47101.6040 81.47101.6051 81.47101.6169	199
12-34 471 0003	81.47101.6137 81.47101.6162 81.47101.6181 81.47101.9137 81.47101.9162	200
12-34 500 6495	51.06500.6495 51.06500.9495	56
12-34 500 6543	51.06500.6543 51.06500.9543	57

MEYLE no.	Ref. no.	Page
<b>MAN</b>		
12-34 500 6612	51.06500.6606 51.06500.6612 51.06500.6669 51.06500.9606 51.06500.9612 51.06500.9669	59
12-34 500 6642	51.06500.6642 51.06500.6675 51.06500.9642	59
12-34 500 6646	51.06500.6646 51.06500.6676 51.06500.7050 51.06500.9050 51.06500.9646	59
12-34 500 7064	51.06500.6679 51.06500.7064 51.06500.7078 51.06500.9064 51.06500.9078 51.06500.9679 51.06500.9699	61
12-34 527 0001	81.50822.6011 81.50822.6016	102
12-34 533 0100	81.27120.6156	105
12-34 533 0101	81.27120.6149	104
12-34 533 0102	81.27120.6157	105
12-34 533 0103	81.27120.0021	103
12-34 610 0001	81.43722.0044 81.43722.0061 83.43722.0001	149
12-34 631 0001	81.47101.6121 81.47101.6136 81.47101.6161	200
12-34 631 0002	81.47101.6102 81.47101.6108 81.47101.6189	200
12-34 632 0001	81.05504.6001 81.47307.0001 82.05504.6001	186
12-34 632 0002	81.47301.6048	201
12-34 704 0029	81.43704.0029	171
12-34 704 0057	81.43704.0057	165
12-34 704 0060	81.43704.0060	165
12-34 704 0061	81.43704.0061	165
12-34 722 0019	81.43722.0019 81.43722.6051	166



MEYLE no.	Ref. no.	Page
<b>MAN</b>		
12-34 722 0021	81.43722.0021	173
	81.43722.0039	
	81.43722.0063	
	81.43722.0081	
	81.43722.0082	
12-34 722 0062	81.43722.0062	150
12-34 725 6025	81.30725.6007	145
	81.30725.6024	
	81.30725.6025	
	81.30725.6026	
	81.30725.9025	
12-34 725 6027	81.30725.6027	145
	81.30725.6028	
	81.30725.6045	
	81.30725.6046	
12-34 725 6032	81.30725.6031	145
	81.30725.6032	
	81.30725.6053	
	81.30725.6054	
12-34 742 0000	81.96210.0554	150
12-34 742 0001	81.96210.0555	151
12-34 742 0005	81.96210.5025	151
	81.96210.5026	
	81.96210.5027	
12-34 742 0006	81.96210.5022	151
12-34 751 0001	81.93420.0336	177
12-34 753 0000	06.56279.0033	180
	06.56289.0065	
	06.56289.0330	
	06.56289.0331	
	06.56289.0333	
	06.56289.0334	
	81.96503.0154	
12-34 798 0001	81.44205.6025	149
12-34 830 0005	81.25902.0460	225
	81.25902.0474	
12-34 830 0006	81.25902.0155	225
	81.25902.0274	
12-34 830 0101	81.25260.6105	216
12-34 870 0001	81.26485.6032	222
	81.26485.6033	
12-34 870 0002	81.26485.6027	221
	81.26485.6030	
12-34 870 0004	81.26485.6008	221
12-34 899 0002	81.46433.6006	220
	81.46433.6011	

MEYLE no.	Ref. no.	Page
<b>MAN</b>		
	81.97100.6034	
	81.97100.6095	
12-34 899 0004	51.27421.0198	12
	51.27421.0216	
12-34 899 0005	81.27120.6119	110
	81.27120.6182	
12-34 899 0006	81.27120.6183	110
12-34 899 0007	81.27120.6179	109
12-34 899 0008	81.27120.6178	109
12-34 899 0009	81.27120.6205	112
12-34 899 0010	81.27120.6206	113
12-34 899 0011	81.27120.6125	107
	81.27120.6169	
12-34 899 0012	81.27120.6126	107
	81.27120.6168	
12-34 899 0013	81.27120.6137	106
	81.27120.6165	
12-34 899 0014	81.27120.6110	106
	81.27120.6138	
	81.27120.6164	
12-34 899 0015	81.27120.6105	103
12-34 899 0016	81.27120.6106	104
12-34 899 0017	81.27120.6121	111
	81.27120.6184	
12-34 899 0018	81.24120.6122	111
	81.27120.6185	
	81.51101.6485	
12-34 899 0019	81.27120.6187	112
12-34 899 0020	81.27120.6176	108
12-34 899 0021	81.27120.6177	108
12-34 899 0022	51.27421.0077	12
12-34 899 0023	81.25525.0033	-
	81.25525.0227	
	81.25525.0257	
12-34 900 0000	51.00900.6630	2
12-34 900 0001	51.00900.6629	2
	51.00900.6639	
12-34 900 0002	51.00900.6628	2
	51.00900.6650	
12-34 900 6437	51.00900.6273	1
	51.00900.6437	
	51.00900.6570	
12-34 904 0132	51.05904.0132	12
12-34 905 0001	51.03905.0157	3
12-34 905 0002	51.03905.0161	4
12-34 905 0135	51.03905.0091	3



MEYLE no.	Ref. no.	Page
<b>MAN</b>		
	51.03905.0094	
	51.03905.0098	
	51.03905.0103	
	51.03905.0104	
	51.03905.0105	
	51.03905.0109	
	51.03905.0123	
	51.03905.0134	
	51.03905.0135	
12-34 910 0001	81.62641.6085	218
12-34 910 0002	81.62641.6086	218
12-34 910 0003	81.97100.6079 81.97100.6099	218
12-34 910 0005	81.62641.0099	217
12-34 910 0006	81.62641.0100	217
12-34 910 0008	81.62680.6096	219
12-34 910 0009	81.62680.6095	219
12-34 910 0010	81.62640.6045 81.62640.6049 81.62640.6055	220
12-34 910 0011	81.62640.6046 81.62640.6050 81.62640.6056	221
12-34 920 1002	81.74821.0109	216
12-35 521 0000	81.50803.0010	94
12-35 521 0002	81.50803.0023 81.50803.0031 81.50803.0033 81.50803.0034 81.50803.0035 81.50803.0036 81.50803.0038 81.50803.0040 81.50803.0046	95
12-35 521 0003	81.50803.0028 81.50803.0048	97
12-35 521 0004	81.50803.0021 81.50803.0041	96
12-35 521 0005	81.50803.0020 81.50803.0027 81.50803.0057	97
12-35 521 0007	81.50803.0024 81.50803.0026	94
12-35 521 0008	81.50803.0039	95
12-35 521 0012	81.50803.0044	96
12-35 523 0000	81.50803.0022	98

MEYLE no.	Ref. no.	Page
<b>MAN</b>		
	81.50803.0061	
12-35 523 0005	81.50803.0043 81.50803.0062	98
12-35 533 0000	81.52101.6153 81.52101.6154	120
12-35 533 0001	81.52101.6269	120
12-35 533 0002	81.52101.6270	121
12-35 533 0003	81.52110.6049 81.52110.6095	119
12-35 533 0004	81.52116.6071	132
12-35 533 0005	81.52151.6093 81.52151.6096	124
12-35 533 0007	81.52301.6183 81.52301.6189 81.52301.6192	125
12-35 533 0031	81.52315.6156 81.52315.6160 81.52315.6161	127
12-35 533 0034	81.52151.6094	124
12-35 533 0037	81.52301.6120 81.52301.6121 81.52310.6165	126
12-36 020 0032	81.95301.6263	194
12-36 020 0039	81.95301.6270	195
12-36 020 0041	81.95301.6288	197
12-36 030 0002	81.46710.6112 81.46710.6163 81.46710.6165 81.46710.6198 81.46710.6353 81.46710.6354 81.46710.6361 81.46711.6725 81.46711.6820 81.46711.6849	187
12-36 030 0002/HD	81.46710.6112 81.46710.6163 81.46710.6165 81.46710.6198 81.46710.6353 81.46710.6354 81.46711.6725 81.46711.6820 81.46711.6849	188
12-36 030 0004	81.43220.6030 81.43220.6096	157



MEYLE no.	Ref. no.	Page
<b>MAN</b>		
	81.43220.6097 81.43220.6098 81.43220.6129 81.43230.6014	
12-36 030 0011/HD	81.46610.6689 81.46610.6720 81.46711.6721	187
12-36 030 0013	81.43220.6247	152
12-36 030 0016	36.43220.6002 36.43220.6043 81.43220.6139 81.43220.6151 81.43220.6183 81.43220.6276 81.43220.6277	153
12-36 035 0002	81.43220.6067 81.43220.6068 81.43220.6090 81.43220.6092 81.43220.6120 81.43220.9092	156
12-36 035 0003	81.43220.6070 81.43220.6071 81.43220.6072 81.43220.6091 81.43220.6093 81.43220.6119	157
12-36 035 6087	81.43270.6087 81.43270.6088 81.43270.6094 81.43270.6095	154
12-36 035 6196	81.43220.6196 81.43220.6232 81.43220.6233	158
12-36 040 0009	81.46610.6333 81.46610.6334 81.46610.6354 81.46610.6355 81.46610.6360 81.46610.6361 81.46610.6721 81.46610.6722 81.46610.6723 81.46611.6216	191
12-36 050 0000	81.43270.6030 81.43270.6034	154

MEYLE no.	Ref. no.	Page
<b>MAN</b>		
	81.43270.6054 81.43270.6057 81.43270.6076 81.43270.6078 81.43270.6082 81.43270.9054 81.43270.9078	
12-36 050 0001	81.43270.6056 81.43270.6067 81.43270.6075 81.43270.6077 81.43270.6081	153
12-36 050 0002	81.43220.6161 81.43220.6190	158
12-37 142 0001	81.30715.6111 81.30715.6119 81.30715.6121	147
12-37 142 0002	81.30715.6108 81.30715.6120	147
12-37 142 0003	81.30725.6065 81.30725.6086	146
12-37 142 0004	81.30725.6084 81.30725.6085 81.30725.6092 81.30725.6107 81.30725.6116	146
12-37 142 0007	81.52170.6096 81.52170.6156	133
12-39 222 0001	81.96301.0496 81.96301.0659 82.96301.0008	68
12-39 222 0003	81.96305.0088	70
12-39 222 0004	81.96305.0129	71
12-39 222 0005	81.96301.0677	68
12-39 222 0006	81.96301.0898 82.96301.0006	70
12-39 222 0007	81.96301.0893	70
12-39 222 0008	81.96301.0892	69
12-39 222 0009	81.96305.0227	72
12-39 222 0011	81.96305.0230	73
12-39 222 0013	51.96305.0018 51.96305.0021 81.96305.0095 81.96305.0134 81.96305.0223 81.96305.0226	71



MEYLE no.	Ref. no.	Page
<b>MAN</b>		
12-39 222 0014	81.96301.0581 81.96301.0676	67
12-39 222 0015	81.96301.0582 81.96301.0621	68
12-39 222 0016	81.96305.0166	71
12-39 222 0017	81.96301.0680	69
12-39 222 0018	81.96301.0679	69
12-39 222 0019	04.27405.9502 04.27405.9510	67
12-39 222 0020	81.96305.0130 81.96305.0169	72
12-39 222 0026	04.27405.0601 04.27405.9160 04.27405.9360 N1.01100.8494	66
14-34 043 0001	85.30001.9636 85.32734.6001	138
14-34 232 0012	81.06601.0072	54
14-36 035 0003	81.43220.6203	160
16-34 321 0010	81.08304.0051	16
16-34 653 0001	81.43220.6197 81.95302.0038 81.95302.0057	160
300 334 1103	51.93410.0079	175
812 321 0001	81.08304.0086	18
834 533 0004	81.25937.0016	118





Ref. no.	MEYLE no.	Page
<b>MAN</b>		
04.27405.0601	12-39 222 0026	66
04.27405.9160	12-39 222 0026	66
04.27405.9360	12-39 222 0026	66
04.27405.9502	12-39 222 0019	67
04.27405.9510	12-39 222 0019	67
06.32489.0003	12-14 650 0005	174
06.32489.0044	12-14 650 0005	174
06.32490.3200	034 650 0001	174
06.32499.0016	034 650 0001	174
06.32499.0020	034 650 0000	175
06.32499.0034	034 650 0001	174
06.32499.0068	12-14 650 0002	175
06.32499.0079	12-14 650 0002	175
06.32499.0082	034 650 0000	175
06.32499.0084	034 650 0000	175
06.32499.0085	034 650 0000	175
06.32499.0157	034 650 0000	175
06.56279.0027	12-34 279 0073	134
06.56279.0033	12-34 753 0000	180
06.56279.0072	12-34 279 0073	134
06.56279.0073	12-34 279 0073	134
06.56279.0366	12-14 753 0001	134
06.56289.0027	12-14 753 0004	182
06.56289.0047	12-14 753 0002	180
06.56289.0048	12-14 753 0002	180
06.56289.0064	12-14 753 0004	182
06.56289.0065	12-34 753 0000	180
06.56289.0257	12-14 753 0000	180
06.56289.0261	12-14 753 0000	180
06.56289.0272	12-14 753 0000	180
06.56289.0279	12-14 753 0013	134
06.56289.0280	12-14 753 0013	134
06.56289.0293	12-14 753 0013	134
06.56289.0307	12-14 753 0000	180
06.56289.0308	12-14 753 0000	180
06.56289.0309	12-14 753 0000	180
06.56289.0319	12-14 753 0014	135
06.56289.0330	12-34 753 0000	180
06.56289.0331	12-34 753 0000	180
06.56289.0332	12-14 753 0004	182
06.56289.0333	12-34 753 0000	180
06.56289.0334	12-34 753 0000	180
06.56289.0335	12-14 753 0004	182
06.56289.0357	12-14 753 0002	180
06.56289.0361	034 753 0021	135
06.56289.0371	034 753 0020	181

Ref. no.	MEYLE no.	Page
<b>MAN</b>		
06.56289.0386	12-14 753 0000	180
06.56289.0387	12-14 753 0007	181
06.58042.0242	052 013 1525	75
06.58042.2240	052 013 1475	80
06.58043.0120	052 010 0975	77
06.58043.0221	052 013 1000	77
06.58043.0223	052 013 1050	75
06.58043.0239	052 013 1450	76
06.58043.0241	052 013 1500	80
06.58043.0242	052 013 1525	75
06.58043.0243	052 013 1550	81
06.58043.2131	052 010 1250	76
06.58043.2239	052 013 1450	76
06.58043.2242	052 013 1525	75
06.58043.2243	052 013 1550	81
06.58043.2245	052 013 1600	76
06.58045.0240	052 013 1475	80
06.58045.0241	052 013 1500	80
06.58046.0239	052 013 1450	76
06.58046.2239	052 013 1450	76
06.58047.0125	052 010 1100	78
06.58047.2241	052 013 1500	80
06.58047.2242	052 013 1525	75
06.58047.2243	052 013 1550	81
06.58072.1201	052 010 0975	77
06.58072.1361	052 010 1425	79
06.58072.1381	052 010 1425	79
06.58072.2211	052 013 1000	77
06.58072.2231	052 013 1050	75
06.58072.2391	052 013 1450	76
06.58072.2392	052 013 1450	76
06.58072.2401	052 013 1475	80
06.58072.2402	052 013 1475	80
06.58072.2412	052 013 1500	80
06.58072.2422	052 013 1525	75
06.58072.2431	052 013 1550	81
06.58072.2432	052 013 1550	81
06.58072.2433	052 013 1550	81
06.58072.2452	052 013 1600	76
06.58073.1201	052 010 0975	77
06.58073.1241	052 010 1075	77
06.58073.1251	052 010 1100	78
06.58073.1361	052 010 1375	78
	052 010 1380	
06.58073.1362	052 010 1375	78
	052 010 1380	



Ref. no.	MEYLE no.	Page
<b>MAN</b>		
06.58073.1381	052 010 1425	79
06.58073.1412	052 010 1500	79
06.58073.2272	052 013 1155	79
06.58073.2391	052 013 1450	76
06.58073.2401	052 013 1475	80
06.58073.2411	052 013 1500	80
06.58073.2421	052 013 1525	75
06.58073.2431	052 013 1550	81
36.43220.6002	12-36 030 0016	153
36.43220.6043	12-36 030 0016	153
36.77910.0020	12-12 319 0009	207
51.00900.6273	12-34 900 6437	1
51.00900.6437	12-34 900 6437	1
51.00900.6531	12-34 040 0001	4
51.00900.6536	12-34 100 6558	1
51.00900.6552	12-34 100 6558	1
51.00900.6558	12-34 100 6558	1
51.00900.6570	12-34 900 6437	1
51.00900.6604	12-34 040 0001	4
51.00900.6628	12-34 900 0002	2
51.00900.6629	12-34 900 0001	2
51.00900.6630	12-34 900 0000	2
51.00900.6639	12-34 900 0001	2
51.00900.6650	12-34 900 0002	2
51.01510.0133	12-34 099 0004	6
51.01510.0134	12-34 099 0004	6
51.01510.0140	12-34 099 0004	6
51.01510.0141	12-34 099 0004	6
51.01510.0150	034 035 0038	6
51.01510.0151	12-34 099 0005	7
51.01510.0172	12-34 099 0003	7
51.01510.0174	12-34 099 0003	7
51.01510.0179	12-34 099 0003	7
51.01510.0184	12-34 099 0004	6
51.01510.0196	12-34 099 0004	6
51.01510.0197	12-34 099 0006	8
51.01510.0199	12-34 099 0006	8
51.01510.0206	12-34 099 0004	6
51.01510.0207	12-34 099 0004	6
51.01510.0208	12-34 099 0004	6
51.01510.0218	12-34 099 0005	7
51.01510.0219	12-34 099 0003	7
51.01510.0226	12-34 099 0006	8
51.01510.0236	12-34 099 0007	8
51.01510.0237	12-34 099 0003	7
51.01510.0273	12-34 099 0007	8

Ref. no.	MEYLE no.	Page
<b>MAN</b>		
51.01510.0282	12-34 099 0007	8
51.01510.6003	12-34 099 0006	8
51.01510.6004	12-34 099 0006	8
51.01510.6005	12-34 099 0007	8
51.01510.6006	12-34 099 0006	8
51.01510.6007	12-34 099 0006	8
51.01510.6008	12-34 099 0007	8
51.01510.7000	12-34 099 0003	7
51.02130.0005	12-34 130 0032	5
51.02130.0007	12-34 130 0032	5
51.02130.0008	12-34 130 0032	5
51.02130.0012	12-34 130 0032	5
51.02130.0013	034 003 1024	6
51.02130.0032	12-34 130 0032	5
51.03905.0091	12-34 905 0135	3
51.03905.0094	12-34 905 0135	3
51.03905.0098	12-34 905 0135	3
51.03905.0103	12-34 905 0135	3
51.03905.0104	12-34 905 0135	3
51.03905.0105	12-34 905 0135	3
51.03905.0109	12-34 905 0135	3
51.03905.0123	12-34 905 0135	3
51.03905.0134	12-34 905 0135	3
51.03905.0135	12-34 905 0135	3
51.03905.0157	12-34 905 0001	3
51.03905.0161	12-34 905 0002	4
51.04201.6111	034 005 1004	5
51.04202.5034	034 005 1015	4
51.05500.6073	014 018 0015	13
51.05501.7160	12-14 322 0003	13
51.05501.7161	12-14 322 0003	13
51.05501.7163	12-14 322 0003	13
51.05501.7166	12-14 322 0003	13
51.05501.7180	12-14 322 0003	13
51.05504.0048	014 018 0009	14
51.05504.0049	014 018 0009	14
51.05504.0068	014 018 0009	14
51.05504.0084	014 018 0009	14
51.05504.0085	014 018 0009	14
51.05504.0086	014 018 0009	14
51.05504.0091	014 018 0009	14
51.05504.0096	12-14 322 0001	14
51.05504.0098	12-14 322 0000	14
51.05504.0105	014 018 0015	13
51.05504.0107	12-14 322 0004	15
51.05504.0108	12-14 322 0004	15





Ref. no.	MEYLE no.	Page
<b>MAN</b>		
51.05504.0122	12-14 322 0004	15
51.05601.0148	034 018 1002	15
51.05904.0132	12-34 904 0132	12
51.06402.0034	12-28 279 0000	62
51.06402.0050	12-28 279 0000	62
51.06402.0056	12-28 279 0000	62
51.06402.0058	028 283 0000	61
51.06402.0060	028 283 0000	61
51.06402.0061	12-28 279 0000	62
51.06402.0063	028 283 0000	61
51.06402.0064	12-28 279 0000	62
51.06402.0066	028 283 0000	61
51.06402.0067	12-28 279 0000	62
51.06500.6282	033 020 0022	54
51.06500.6384	033 020 0022	54
51.06500.6387	033 020 0022	54
51.06500.6408	12-33 500 6408	55
51.06500.6426	033 020 0043	55
51.06500.6479	033 020 0048	56
51.06500.6495	12-34 500 6495	56
51.06500.6543	12-34 500 6543	57
51.06500.6545	12-33 500 6547	57
51.06500.6546	12-33 500 0001	57
51.06500.6547	12-33 500 6547	57
51.06500.6548	12-33 500 6548	58
51.06500.6587	12-34 220 0004	60
51.06500.6606	12-34 500 6612	59
51.06500.6612	12-34 500 6612	59
51.06500.6616	12-33 220 0003	58
51.06500.6637	12-14 234 0003	60
51.06500.6642	12-34 500 6642	59
51.06500.6646	12-34 500 6646	59
51.06500.6651	12-34 220 0004	60
51.06500.6669	12-34 500 6612	59
51.06500.6675	12-34 500 6642	59
51.06500.6676	12-34 500 6646	59
51.06500.6679	12-34 500 7064	61
51.06500.6680	12-34 220 0004	60
51.06500.7033	12-33 220 0001	61
51.06500.7036	12-33 220 0001	61
51.06500.7043	12-33 220 0001	61
51.06500.7045	12-33 220 0001	61
51.06500.7047	12-33 220 0001	61
51.06500.7048	12-33 220 0001	61
51.06500.7049	12-14 234 0003	60
51.06500.7050	12-34 500 6646	59

Ref. no.	MEYLE no.	Page
<b>MAN</b>		
51.06500.7051	12-33 220 0001	61
51.06500.7052	12-33 220 0001	61
51.06500.7064	12-34 500 7064	61
51.06500.7065	12-33 220 0001	61
51.06500.7066	12-33 220 0001	61
51.06500.7070	12-34 220 0004	60
51.06500.7078	12-34 500 7064	61
51.06500.7079	12-34 220 0004	60
51.06500.9048	12-33 220 0001	61
51.06500.9049	12-14 234 0003	60
51.06500.9050	12-34 500 6646	59
51.06500.9052	12-33 220 0001	61
51.06500.9064	12-34 500 7064	61
51.06500.9066	12-33 220 0001	61
51.06500.9078	12-34 500 7064	61
51.06500.9079	12-34 220 0004	60
51.06500.9282	033 020 0022	54
51.06500.9408	12-33 500 6408	55
51.06500.9479	033 020 0048	56
51.06500.9495	12-34 500 6495	56
51.06500.9543	12-34 500 6543	57
51.06500.9545	12-33 500 6547	57
51.06500.9546	12-33 500 0001	57
51.06500.9547	12-33 500 6547	57
51.06500.9548	12-33 220 0001 12-33 500 6548	58, 61
51.06500.9606	12-34 500 6612	59
51.06500.9612	12-34 500 6612	59
51.06500.9616	12-33 220 0003	58
51.06500.9642	12-34 500 6642	59
51.06500.9646	12-34 500 6646	59
51.06500.9669	12-34 500 6612	59
51.06500.9679	12-34 500 7064	61
51.06500.9699	12-34 500 7064	61
51.06600.7006	12-14 234 0027	34
51.06600.7008	12-14 234 0025	35
51.06600.7015	12-14 234 0025	35
51.06600.7017	12-14 234 0014	34
51.06600.7025	12-14 234 0029	34
51.06600.7026	12-14 234 0014	34
51.06600.7030	12-14 234 0013	35
51.06600.7031	12-14 234 0014	34
51.06600.7033	12-14 234 0014	34
51.06600.7036	12-14 234 0014	34
51.06600.7045	12-14 234 0025	35
51.06600.9030	12-14 234 0013	35



Ref. no.	MEYLE no.	Page
<b>MAN</b>		
51.06600.9045	12-14 234 0025	35
51.06601.0102	12-34 232 0011	46
51.06601.0172	12-34 232 0004	46
51.06601.0177	12-34 232 0009	46
51.06601.0178	12-34 232 0012	47
51.06601.0198	12-34 232 0010	47
51.06601.0199	12-34 232 0010	47
51.06601.0230	12-34 232 0009	46
51.06601.0233	12-34 232 0017	47
51.06601.0234	12-34 232 0008	48
51.06601.0250	12-34 232 0003	48
51.06601.0256	12-34 232 0001	48
51.06601.0257	12-34 232 0002	49
51.06601.0258	12-34 232 0015	49
51.06601.0263	12-34 232 0005	50
51.06601.0265	12-34 232 0013	50
51.06601.0266	12-34 232 0014	50
51.06601.0268	12-34 232 0006	51
51.06601.0273	12-34 232 0018	52
51.06601.0275	12-34 020 0001	51
51.06601.0279	12-34 232 0018	52
51.06601.0282	12-34 232 0020	52
51.06601.0283	12-34 232 0019	52
51.06601.7002	12-14 234 0001	40
51.06601.7003	12-14 234 0001	40
51.06601.7006	12-14 234 0001	40
51.06601.7008	12-14 234 0001	40
51.06601.7009	12-14 234 0016	36
51.06601.7010	12-14 234 0017	36
51.06601.7013	12-14 234 0015	40
51.06601.7015	12-14 234 0018	36
51.06601.7019	12-14 234 0014	34
51.06630.0007	12-14 234 0023	37
51.06630.0031	12-14 234 0021	38
51.06630.0037	12-14 234 0020	38
51.06630.0038	12-14 234 0022	38
51.06630.0042	12-14 234 0021	38
51.06630.0043	12-14 234 0021	38
51.06630.0047	12-14 234 0019	39
51.06630.0049	12-14 234 0020	38
51.06630.0050	12-14 234 0010	41
51.06630.0053	12-14 234 0024	39
51.06630.0055	12-14 234 0008	41
51.06630.0058	12-14 234 0020	38
51.06630.0060	12-14 234 0001	40
51.06630.0061	12-14 234 0008	41

Ref. no.	MEYLE no.	Page
<b>MAN</b>		
51.06630.0062	12-14 234 0002	40
51.06630.0064	12-14 234 0015	40
51.06630.0065	12-14 234 0001	40
51.06630.0066	12-14 234 0002	40
51.06630.0067	12-14 234 0010	41
51.06630.0068	12-14 234 0008	41
51.06630.0069	12-14 234 0015	40
51.06630.0070	12-14 234 0001	40
51.06630.0071	12-14 234 0011	41
51.06630.0072	12-14 234 0015	40
51.06630.0073	12-14 234 0009	42
51.06630.0076	12-14 234 0007	43
51.06630.0077	12-14 234 0009	42
51.06630.0082	12-14 234 0026	42
51.06630.0093	12-14 234 0012	43
51.06630.0094	12-14 234 0030	43
51.06630.0096	12-14 234 0004	44
51.06630.0106	12-14 234 0006	44
51.06630.0107	12-14 234 0005	45
51.06630.0108	12-14 234 0007	43
51.06630.0112	12-14 234 0012	43
51.06630.0113	12-14 234 0030	43
51.06630.0115	12-14 234 0007	43
51.06630.0117	12-14 234 0030	43
51.06630.0119	12-14 234 0028	45
51.06630.0124	12-14 234 0031	44
51.06630.0127	12-14 234 0031	44
51.06630.0129	12-14 234 0004	44
51.06630.0130	12-14 234 0006	44
51.06630.0131	12-14 234 0005	45
51.06630.0136	12-14 234 0028	45
51.06630.0140	12-14 234 0028	45
51.06630.9037	12-14 234 0020	38
51.06630.9068	12-14 234 0008	41
51.12101.7045	12-34 009 0003	22
51.12101.7046	12-34 009 0003	22
51.12101.7120	12-34 009 0003	22
51.12101.7128	12-34 009 0003	22
51.12101.7137	12-34 009 0003	22
51.12150.7003	034 009 0015	23
51.12150.7005	034 009 0015	23
51.12503.0004	114 323 0001	23
51.12503.0005	114 323 0001	23
51.12503.0009	114 323 0001	23
51.12503.0010	114 323 0001	23
51.12503.0012	114 323 0001	23



Ref. no.	MEYLE no.	Page
<b>MAN</b>		
51.12503.0016	114 323 0001	23
51.12503.0018	114 323 0001	23
51.12503.0028	114 323 0001	23
51.12503.0029	114 323 0001	23
51.12503.0030	114 323 0001	23
51.12503.0037	12-14 323 0002	24
51.12503.0042	12-14 323 0002	24
51.12503.0047	12-34 323 0009	25
51.12503.0048	12-34 323 0012	24
51.12503.0051	014 323 0008	26
51.12503.0056	12-14 323 0002	24
51.12503.0059	12-34 323 0001	24
51.12503.0060	12-34 323 0001	24
51.12503.0061	12-34 323 0007	25
51.12503.0062	12-34 323 0009	25
51.12503.0063	12-34 323 0007	25
51.12503.6000	014 323 0008	26
51.27120.0005	12-34 003 0001	9
51.27120.0006	12-34 003 0002	9
51.27120.0008	12-34 003 0001	9
51.27120.0009	12-34 003 0002	9
51.27120.0011	12-34 003 0001	9
51.27120.0012	12-34 003 0002	9
51.27120.0014	12-34 003 0009	10
51.27120.0015	12-34 003 0010	10
51.27120.0016	12-34 003 0011	11
51.27120.7035	12-34 003 0011	11
51.27120.7037	12-34 003 0011	11
51.27120.7038	12-34 003 0011	11
51.27421.0077	12-34 899 0022	12
51.27421.0198	12-34 899 0004	12
51.27421.0216	12-34 899 0004	12
51.54105.6006	034 013 0001	115
51.54114.6023	034 013 0006	114
51.54114.6024	034 013 0006	114
51.54114.6035	034 013 0006	114
51.54114.6045	034 013 0006	114
51.54114.6047	034 013 0006	114
51.54114.6049	034 013 0006	114
51.54114.6054	034 013 0006	114
51.93020.0236	034 003 1024	6
51.93410.0079	300 334 1103	175
51.95800.6061	12-34 000 1101	74
51.95800.6075	12-34 000 1101	74
51.95800.6076	12-34 000 1100	75
51.95800.6087	12-34 000 1004	74

Ref. no.	MEYLE no.	Page
<b>MAN</b>		
51.95800.6092	12-34 000 1100	75
51.95800.6099	12-34 000 1100	75
51.95800.7428	12-34 000 1003	73
51.95800.7429	12-34 000 1003	73
51.95800.7436	12-34 000 1003	73
51.95800.7437	12-34 000 1002	73
51.95800.7459	12-34 000 1003	73
51.95800.7477	12-34 000 1003	73
51.95800.7479	12-34 000 1002	73
51.96305.0018	12-39 222 0013	71
51.96305.0021	12-39 222 0013	71
51.96820.0128	052 013 1475	80
51.96820.0132	052 010 1425	79
51.96820.0143	052 013 1550	81
51.96820.0153	052 013 1550	81
51.96820.0205	050 004 1295	81
51.96820.0238	050 008 0880	81
51.96820.0239	050 008 1376	82
51.96820.0243	050 008 1275	82
51.96820.0248	050 010 1980	82
51.96820.0250	050 012 1515	83
51.96820.0251	050 004 0790	83
51.96820.0257	050 008 1275	82
51.96820.0271	050 005 1482	84
51.96820.0272	050 008 1635	86
51.96820.0273	050 008 1915	84
51.96820.0280	050 008 1275	82
51.96820.0304	050 004 1390	85
51.96820.0308	050 009 1725	84
51.96820.0314	050 004 1390	85
51.96820.0317	050 004 1390	85
51.96820.0322	050 008 1158	85
51.96820.0325	050 010 1688	85
51.96820.0332	050 005 1530	86
51.96820.0335	050 008 1915	84
51.96820.0344	050 008 1635	86
51.96820.0345	050 008 1920	87
51.96820.0346	050 008 1655	87
51.96820.3001	052 013 1600	76
51.96820.6001	052 013 1600	76
51.96820.6027	052 013 1600	76
64.96020.0003	12-34 030 0009	29
6.58041.0241	052 013 1500	80
6.58041.0242	052 013 1525	75
6.58041.2241	052 013 1500	80
6.58043.0120	052 010 0975	77



Ref. no.	MEYLE no.	Page
<b>MAN</b>		
6.58043.0124	052 010 1075	77
6580 430 125	052 010 1100	78
6.58043.0136	052 010 1380	78
65.80430.221	052 013 1000	77
6.58043.0241	052 013 1500	80
6.58043.0242	052 013 1525	75
6.58043.2120	052 010 0975	77
6.58043.2124	052 010 1075	77
6580 432 125	052 010 1100	78
6.58043.2136	052 010 1380	78
6.58043.2241	052 013 1500	80
6.58043.2242	052 013 1525	75
6580 470 125	052 010 1100	78
6.58072.1201	052 010 0975	77
6.58072.1241	052 010 1075	77
6580 721 251	052 010 1100	78
6.58072.1361	052 010 1380	78
6.58072.2231	052 013 1050	75
6.58072.2421	052 013 1525	75
81.00000.0239	014 018 0009	14
81.00000.0246	12-34 323 0006	27
81.05504.0025	12-14 322 0000	14
81.05504.0038	014 018 0009	14
81.05504.0040	014 018 0009	14
81.05504.6001	12-34 632 0001	186
81.06102.6089	12-14 223 0006	65
81.06102.6098	12-14 223 0004	63
81.06102.6099	12-14 223 0004	63
81.06102.6100	12-14 223 0006	65
81.06102.6109	12-14 223 0005	64
81.06102.6110	12-14 223 0001	63
81.06102.6112	12-14 223 0001	63
81.06102.6117	12-14 223 0003	65
81.06102.6201	12-14 223 0004	63
81.06102.6202	12-14 223 0004	63
81.06102.6203	12-14 223 0006	65
81.06102.6204	12-14 223 0005	64
81.06102.6205	12-14 223 0001	63
81.06102.6206	12-14 223 0003	65
81.06102.6208	12-14 223 0003	65
81.06102.6209	12-14 223 0001	63
81.06102.6218	12-14 223 0004	63
81.06102.6219	12-14 223 0005	64
81.06102.6220	12-14 223 0006	65
81.06102.6221	12-14 223 0003	65
81.06102.6222	12-14 223 0001	63

Ref. no.	MEYLE no.	Page
<b>MAN</b>		
81.06102.6226	12-14 223 0003	65
81.06102.6227	12-14 223 0001	63
81.06111.0018	039 238 0001	66
81.06111.0019	12-14 223 0002	37
81.06111.0020	12-14 223 0002	37
81.06601.0042	12-34 232 0016	53
81.06601.0069	12-34 232 0007	53
81.06601.0072	14-34 232 0012	54
81.08304.0038	12-34 321 0010	16
81.08304.0043	12-34 321 0010	16
81.08304.0044	12-34 321 0010	16
81.08304.0046	12-34 321 0008	19
81.08304.0049	012 094 0024	16
81.08304.0051	16-34 321 0010	16
81.08304.0055	012 094 0024	16
81.08304.0056	012 094 0024	16
81.08304.0074	12-34 321 0011	17
81.08304.0076	12-34 321 0011	17
81.08304.0084	12-34 321 0002	17
81.08304.0085	12-34 321 0004	18
81.08304.0086	812 321 0001	18
81.08304.0087	12-34 321 0006	20
81.08304.0091	12-34 321 0010	16
81.08304.0093	12-34 321 0014	18
81.08304.0100	034 321 0009	19
81.08304.0101	12-34 321 0019	19
81.08304.0103	12-34 321 0019	19
81.08401.6213	12-34 321 0010	16
81.08405.0008	12-34 321 0008	19
81.08405.0012	12-34 321 0004	18
81.08405.0015	12-34 321 0006	20
81.08405.0016	12-34 321 0003	21
81.08405.0017	12-34 321 0005	20
81.08405.0018	12-34 321 0009	20
81.08405.0020	12-34 321 0003	21
81.08405.0021	12-34 321 0003	21
81.08405.0022	12-34 321 0017	21
81.08405.0023	12-34 321 0018	21
81.08405.0029	12-34 321 0021	22
81.08405.0030	12-34 321 0022	22
81.11101.6012	034 009 0003	26
81.11101.6013	034 323 0003	27
81.11101.6016	034 009 0003	26
81.11101.6151	034 323 0003	27
81.12102.0002	034 009 0003	26
81.12150.6003	034 009 0015	23



Ref. no.	MEYLE no.	Page
<b>MAN</b>		
81.12150.6013	034 009 0015	23
81.12501.0021	12-34 323 0003	28
81.12501.0022	12-34 323 0004	28
81.12501.0026	12-34 323 0003	28
81.12501.0030	12-34 323 0003	28
81.12501.0031	12-34 323 0005	28
81.12501.0032	12-34 323 0004	28
81.12501.0034	12-34 323 0004	28
81.12503.0021	12-34 323 0006	27
81.12503.0022	12-34 323 0006	27
81.12503.0033	12-34 323 0003	28
81.12503.0042	12-34 323 0006	27
81.12503.0048	12-34 323 0006	27
81.12503.0054	12-34 323 0006	27
81.12503.0063	12-34 323 0006	27
81.12503.0080	12-34 323 0004	28
81.12503.0085	12-34 323 0005	28
81.12503.0086	12-34 323 0003	28
81.15210.0049	12-34 152 0002	89
81.15210.0054	12-34 152 0003	90
81.15210.0056	12-34 152 0007	90
81.15210.0071	12-34 152 0005	90
81.15210.0078	12-34 152 0009	91
81.15700.6006	12-34 157 0008	122
81.15700.9006	12-34 157 0008	122
81.15701.6003	034 043 0005	122
81.15701.6079	12-34 157 0008	122
81.15701.6091	12-34 157 0007	123
81.15701.6099	12-34 157 0007	123
81.15701.6112	12-34 157 0003	122
81.15701.6113	12-34 157 0005	123
81.15701.6116	12-34 157 0007	123
81.15701.6119	12-34 157 0007	123
81.15701.6120	12-34 157 0005	123
81.15701.6124	12-34 157 0004	124
81.24120.6122	12-34 899 0018	111
81.25260.6105	12-34 830 0101	216
81.25503.0244	12-34 029 0001	-
81.25509.0020	12-34 255 0001	203
81.25509.0028	12-34 255 0002	204
81.25509.0067	12-34 255 0002	204
81.25509.0085	12-34 255 0003	205
81.25509.0093	12-34 255 0002	204
81.25509.0118	12-34 255 0003	205
81.25509.0119	12-34 255 0002	204
81.25509.0123	12-34 255 0003	205

Ref. no.	MEYLE no.	Page
<b>MAN</b>		
81.25509.0124	12-34 255 0002	204
81.25509.0125	12-34 255 0009	204
81.25509.0126	12-34 255 0010	205
81.25509.0127	12-34 255 0003	205
81.25509.0128	12-34 255 0003	205
81.25509.0144	12-34 255 0003	205
81.25525.0033	12-34 899 0023	-
81.25525.0227	12-34 899 0023	-
81.25525.0257	12-34 899 0023	-
81.25601.6024	034 015 0005	10
81.25902.0155	12-34 830 0006	225
81.25902.0274	12-34 830 0006	225
81.25902.0460	12-34 830 0005	225
81.25902.0474	12-34 830 0005	225
81.25937.0010	12-34 032 0007	117
81.25937.0015	12-34 032 0007	117
81.25937.0016	834 533 0004	118
81.26440.0029	029 700 2870	223
81.26440.0043	029 700 2870	223
81.26440.0049	029 100 4071	222
81.26440.0053	029 600 2470	223
81.26440.0065	029 600 2470	223
81.26440.6006	029 700 2870	223
81.26440.6016	029 100 4071	222
81.26440.6027	029 100 4071	222
81.26440.6034	029 600 2470	223
81.26440.6035	029 700 2870	223
81.26485.6008	12-34 870 0004	221
81.26485.6027	12-34 870 0002	221
81.26485.6030	12-34 870 0002	221
81.26485.6032	12-34 870 0001	222
81.26485.6033	12-34 870 0001	222
81.27120.0021	12-34 533 0103	103
81.27120.6105	12-34 899 0015	103
81.27120.6106	12-34 899 0016	104
81.27120.6110	12-34 899 0014	106
81.27120.6119	12-34 899 0005	110
81.27120.6121	12-34 899 0017	111
81.27120.6125	12-34 899 0011	107
81.27120.6126	12-34 899 0012	107
81.27120.6137	12-34 899 0013	106
81.27120.6138	12-34 899 0014	106
81.27120.6149	12-34 533 0101	104
81.27120.6156	12-34 533 0100	105
81.27120.6157	12-34 533 0102	105
81.27120.6164	12-34 899 0014	106



Ref. no.	MEYLE no.	Page
<b>MAN</b>		
81.27120.6165	12-34 899 0013	106
81.27120.6168	12-34 899 0012	107
81.27120.6169	12-34 899 0011	107
81.27120.6176	12-34 899 0020	108
81.27120.6177	12-34 899 0021	108
81.27120.6178	12-34 899 0008	109
81.27120.6179	12-34 899 0007	109
81.27120.6182	12-34 899 0005	110
81.27120.6183	12-34 899 0006	110
81.27120.6184	12-34 899 0017	111
81.27120.6185	12-34 899 0018	111
81.27120.6187	12-34 899 0019	112
81.27120.6205	12-34 899 0009	112
81.27120.6206	12-34 899 0010	113
81.27421.0098	12-14 820 0000	11
81.27421.0109	12-14 820 0000	11
81.27421.0152	12-34 223 0001	66
81.27421.0169	12-34 223 0001	66
81.30300.6002	034 600 6000	143
81.30300.6003	034 600 6000	143
81.30530.0037	12-31 106 0004	144
81.30550.0041	12-31 106 6032	141
81.30550.0050	12-31 106 6032	141
81.30550.6019	12-31 106 6032	141
81.30560.0067	12-31 106 0005	143
81.30560.0068	12-31 106 0005	143
81.30560.0070	12-31 106 0003	142
81.30560.0075	12-31 106 0003	142
81.30560.0078	12-31 106 0005	143
81.30560.6019	12-31 106 0001	143
81.30560.6022	12-31 106 0001	143
81.30560.6023	12-31 106 0005	143
81.30560.6024	12-31 106 0005	143
81.30715.6108	12-37 142 0002	147
81.30715.6111	12-37 142 0001	147
81.30715.6119	12-37 142 0001	147
81.30715.6120	12-37 142 0002	147
81.30715.6121	12-37 142 0001	147
81.30725.6007	12-34 725 6025	145
81.30725.6024	12-34 725 6025	145
81.30725.6025	12-34 725 6025	145
81.30725.6026	12-34 725 6025	145
81.30725.6027	12-34 725 6027	145
81.30725.6028	12-34 725 6027	145
81.30725.6031	12-34 725 6032	145
81.30725.6032	12-34 725 6032	145

Ref. no.	MEYLE no.	Page
<b>MAN</b>		
81.30725.6045	12-34 725 6027	145
81.30725.6046	12-34 725 6027	145
81.30725.6053	12-34 725 6032	145
81.30725.6054	12-34 725 6032	145
81.30725.6065	12-37 142 0003	146
81.30725.6084	12-37 142 0004	146
81.30725.6085	12-37 142 0004	146
81.30725.6086	12-37 142 0003	146
81.30725.6092	12-37 142 0004	146
81.30725.6104	034 029 0034	146
81.30725.6107	12-37 142 0004	146
81.30725.6116	12-37 142 0004	146
81.30725.9025	12-34 725 6025	145
81.32411.0006	12-31 106 0002	142
81.32411.0007	12-31 106 0002	142
81.32411.0009	12-31 106 0005	143
81.32550.0003	034 026 0032	137
81.32620.0039	12-34 026 0001	202
81.32620.0043	12-34 026 0001	202
81.32620.0049	12-34 026 0000	202
81.32620.0085	12-34 026 0001	202
81.32734.6001	034 026 0030	133
81.32735.6011	034 026 0025	139
81.32735.6035	034 026 0025	139
81.32735.6039	034 026 0025	139
81.32735.6040	034 026 0025	139
81.35412.6003	12-14 753 0014	135
81.35710.0044	034 035 0003	179
81.35710.0045	034 035 0001	179
81.39108.6048	034 041 9022	140
81.39126.6017	12-34 126 6017	141
81.39126.6020	12-34 126 6020	141
81.39126.6030	12-34 126 6020	141
81.39200.6015	12-34 126 6017	141
81.39374.6003	034 041 9022	140
81.39410.6013	12-34 410 0002	139
81.39410.6017	12-34 410 0002	139
81.39410.6019	12-34 410 0002	139
81.39410.6020	12-34 151 0002	139
81.39410.6023	12-34 151 0003	140
81.39410.6031	12-34 151 0003	140
81.41506.0096	12-34 030 0004	29
81.41700.6095	12-34 058 0003	213
81.41715.6013	12-34 058 0001	213
81.41715.6014	12-34 058 0002	214
81.41723.6059	12-14 910 0102	215



Ref. no.	MEYLE no.	Page
<b>MAN</b>		
81.41723.6103	12-14 910 0102	215
81.41723.6114	12-14 910 0102	215
81.41723.6123	12-14 910 0005	215
81.41723.6124	12-14 910 0004	216
81.41723.9114	12-14 910 0102	215
81.43220.6006	12-34 220 6055	159
81.43220.6030	12-36 030 0004	157
81.43220.6055	12-34 220 6055	159
81.43220.6067	12-36 035 0002	156
81.43220.6068	12-36 035 0002	156
81.43220.6070	12-36 035 0003	157
81.43220.6071	12-36 035 0003	157
81.43220.6072	12-36 035 0003	157
81.43220.6073	12-34 220 6055	159
81.43220.6090	12-36 035 0002	156
81.43220.6091	12-36 035 0003	157
81.43220.6092	12-36 035 0002	156
81.43220.6093	12-36 035 0003	157
81.43220.6096	12-36 030 0004	157
81.43220.6097	12-36 030 0004	157
81.43220.6098	12-36 030 0004	157
81.43220.6107	12-34 220 6055	159
81.43220.6108	12-34 220 6108	160
81.43220.6119	12-36 035 0003	157
81.43220.6120	12-36 035 0002	156
81.43220.6129	12-36 030 0004	157
81.43220.6132	12-34 220 6108	160
81.43220.6139	12-36 030 0016	153
81.43220.6151	12-36 030 0016	153
81.43220.6161	12-36 050 0002	158
81.43220.6183	12-36 030 0016	153
81.43220.6190	12-36 050 0002	158
81.43220.6196	12-36 035 6196	158
81.43220.6197	16-34 653 0001	160
81.43220.6203	14-36 035 0003	160
81.43220.6221	12-34 035 0002	155
81.43220.6222	12-34 050 0003	152
81.43220.6229	12-34 035 0003	159
81.43220.6232	12-36 035 6196	158
81.43220.6233	12-36 035 6196	158
81.43220.6236	12-34 035 0003	159
81.43220.6241	12-34 001 0009	161
81.43220.6244	12-34 250 6244	161
81.43220.6247	12-36 030 0013	152
81.43220.6260	12-34 050 0003	152
81.43220.6267	12-34 035 0003	159

Ref. no.	MEYLE no.	Page
<b>MAN</b>		
81.43220.6268	12-34 050 0002	152
81.43220.6272	12-34 035 0003	159
81.43220.6276	12-36 030 0016	153
81.43220.6277	12-36 030 0016	153
81.43220.6283	12-34 050 0003	152
81.43220.6284	12-34 050 0003	152
81.43220.6291	12-34 050 0002	152
81.43220.6304	12-34 035 0003	159
81.43220.6305	12-34 035 0003	159
81.43220.9092	12-36 035 0002	156
81.43220.9236	12-34 035 0003	159
81.43230.6014	12-36 030 0004	157
81.43230.6051	12-34 230 6051	161
81.43230.6068	12-34 230 6051	161
81.43270.6030	12-36 050 0000	154
81.43270.6034	12-36 050 0000	154
81.43270.6040	034 035 0029	162
81.43270.6045	034 035 0029	162
81.43270.6054	12-36 050 0000	154
81.43270.6056	12-36 050 0001	153
81.43270.6057	12-36 050 0000	154
81.43270.6065	12-34 001 0001	162
81.43270.6067	12-36 050 0001	153
81.43270.6075	12-36 050 0001	153
81.43270.6076	12-36 050 0000	154
81.43270.6077	12-36 050 0001	153
81.43270.6078	12-36 050 0000	154
81.43270.6079	12-34 270 6079	163
81.43270.6080	12-34 301 6132	163
81.43270.6081	12-36 050 0001	153
81.43270.6082	12-36 050 0000	154
81.43270.6083	12-34 301 6133	163
81.43270.6087	12-36 035 6087	154
81.43270.6088	12-36 035 6087	154
81.43270.6094	12-36 035 6087	154
81.43270.6095	12-36 035 6087	154
81.43270.6096	12-34 035 0002	155
81.43270.6097	12-34 050 0001	155
81.43270.6099	12-34 270 6079	163
81.43270.6113	12-34 050 0001	155
81.43270.6114	12-34 035 0002	155
81.43270.6116	12-34 035 0005	156
81.43270.6117	12-34 035 0006	155
81.43270.6135	12-34 050 0001	155
81.43270.6137	12-34 035 0005	156
81.43270.9054	12-36 050 0000	154



Ref. no.	MEYLE no.	Page
<b>MAN</b>		
81.43270.9078	12-36 050 0000	154
81.43271.0008	12-34 271 0029	164
81.43271.0029	12-34 271 0029	164
81.43271.0080	12-34 271 0080	170
81.43271.0081	12-34 271 0081	164
81.43271.0082	12-34 271 0082	170
81.43610.6124	12-34 032 0000	117
81.43610.6129	12-34 032 0000	117
81.43704.0029	12-34 704 0029	171
81.43704.0057	12-34 704 0057	165
81.43704.0060	12-34 704 0060	165
81.43704.0061	12-34 704 0061	165
81.43704.0074	12-34 271 0096	171
81.43704.0077	12-34 271 0095	166
81.43704.0078	12-34 271 0084	171
81.43722.0019	12-34 722 0019	166
81.43722.0021	12-34 722 0021	173
81.43722.0022	12-34 271 0086	172
81.43722.0038	12-34 271 0086	172
81.43722.0039	12-34 722 0021	173
81.43722.0040	12-34 271 0040	167
81.43722.0041	12-34 271 0040	167
81.43722.0042	12-34 271 0040	167
81.43722.0044	12-34 610 0001	149
81.43722.0051	12-34 032 0003	149
81.43722.0052	12-34 271 0101	167
81.43722.0053	12-34 271 0094	167
81.43722.0059	12-34 271 0085	172
81.43722.0060	12-34 032 0003	149
81.43722.0061	12-34 610 0001	149
81.43722.0062	12-34 722 0062	150
81.43722.0063	12-34 722 0021	173
81.43722.0068	12-34 271 0098	173
81.43722.0072	12-34 271 0083	173
81.43722.0081	12-34 722 0021	173
81.43722.0082	12-34 722 0021	173
81.43722.0083	12-34 271 0088	168
81.43722.6051	12-34 722 0019	166
81.44205.6013	12-34 205 6013	148
81.44205.6023	12-34 205 0001	148
81.44205.6025	12-34 798 0001	149
81.45503.0049	034 040 0002	185
81.45503.0056	034 040 0002	185
81.46433.6006	12-34 899 0002	220
81.46433.6011	12-34 899 0002	220
81.46610.6004	12-34 035 0004	192

Ref. no.	MEYLE no.	Page
<b>MAN</b>		
81.46610.6006	12-34 035 0004	192
81.46610.6019	12-34 250 6374/HD	189
81.46610.6087	12-34 250 6197	190
81.46610.6333	12-36 040 0009	191
81.46610.6334	12-36 040 0009	191
81.46610.6354	12-36 040 0009	191
81.46610.6355	12-36 040 0009	191
81.46610.6360	12-36 040 0009	191
81.46610.6361	12-36 040 0009	191
81.46610.6374	12-34 250 6374/HD	189
81.46610.6656	12-34 250 6656	189
81.46610.6659	12-34 250 6656	189
81.46610.6669	12-34 250 6656	189
81.46610.6689	12-36 030 0011/HD	187
81.46610.6720	12-36 030 0011/HD	187
81.46610.6721	12-36 040 0009	191
81.46610.6722	12-36 040 0009	191
81.46610.6723	12-36 040 0009	191
81.46610.6753	12-34 035 0004	192
81.46610.6754	12-34 035 0004	192
81.46610.6767	12-34 250 6767/HD	190
81.46610.6768	12-34 250 6767/HD	190
81.46610.6808	12-34 250 6197	190
81.46610.6809	12-34 250 6135	191
81.46610.6810	12-34 250 6135	191
81.46610.6823	12-34 250 6135	191
81.46610.6836	12-34 250 6197	190
81.46610.6837	12-34 250 6197	190
81.46610.6839	12-34 250 6135	191
81.46611.6014	12-34 250 6767/HD	190
81.46611.6088	12-34 250 6197	190
81.46611.6096	12-34 250 6197	190
81.46611.6097	12-34 250 6197	190
81.46611.6099	12-34 250 6197	190
81.46611.6104	12-34 250 6135	191
81.46611.6105	12-34 250 6135	191
81.46611.6107	12-34 250 6135	191
81.46611.6132	12-34 250 6197	190
81.46611.6133	12-34 250 6197	190
81.46611.6134	12-34 250 6135	191
81.46611.6135	12-34 250 6135	191
81.46611.6136	12-34 250 6197	190
81.46611.6137	12-34 250 6135	191
81.46611.6197	12-34 250 6197	190
81.46611.6198	12-34 250 6197	190
81.46611.6199	12-34 250 6135	191





Ref. no.	MEYLE no.	Page
<b>MAN</b>		
81.46611.6200	12-34 250 6135	191
81.46611.6205	12-34 250 6197	190
81.46611.6206	12-34 250 6135	191
81.46611.6216	12-36 040 0009	191
81.46710.6112	12-36 030 0002 12-36 030 0002/HD	187-188
81.46710.6163	12-36 030 0002 12-36 030 0002/HD	187-188
81.46710.6165	12-36 030 0002 12-36 030 0002/HD	187-188
81.46710.6198	12-36 030 0002 12-36 030 0002/HD	187-188
81.46710.6353	12-36 030 0002 12-36 030 0002/HD	187-188
81.46710.6354	12-36 030 0002 12-36 030 0002/HD	187-188
81.46710.6361	12-36 030 0002	187
81.46710.6418	12-34 250 6418	192
81.46711.6721	12-36 030 0011/HD	187
81.46711.6725	12-36 030 0002 12-36 030 0002/HD	187-188
81.46711.6773	12-34 250 6860	188
81.46711.6791	12-34 250 6860	188
81.46711.6820	12-36 030 0002 12-36 030 0002/HD	187-188
81.46711.6848	12-34 250 6860	188
81.46711.6849	12-36 030 0002 12-36 030 0002/HD	187-188
81.46711.6858	12-34 250 6860	188
81.46711.6859	12-34 250 6860	188
81.46711.6860	12-34 250 6860	188
81.46711.6861	12-34 250 6860	188
81.46711.6862	12-34 250 6860	188
81.46711.6863	12-34 250 6860	188
81.46711.6921	12-34 250 6860	188
81.47101.6000	12-34 471 0001	199
81.47101.6001	12-34 471 0001	199
81.47101.6031	12-34 471 0001	199
81.47101.6040	12-34 471 0001	199
81.47101.6051	12-34 471 0001	199
81.47101.6102	12-34 631 0002	200
81.47101.6108	12-34 631 0002	200
81.47101.6121	12-34 631 0001	200
81.47101.6136	12-34 631 0001	200
81.47101.6137	12-34 471 0003	200
81.47101.6161	12-34 631 0001	200

Ref. no.	MEYLE no.	Page
<b>MAN</b>		
81.47101.6162	12-34 471 0003	200
81.47101.6169	12-34 471 0001	199
81.47101.6181	12-34 471 0003	200
81.47101.6189	12-34 631 0002	200
81.47101.9137	12-34 471 0003	200
81.47101.9162	12-34 471 0003	200
81.47301.6005	034 046 0000	186
81.47301.6048	12-34 632 0002	201
81.47307.0001	12-34 632 0001	186
81.50213.0013	034 042 0017	113
81.50213.6005	034 042 0017	113
81.50213.6006	034 042 0017	113
81.50610.6132	034 042 0029/C	114
81.50802.6017	12-34 042 0014	92
81.50802.6020	12-34 042 0014	92
81.50802.6021	12-34 042 0014	92
81.50802.6022	12-34 042 0015	92
81.50802.6025	12-34 042 0017	92
81.50803.0010	12-35 521 0000	94
81.50803.0020	12-35 521 0005	97
81.50803.0021	12-35 521 0004	96
81.50803.0022	12-35 523 0000	98
81.50803.0023	12-35 521 0002	95
81.50803.0024	12-35 521 0007	94
81.50803.0026	12-35 521 0007	94
81.50803.0027	12-35 521 0005	97
81.50803.0028	12-35 521 0003	97
81.50803.0031	12-35 521 0002	95
81.50803.0033	12-35 521 0002	95
81.50803.0034	12-35 521 0002	95
81.50803.0035	12-35 521 0002	95
81.50803.0036	12-35 521 0002	95
81.50803.0038	12-35 521 0002	95
81.50803.0039	12-35 521 0008	95
81.50803.0040	12-35 521 0002	95
81.50803.0041	12-35 521 0004	96
81.50803.0043	12-35 523 0005	98
81.50803.0044	12-35 521 0012	96
81.50803.0046	12-35 521 0002	95
81.50803.0048	12-35 521 0003	97
81.50803.0057	12-35 521 0005	97
81.50803.0061	12-35 523 0000	98
81.50803.0062	12-35 523 0005	98
81.50820.5006	025 291 1328	101
81.50820.5007	025 291 1328 025 291 1428	99, 101



Ref. no.	MEYLE no.	Page
<b>MAN</b>		
81.50820.5017	025 290 9530	98
81.50820.5020	025 291 1328	101
81.50820.5023	025 290 8826 025 290 8826/S	99–100
81.50820.5025	025 290 8826 025 290 8826/S	99–100
81.50820.5029	025 290 8826 025 290 8826/S	99–100
81.50820.5040	025 291 1328	101
81.50820.5041	025 291 1428	99
81.50820.5047	025 291 1328	101
81.50820.5048	025 291 1428	99
81.50820.5060	025 291 1328	101
81.50820.5061	025 291 1428	99
81.50820.5066	025 291 1328	101
81.50820.5068	025 291 1328	101
81.50820.5069	025 291 1428	99
81.50820.5072	025 291 3130	101
81.50820.5074	025 290 4827	102
81.50820.5079	025 290 8826 025 290 8826/S	99–100
81.50820.5080	025 291 3130	101
81.50820.5085	025 290 4827	102
81.50820.5091	025 291 1328	101
81.50820.5092	025 291 1428	99
81.50820.6000	025 291 1328	101
81.50820.6001	025 291 1428	99
81.50820.6002	025 291 1328	101
81.50820.6003	025 291 1428	99
81.50820.6004	025 291 1328	101
81.50820.6005	025 291 1428	99
81.50820.6006	025 290 8826 025 290 8826/S	99–100
81.50820.6008	025 290 9530	98
81.50820.6014	025 291 1328	101
81.50820.6015	025 291 1428	99
81.50820.6016	025 291 1328	101
81.50820.6017	025 291 1328 025 291 1428	99, 101
81.50820.6020	025 290 8826 025 290 8826/S	99–100
81.50820.6022	025 290 9530	98
81.50820.6025	025 291 1328	101
81.50820.6026	025 291 1428	99
81.50820.6030	025 290 8730 025 290 8730/S	100, 102

Ref. no.	MEYLE no.	Page
<b>MAN</b>		
81.50820.6031	025 291 3130	101
81.50820.6034	025 291 1328	101
81.50820.6035	025 291 1328	101
81.50820.6036	025 291 1328	101
81.50820.6040	025 290 4827	102
81.50820.6041	025 291 3130	101
81.50820.6042	025 290 8826 025 290 8826/S	99–100
81.50820.6043	025 290 4827	102
81.50820.6046	025 291 1328	101
81.50820.6051	025 291 3130	101
81.50820.6054	025 290 4827	102
81.50820.6056	025 290 8730 025 290 8730/S	100, 102
81.50820.6063	025 290 4827	102
81.50822.6009	12-34 042 0010	93
81.50822.6011	12-34 527 0001	102
81.50822.6016	12-34 527 0001	102
81.50822.6019	12-34 042 0021	94
81.50822.6020	12-34 042 0012	93
81.50822.6022	034 042 0053	93
81.50822.6031	12-34 042 0012	93
81.50822.6032	034 042 0053	93
81.50822.6034	12-34 042 0021	94
81.50822.6037	12-34 042 0021	94
81.51101.6485	12-34 899 0018	111
81.51113.0001	034 043 0002	127
81.51113.0012	034 042 0061	127
81.51113.0013	034 042 0030	128
81.51113.0014	034 042 0043	128
81.51113.0020	034 042 0062	128
81.51220.6024	034 042 0033	118
81.51220.6025	034 042 0034	118
81.51220.6032	034 042 0039	119
81.51220.6069	034 042 0039	119
81.51220.6093	034 042 0039	119
81.51220.6096	034 042 0039	119
81.51270.6002	034 042 0024	121
81.52101.6153	12-35 533 0000	120
81.52101.6154	12-35 533 0000	120
81.52101.6241	034 043 0056	116
81.52101.6246	034 043 0056	116
81.52101.6269	12-35 533 0001	120
81.52101.6270	12-35 533 0002	121
81.52101.6275	034 043 0056	116
81.52102.0008	034 042 0032	117



Ref. no.	MEYLE no.	Page
<b>MAN</b>		
81.52108.6001	12-34 042 0026	116
81.52108.6025	12-34 042 0026	116
81.52110.6049	12-35 533 0003	119
81.52110.6095	12-35 533 0003	119
81.52115.6009	034 042 0048	119
81.52115.6017	034 042 0048	119
81.52115.6018	034 042 0048	119
81.52115.6021	034 042 0048	119
81.52116.6010	034 042 0007	131
81.52116.6037	034 042 0007	131
81.52116.6067	12-34 043 0001	131
81.52116.6068	12-34 043 0001	131
81.52116.6069	12-34 043 0001	131
81.52116.6070	034 043 0070	131
81.52116.6071	12-35 533 0004	132
81.52116.6074	034 043 0066	132
81.52116.6075	034 043 0066	132
81.52116.9075	034 043 0066	132
81.52120.6003	034 042 0051	125
81.52120.6004	034 042 0051	125
81.52120.6025	034 042 0051	125
81.52120.6028	034 042 0051	125
81.52120.6029	034 042 0051	125
81.52120.6030	034 042 0051	125
81.52120.6040	034 042 0051	125
81.52120.6075	034 042 0051	125
81.52131.6015	12-34 026 0002	130
81.52151.6093	12-35 533 0005	124
81.52151.6094	12-35 533 0034	124
81.52151.6096	12-35 533 0005	124
81.52155.0040	12-34 042 0026	116
81.52155.0041	12-34 042 0026	116
81.52170.6064	034 026 0027	130
81.52170.6095	034 026 0029	138
81.52170.6096	12-37 142 0007	133
81.52170.6097	034 026 0029	138
81.52170.6120	034 026 0030	133
81.52170.6128	034 026 0027	130
81.52170.6139	12-34 026 0002	130
81.52170.6151	12-34 026 0002	130
81.52170.6156	12-37 142 0007	133
81.52301.6120	12-35 533 0037	126
81.52301.6121	12-35 533 0037	126
81.52301.6148	12-34 043 0002	126
81.52301.6183	12-35 533 0007	125
81.52301.6189	12-35 533 0007	125

Ref. no.	MEYLE no.	Page
<b>MAN</b>		
81.52301.6192	12-35 533 0007	125
81.52301.9148	12-34 043 0002	126
81.52310.6165	12-35 533 0037	126
81.52315.6156	12-35 533 0031	127
81.52315.6160	12-35 533 0031	127
81.52315.6161	12-35 533 0031	127
81.52403.6001	12-14 653 0001	182
81.54124.6006	034 013 0008	114
81.54124.6013	12-14 013 0001	115
81.54124.6017	12-14 013 0001	115
81.61851.6019	12-14 910 0001	208
81.61851.6023	12-14 910 0001	208
81.61851.6029	12-14 910 0001	208
81.61910.0011	12-12 319 0000	206
81.61910.0018	12-12 319 0003	206
81.61910.0019	12-12 320 0008	206
81.62640.6045	12-34 910 0010	220
81.62640.6046	12-34 910 0011	221
81.62640.6049	12-34 910 0010	220
81.62640.6050	12-34 910 0011	221
81.62640.6055	12-34 910 0010	220
81.62640.6056	12-34 910 0011	221
81.62641.0099	12-34 910 0005	217
81.62641.0100	12-34 910 0006	217
81.62641.6085	12-34 910 0001	218
81.62641.6086	12-34 910 0002	218
81.62680.6095	12-34 910 0009	219
81.62680.6096	12-34 910 0008	219
81.70701.0331	029 700 2870	223
81.74821.0109	12-34 920 1002	216
81.77910.0012	12-12 319 0009	207
81.77910.0027	12-12 319 0009	207
81.77972.0155	12-12 319 0009	207
81.85301.0076	036 020 0015	198
81.90712.0844	12-34 089 0001	209
81.90713.0909	12-34 089 0001	209
81.90801.0224	034 035 0005	178
81.93021.0424	12-31 106 0005	143
81.93420.0078	12-14 650 0005	174
81.93420.0131	034 650 0001	174
81.93420.0288	12-14 650 0006	176
81.93420.0320	12-14 751 0006	176
81.93420.0330	12-14 650 0006	176
81.93420.0336	034 650 0020	177
	12-34 751 0001	
81.93420.0342	12-14 751 0006	176



Ref. no.	MEYLE no.	Page
<b>MAN</b>		
81.93420.0346	12-14 751 0007	177
81.93420.0349	12-14 650 0006	176
81.93420.0376	12-14 751 0006	176
81.93420.0379	034 650 0020	177
81.93420.6083	034 650 0020	177
81.93420.6097	12-14 751 0006	176
81.93420.6099	034 650 0020	177
81.95301.0013	036 020 0002	196
81.95301.0014	036 020 0001	195
81.95301.0015	036 020 0005 036 020 0005/HD	196-197
81.95301.0016	036 020 0004 036 020 0004/HD	193-194
81.95301.0038	034 026 0015	137
81.95301.0045	036 026 0016	136
81.95301.0064	036 020 0001	195
81.95301.0074	036 020 0002	196
81.95301.0077	036 020 0016	198
81.95301.0078	036 020 0015	198
81.95301.0079	036 020 0008	193
81.95301.0084	036 020 0004 036 020 0004/HD	193-194
81.95301.0388	036 020 0016	198
81.95301.6016	034 026 0015 036 026 0016	136-137
81.95301.6030	036 020 0005 036 020 0005/HD	196-197
81.95301.6043	036 020 0005 036 020 0005/HD	196-197
81.95301.6048	036 020 0004 036 020 0004/HD	193-194
81.95301.6049	036 020 0004 036 020 0004/HD	193-194
81.95301.6053	036 020 0004 036 020 0004/HD	193-194
81.95301.6060	036 020 0003	199
81.95301.6061	036 020 0004 036 020 0004/HD	193-194
81.95301.6063	034 026 0017	137
81.95301.6064	034 026 0018	136
81.95301.6067	036 020 0001	195
81.95301.6068	036 020 0002	196
81.95301.6090	036 020 0004 036 020 0004/HD	193-194
81.95301.6091	036 020 0005 036 020 0005/HD	196-197

Ref. no.	MEYLE no.	Page
<b>MAN</b>		
81.95301.6112	036 020 0004 036 020 0004/HD	193-194
81.95301.6120	036 020 0005 036 020 0005/HD	196-197
81.95301.6125	036 020 0005 036 020 0005/HD	196-197
81.95301.6126	036 020 0004 036 020 0004/HD	193-194
81.95301.6130	034 026 0018	136
81.95301.6131	034 026 0017	137
81.95301.6132	12-34 301 6132	163
81.95301.6133	12-34 301 6133	163
81.95301.6134	036 020 0016	198
81.95301.6135	036 020 0003	199
81.95301.6139	036 020 0008	193
81.95301.6140	036 020 0003	199
81.95301.6141	036 020 0015	198
81.95301.6142	036 020 0016	198
81.95301.6143	036 020 0004 036 020 0004/HD	193-194
81.95301.6149	036 020 0004 036 020 0004/HD	193-194
81.95301.6152	036 020 0005 036 020 0005/HD	196-197
81.95301.6154	036 020 0004 036 020 0004/HD	193-194
81.95301.6155	036 020 0005 036 020 0005/HD	196-197
81.95301.6156	036 020 0004 036 020 0004/HD	193-194
81.95301.6162	036 020 0001	195
81.95301.6163	036 020 0002	196
81.95301.6167	036 020 0005 036 020 0005/HD	196-197
81.95301.6169	034 026 0015 036 026 0016	136-137
81.95301.6170	034 026 0018	136
81.95301.6171	034 026 0017	137
81.95301.6172	034 026 0015 036 026 0016	136-137
81.95301.6173	034 026 0018	136
81.95301.6174	034 026 0017	137
81.95301.6176	034 026 0015 036 026 0016	136-137
81.95301.6179	036 020 0005 036 020 0005/HD	196-197



Ref. no.	MEYLE no.	Page
<b>MAN</b>		
81.95301.6194	036 020 0004 036 020 0004/HD	193-194
81.95301.6222	036 020 0008	193
81.95301.6224	036 020 0004 036 020 0004/HD	193-194
81.95301.6234	036 020 0004 036 020 0004/HD	193-194
81.95301.6235	034 026 0015	137
81.95301.6237	036 020 0005 036 020 0005/HD	196-197
81.95301.6239	036 020 0001	195
81.95301.6242	036 020 0004 036 020 0004/HD	193-194
81.95301.6249	036 020 0003	199
81.95301.6263	12-36 020 0032	194
81.95301.6266	036 026 0016	136
81.95301.6269	036 026 0016	136
81.95301.6270	12-36 020 0039	195
81.95301.6272	036 020 0001	195
81.95301.6273	036 020 0002	196
81.95301.6274	036 020 0004 036 020 0004/HD	193-194
81.95301.6275	036 020 0005 036 020 0005/HD	196-197
81.95301.6278	036 020 0004 036 020 0004/HD	193-194
81.95301.6288	12-36 020 0041	197
81.95301.6303	036 020 0016	198
81.95301.6304	036 020 0015	198
81.95301.6308	036 020 0004 036 020 0004/HD	193-194
81.95301.6312	036 020 0004 036 020 0004/HD	193-194
81.95301.6315	036 020 0008	193
81.95301.6321	036 020 0016	198
81.95301.6328	036 020 0003	199
81.95301.6329	036 020 0008	193
81.95301.6350	036 020 0004 036 020 0004/HD	193-194
81.95301.6352	036 020 0004	193
81.95301.6358	036 020 0003	199
81.95301.6359	036 020 0008	193
81.95302.0038	16-34 653 0001	160
81.95302.0057	16-34 653 0001	160
81.95302.0079	12-31 106 0006	144
81.95302.0080	12-31 106 0006	144

Ref. no.	MEYLE no.	Page
<b>MAN</b>		
81.96020.0202	12-34 030 0011	30
81.96020.0205	12-34 030 0009	29
81.96020.0231	12-34 032 0002	150
81.96020.0235	12-34 030 0009	29
81.96020.0239	12-34 030 0011	30
81.96020.0250	12-34 032 0002	150
81.96020.0252	12-34 032 0002	150
81.96020.0340	12-34 030 0012	30
81.96020.0341	12-34 030 0007	30
81.96020.0372	12-34 030 0012	30
81.96020.0373	12-34 030 0007	30
81.96020.0382	12-34 030 0009	29
81.96020.0391	12-34 030 0013	31
81.96020.0402	12-34 030 0006	31
81.96020.0403	12-34 030 0013	31
81.96020.0408	12-34 030 0007	30
81.96101.0638	12-34 210 0401	209
81.96210.0294	12-34 271 0100	168
81.96210.0340	12-34 210 0348	208
81.96210.0348	12-34 210 0348	208
81.96210.0349	12-34 210 0348	208
81.96210.0362	12-34 058 0004	214
81.96210.0369	12-34 210 0403	208
81.96210.0388	12-34 030 0008	32
81.96210.0400	12-34 210 0400	210
81.96210.0407	12-34 058 0004	214
81.96210.0424	12-34 210 0437	210
81.96210.0437	12-34 210 0437	210
81.96210.0450	12-34 271 0086	172
81.96210.0462	12-34 210 0403	208
81.96210.0469	12-34 271 0086	172
81.96210.0482	12-34 210 0515	212
81.96210.0494	12-34 030 0008	32
81.96210.0495	12-34 030 0008	32
81.96210.0515	12-34 210 0515	212
81.96210.0525	12-34 030 0000	32
81.96210.0553	12-34 030 0000	32
81.96210.0554	12-34 742 0000	150
81.96210.0555	12-34 742 0001	151
81.96210.0562	12-34 030 0003	32
81.96210.0571	12-34 030 0003	32
81.96210.0572	12-34 030 0002	33
81.96210.0574	12-34 030 0000	32
81.96210.0575	12-34 030 0003	32
81.96210.0577	12-34 030 0003	32
81.96210.0592	12-34 030 0002	33



Ref. no.	MEYLE no.	Page
<b>MAN</b>		
81.96210.0597	12-34 030 0002	33
81.96210.5022	12-34 742 0006	151
81.96210.5025	12-34 742 0005	151
81.96210.5026	12-34 742 0005	151
81.96210.5027	12-34 742 0005	151
81.96210.6065	12-34 030 0001	33
81.96210.6071	12-34 030 0001	33
81.96210.6072	12-34 030 0001	33
81.96301.0496	12-39 222 0001	68
81.96301.0581	12-39 222 0014	67
81.96301.0582	12-39 222 0015	68
81.96301.0621	12-39 222 0015	68
81.96301.0659	12-39 222 0001	68
81.96301.0676	12-39 222 0014	67
81.96301.0677	12-39 222 0005	68
81.96301.0679	12-39 222 0018	69
81.96301.0680	12-39 222 0017	69
81.96301.0892	12-39 222 0008	69
81.96301.0893	12-39 222 0007	70
81.96301.0898	12-39 222 0006	70
81.96305.0088	12-39 222 0003	70
81.96305.0095	12-39 222 0013	71
81.96305.0129	12-39 222 0004	71
81.96305.0130	12-39 222 0020	72
81.96305.0134	12-39 222 0013	71
81.96305.0166	12-39 222 0016	71
81.96305.0169	12-39 222 0020	72
81.96305.0223	12-39 222 0013	71
81.96305.0226	12-39 222 0013	71
81.96305.0227	12-39 222 0009	72
81.96305.0230	12-39 222 0011	73
81.96501.0861	12-14 753 0004	182
81.96501.0907	12-34 279 0073	134
81.96502.6052	12-14 753 0013	134
81.96502.6066	12-14 753 0013	134
81.96502.6081	12-14 653 0000	182
81.96503.0129	12-34 210 0402	213
81.96503.0154	12-34 753 0000	180
81.96503.0155	034 753 0017	183
81.96503.0161	12-14 753 0005	183
81.96503.0188	12-14 753 0006	184
81.96503.0333	12-14 753 0008	184
81.96503.0339	12-14 753 0009	184
81.96503.0398	12-14 753 0006	184
81.96503.0399	12-14 753 0008	184
81.96503.0445	12-14 753 0009	184

Ref. no.	MEYLE no.	Page
<b>MAN</b>		
81.96503.0530	12-14 753 0009	184
81.96503.6000	12-14 753 0010	185
81.96506.0155	12-14 753 0004	182
81.96601.0298	034 035 0013	178
81.96820.0047	050 012 1630	87
81.96820.0051	050 008 0855	88
81.97010.6010	12-34 026 0004	202
81.97010.6011	12-34 026 0003	203
81.97100.6034	12-34 899 0002	220
81.97100.6079	12-34 910 0003	218
81.97100.6095	12-34 899 0002	220
81.97100.6099	12-34 910 0003	218
81.99917.8470	12-34 126 6020	141
82.05504.6001	12-34 632 0001	186
82.05504.6096	12-14 322 0001	14
82.12503.0042	12-14 323 0002	24
82.12503.0069	12-34 323 0005	28
82.46610.6080	12-34 250 6374/HD	189
82.46610.6189	12-34 250 6374/HD	189
82.46610.6190	12-34 250 6374/HD	189
82.52102.0013	034 042 0032	117
82.58000.0060	12-34 043 0002	126
82.96301.0006	12-39 222 0006	70
82.96301.0008	12-39 222 0001	68
83.26440.0001	029 100 4071	222
83.41723.6123	12-14 910 0005	215
83.41723.6124	12-14 910 0004	216
83.43722.0001	12-34 610 0001	149
83.77910.0526	12-12 319 0009	207
84.26440.0003	029 700 2870	223
85.12501.0002	12-34 323 0004	28
85.20000.9975	029 600 2470	223
85.26440.0046	029 600 2470	223
85.30001.6535	034 042 0051	125
85.30001.9636	14-34 043 0001	138
85.32734.6001	14-34 043 0001	138
85.41715.0006	12-34 210 0409	210
85.41723.6011	12-14 910 0100	215
85.41723.6020	12-14 910 0100	215
85.43704.0002	12-34 271 0089	169
85.43704.0004	12-34 271 0090	169
85.43704.0005	12-34 271 0092	169
85.43722.0007	12-34 271 0091	170
85.46610.6031	12-34 035 0004	192
85.46610.6104	12-34 035 0004	192
85.46610.6203	12-34 035 0004	192



Ref. no.	MEYLE no.	Page
<b>MAN</b>		
85.61950.0025	12-12 319 0001	207
85.93020.0005	12-34 271 0094	167
85.94299.0015	12-34 210 0404	211
85.96020.0004	12-34 210 0405	211
85.96210.0019	12-34 210 0406	211
85.96210.0021	12-34 210 0408	212
87.52330.0200	12-14 650 0002	175
87.52340.0820	034 650 0001	174
87.52340.1240	034 650 0000	175
88.52120.6200	034 042 0051	125
88.96210.0004	12-34 030 0009	29
88.96820.0001	050 006 2200	88
90.80415.3107	036 020 0002	196
90.80415.3111	036 020 0001	195
90.80415.3113	036 020 0002	196
90.81011.4192	034 042 0048	119
90.91157.8013	034 042 0001	129
90.91159.0013	034 042 0003	129
99.10036.0792	034 042 0043	128
N1.01100.1840	050 008 1908	88
N1.01100.1846	050 006 1180	89
N1.01100.8494	12-39 222 0026	66
N2.93021.0137	12-31 106 0005	143



# MEYLE – premium quality

## for vehicle classes from S to XXL



Whether passenger car, van or commercial vehicle parts – MEYLE is always a smart choice. Because products of the MEYLE brand stand for outstanding quality and enhanced performance. From production to delivery MEYLE spare parts are subjected to subsequent multi-stage testing to ensure our products meet the stringent quality standards of a German manufacturer.

### Notes

This catalogue is protected by copyright. Reproduction of text, graphic elements, photographs and/or data, even in part, is prohibited. MEYLE, , or parts thereof, are registered trademarks of Wulf Gaertner Autoparts AG.

All supplies and services are subject to our General Terms and Conditions. The original spare part numbers shown in this catalogue are for cross-reference purposes only and shall not be disclosed to third parties on invoices and delivery notes. While the information in this catalogue was compiled and edited with utmost care we do not assume responsibility or accept claims arising from errors or inconsistencies. Subject to technical and/or design changes.

This issue of the catalogue supersedes all previous issues.  
All rights reserved. © 2015 Wulf Gaertner Autoparts AG



Simply lasts longer.